

# Advantech CompactPCI Solutions

At the Core of Business and  
Mission Critical Applications

- / Customized COTS
- / CompactPCI PlusIO
- / 3U/6U Boards and Systems
- / Cross Industry Applications
- / System Integration
- / Ruggedized Boards
- / Design Quality Assurance
- / Global Services



**ADVANTECH**

*Enabling an Intelligent Planet*



[www.advantech.com/nc](http://www.advantech.com/nc)



## Secure Your Long Term Success with Advantech CompactPCI and PlusIO

Since its inception back in the mid 1990's CompactPCI<sup>®</sup> has worked its way into some of the most mission critical applications on this planet. It can be found at the nerve-centre of the world's most hi-tech trains, at the core of the telecommunication network, switching calls and providing critical signalling information in essential core network elements. In both its commercial and ruggedized form, CompactPCI controls industrial and chemical plants, while in the military arena it is employed for battle coordination managing vital communications and command functionality. Many top tier equipment providers have been deploying Advantech CompactPCI platforms within systems like these; systems upon which the world's networking infrastructure still relies, and upon which chemical plants and power stations depend for the safe and secure continuation of their processes. Advantech has been a key player in CompactPCI development for well over a decade now, assisting rugged and industrial OEMs as well as telecom equipment manufacturers to design and integrate CompactPCI in their business and mission critical systems. We understand the impact which the discontinuation of a component can have on a customer's product portfolio and we have solid lifecycle management processes in place to handle it. We've also learnt how to step in when a key supplier announces the end of a product line and a second source blade is urgently needed which meets the same form, fit and function.

### Stability

- Continued investment in CompactPCI
- Ensure longevity of supply
- Offer clear EOL upgrade alternatives
- Protect customer investments

### Evolution

- Expand CPCI Serial & PlusIO solutions
- Continue to broaden CPU and I/O card portfolio
- Provide a seamless migration path for customers

### Flexibility

- Broad range of COTS Solutions
- System Integration
- Apply C<sup>2</sup>OTS for customer specific optimizations
- Open ODM model for proprietary designs

At Advantech our CompactPCI team is committed to providing long-term technology support and timely new product introductions so that our customers can choose when to upgrade their equipment based on strategy and market demands, well ahead of silicon end-of-life scenarios.

This brochure provides you with an overview of our key products; 3U and 6U boards along with 3U and 6U chassis. Span the central pages for you to discover a broad selection of processing power and I/O and typical applications in which they are deployed.



## Customized COTS

### – Just What You Need When You Have a Unique Problem to Solve

Customization at Advantech doesn't just stop at branding. We realise that no two suppliers' seemingly identical CompactPCI blades are exactly the same and that features may differ in various ways like a missing I/O port or connector or often custom IPMI features which aren't implemented. That's where our Customized COTS (C<sup>2</sup>OTS) program comes into play. Because we design our standard products with later customization in mind our processes are tailored to support the customized COTS business model. We offer significant flexibility over a "standard-product-only" roadmap by supporting changes ranging from branding, cost optimization, mechanical and schematic changes as well as the integration of a customer's proprietary IP. We believe that this modus operandi is critical to the long term success of CompactPCI and have adapted our development and manufacturing strategies to encourage customization innovation, delivering complex CompactPCI products uniquely tailored to meet customer's needs without sacrificing the economy of scale offered by standard off-the-shelf products.

Advantech's broad range of products and services allows us to adapt to the level of integration and customization appropriate to each customer's requirements and business model. With Customized COTS we believe that we can help keep your CompactPCI based designs at the core of mission critical operations well in to the future.

#### Your OEM Blade

There's almost always a special feature that your customer needs you to integrate to meet a specific requirement. Its been that way since CompactPCI started and spans back even further to the early days of VMEbus. Mezzanine card technology has evolved in various form factors and with different interconnects helps address the problems caused by over-customization. But when the rubber meets the road and you can't find that feature on COTS products, you need a partner who is ready to go the extra mile and is geared to helping you re-engineer a product to meet your needs. Advantech's CompactPCI customization team is here to identify and scope your special requests. Some examples of special requests that we have implemented for customers are described below:

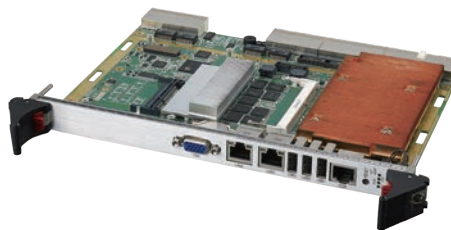

#### Customization Showcases Leveraging Customized COTS (C<sup>2</sup>OTS)

- Adapt CompactPCI SBC to operate with +5V power supply only
- Modify number of Gigabit Ethernet port from two to one copper interface
- Change J5 connector to meet OEM-specific parallel interface requirements, customize BIOS settings and add custom code for setting up custom RTM hardware
- Removal of J3/4/5 on 6U SBC – optimize I/O for front panel connections only
- Replace RJ45 console port to DB9 connector
- Add extra GPIO pins and serial ports to meet OEM specific requirements

# Next Generation CompactPCI Solutions

Using Advantech CompactPCI PlusIO solutions provides a backward compatible migration path for your proven CompactPCI solutions to newly designed, high speed serial peripherals based on CompactPCI Serial.

CompactPCI is a field proven technology with a 15 year history of providing a robust foundation for industrial, medical, telecommunications, aerospace, measurement and transportation applications. The original architecture used a parallel bus to connect a system slot to seven peripheral slots and was a rugged, modular, low power, low cost solution for an ever growing list of applications. Based on the PICMG 2.0 standard, CompactPCI (CPCI) attracted a large ecosystem of vendors providing off-the-shelf products further cost-optimizing the CPCI-based solutions and expanding its market.

## Technology Drives New Standards

Over the years, the PICMG 2.0 standard was extended to meet new requirements and include new technologies and standards. Examples include Hot Swap (PICMG 2.1), Telephony signaling (PICMG 2.5), Management (PICMG 2.9), and Multicomputing (PICMG 2.14). The original parallel bus architecture was also extended to include a packet-based switching architecture (Switched Ethernet, PICMG 2.16) on top of CPCI.

With technology advances, vendors began to include high speed serial point-to-point connections to standard interfaces such as PCI Express®, SATA, SAS, USB and Ethernet. Originally, serial point-to-point connections were realized using user-defined pins on one of the CPCI connectors. This led to compatibility problems within the CPCI ecosystem and drove the need for 2 new PICMG standards:

1. CompactPCI PlusIO (PICMG 2.30) to standardize the peripheral interconnect (eliminate the user-defined pin problem).
2. CompactPCI Serial (PICMG CPCI-S.0) which includes support for serial point-to-point fabrics such as PCI Express, SATA, Ethernet and USB in the CPCI form factor.

### Key requirements for the new standards included:

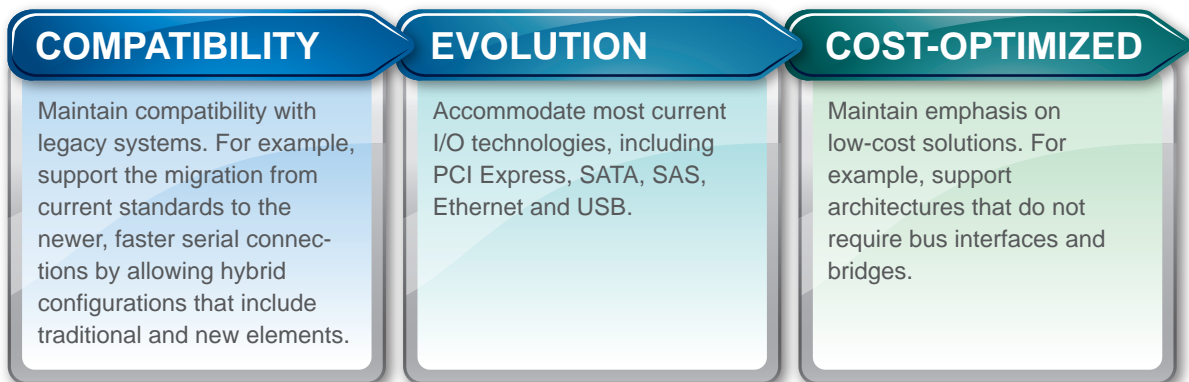

## PICMG 2.30 CompactPCI PlusIO

The goal of the PICMG 2.30 specification is to address the 'user-defined pin' problem associated with serial interfaces. To accomplish this, a new 2-mm-connector is specified to support the higher speed (5 Gb/s) signals. The new connector supports a total of 14 backplane connections: 4 PCI Express x1 links, 4 SATA, 4USB 2.0 and 2 Ethernet 1000 BaseT.

Most importantly, the new connector is 100% mechanically compatible older connectors meaning that hybrid systems that include a mixture of PICMG2.30 and PICMG 2.0 boards thus offering an ideal migration path to the new serial standards.

# PICMG CPCI-S.0 CompactPCI Serial

With the PICMG CPCI-S.0 specification, the original parallel bus is replaced by a system slot with up to 8 high-speed serial interconnects in a star topology. A new, backward compatible connector capable of 12 Gb/s was introduced to handle the larger number of high-speed peripherals. This base system does not require switches or bridges keeping costs low.

## The system slot supports:

- 8 PCI Express links (6 by 4 lanes, 2 by 8 lanes)
- 8 SATA/SAS, 8 USB 2.0/3.0
- 8 Ethernet interfaces
- Signals for general system management including: reset, IPMB, hot plug, geographical addressing, etc
- Supplied with 12V (60W per 3U, 120W per 6U slot)

## Each peripheral slot supports:

- 1 PCI Express link
- 1 SATA/SAS
- 1 USB 2.0/3.0 interface
- Each slot can support up to 8 Ethernet 10GbaseT interfaces to build a full mesh
- All interfaces are accessible simultaneously
- Supplied with 12V (60W per 3U, 120W per 6U slot)



A CompactPCI PlusIO system can include up to 4 of the new CompactPCI Serial slots on a hybrid backplane. A hybrid system that includes CompactPCI, CompactPCI Express and CompactPCI Serial slots offers the most flexible foundation for the migration of existing solutions possible. The following figure illustrates a CompactPCI/CompactPCI PlusIO 8-slot hybrid backplane.

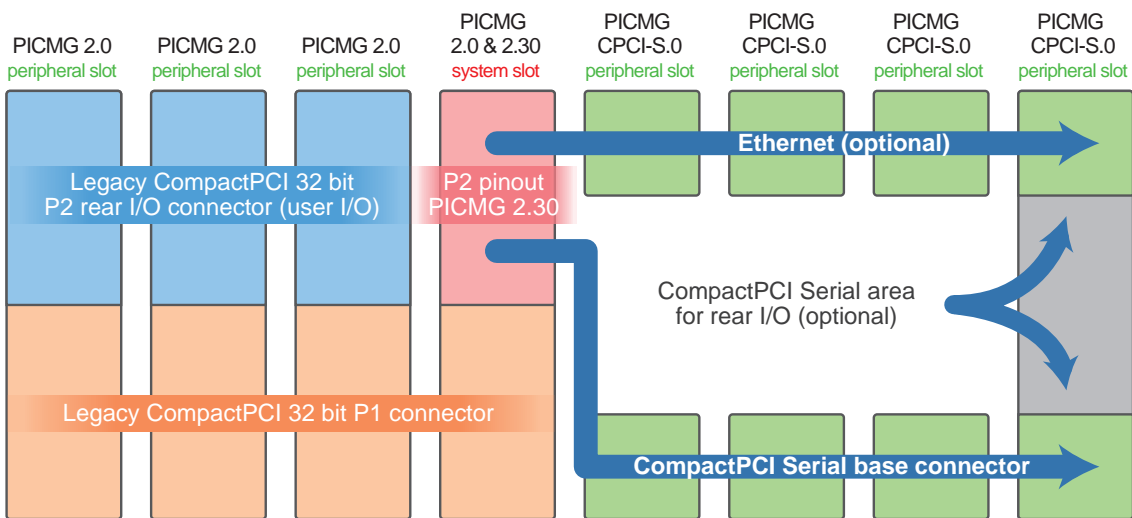

Images courtesy of PICMG

# CompactPCI PlusIO Solutions

Advantech has a long tradition of driving platform innovation in multiple form factors using industry-leading processor architectures. Our commitment to extending the lifetime of our customer's CompactPCI solutions is no different. Our products support a smooth transition path to new technologies and we support our customer's migration with reference platforms and integrated systems.

## Advantech MIC-3328: 3U CompactPCI PlusIO Intel® Core™ i7 Processor Blade

Targeting a broad range of cross-industry applications the Advantech MIC-3328 offers the advantage of a successfully field-tested and proven core design already deployed by Advantech customers in other form factors. The board is designed for mission critical operations with up to 8GB DDR3 ECC memory soldered on board higher reliability, up to 32GB soldered flash for data logging and Intel® AMT 8.0 including KVM for remote troubleshooting and recovery.

Based on the Intel® Core™ i7 3555LE, the MIC-3328 offers a smooth performance upgrade and migration path from traditional CompactPCI, protecting your investments whilst giving you access to the latest high speed bus interfaces in the same system that hosts your legacy I/O boards. System architects can leverage the MIC-3328 in a staged technology upgrade approach, re-using well qualified hardware and software in hybrid CompactPCI PlusIO systems.

### Advantech MIC-3328 At-A-Glance

- Supports 3rd Generation Intel® Core™ processor
- Intel® QM77 Platform Controller Hub
- 4GB DDR3-1600 soldered SDRAM with ECC (max 8GB)
- Triple independent display support
- Two COM ports, 2 Display ports, 1 PS/2 port (8HP)
- 2.5" SATA-II SSD, CFast, XMC on 8HP version
- Optional 8GB SATA NAND Flash on board
- Two 10/100/1000Mbps ports, two USB 3.0 ports, 1 VGA port on front panel (4HP)
- PICMG2.0,R3.0 , PICMG2.1,R2.0, PICMG2.30 compliant

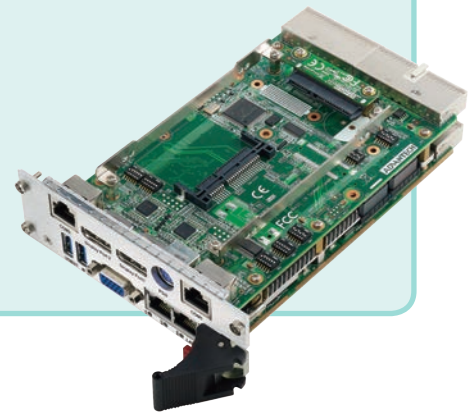

The board fits in a standard 4HP slot and provides front panel connectivity to VGA, two USB 3.0 ports and two RJ-45 gigabit Ethernet ports. Legacy 32-bits 33MHz PCI is ensured by a P17CX110 bridge connecting the board to the CompactPCI J1 connector while the new Ultra Hard Metric (UHM) J2 connector transports the high-speed serial signals from the onboard Mobile Intel® QM77 Express Chipset to the CompactPCI Serial peripheral slots on the backplane or a rear transition module.

High speeds signals such as PCI Express, Gigabit Ethernet, SATA 3 and USB, allow expansion from a growing base of 3rd party boards in order to implement interfaces requiring higher bandwidth or to upgrade PCI components at the end of their lifecycle. The SATA signals on the backplane now allow for RAID systems to be built-in, while USB facilitates the integration of off-the-shelf wireless modules like WiFi or cellular network mezzanines for applications such as M2M.

## Advantech MIC-3022 4U CompactPCI Enclosure for 3U Cards

The MIC-3022 is a 4U enclosure designed to host up to 8 CompactPCI 3U cards connected via a 32bit 33MHz or 66MHz PCI bus. The chassis can be powered by PICMG2.11 CPCI power supplies or an ATX 400W power supply for cost sensitive applications. A CPCI power supply supports a wide range of applications in the industrial market requiring a robust, compact and reliable platform. Rear transition modules can be installed in each of the 8 slots to support IO extension.

Four high performance fans provide adequate air flow to all slots, enabling system configurations which can be used in extended temperature environments. With the support of front swappable power supplies and add-in cards as well as a simplified fan replacement mechanism built in, systems based on the MIC-3022 can support a MTTR of 5 minutes or less.

### Advantech MIC-3022 At-A-Glance

#### CompactPCI 8 slots Plus IO backplane

- System slot middle
- 3 legacy CompactPCI peripheral slots+ 1 Legacy & CompactPCI Serial shared CompactPCI Plus IO system slot + 4 CompactPCI Serial peripheral slots
- 3 legacy CompactPCI peripheral slots with 80mm rear IO support
- CPCI : 32bit/33MHz, 33/66MHz;
- CPCI-S: 5Gb/s
- Selectable VIO (3.3V/5V)

#### Compliance

- PICMG 2.0 R3.0
- PICMG 2.1 R2.0
- PICMG 2.11 R3.0
- PICMG 2.30 CPCI PlusIO
- PICMG CPCI Serial (CPCI S.0)
- RoHS, CE, FCC, UL, CCC



## Advantech: Leading the CompactPCI Evolution, Preserving Your Legacy

At Advantech, we realize that the transition to serial interfaces does not happen overnight. Customers have made significant investment into the CompactPCI platform, both in hardware and even more importantly the related software. With our CompactPCI PlusIO and CompactPCI Serial solutions, we can offer a soft migration path that protects your investments but also takes them a step forward - by giving you the ability to utilize the latest high speed bus interfaces available from Advantech and the CompactPCI ecosystem in the same system that hosts your legacy IO boards. Our focus on allowing you to reuse well qualified platform building blocks like special purpose I/O cards along with the related software in these hybrid systems helps you to stay within your R&D budgets, meet your time-to-market objectives and mitigate risk.

# 3U CompactPCI and PlusIO Boards

## A Broad Selection of Boards to Meet All Your 3U Processing and IO Needs



Advantech offers a complete range of 3U CompactPCI products including Chassis, Single Board Computers and Industrial and Networking I/O. All products support the hot swap of boards while a system is operating enabling a solid foundation for the implementation of mission critical systems. Advantech's latest CompactPCI Serial offering migrates customers from the parallel PCI bus to serial PCI Express, SATA, Ethernet, and USB, offering higher performance while maintaining backwards compatibility. Advantech's QA labs ensure that all boards are designed to meet the requirements of a wide array of industry standards including EN50155.



### 3U CPU Boards



#### MIC-3325

Intel® Atom™ Dual-core Intel® Atom™ D525/N455 Processor Blade  
2GB DDR3 memory, Extended I/O by extension modules (XTM), 2x DB9 COMs, 4HP vs 8HP

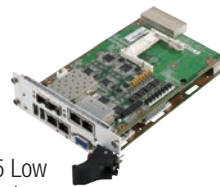

#### MIC-3326

Intel® Atom™ N455 Low Power Processor Blade  
2GB DDR3 memory, Extended I/O by extension modules (XTM), Up to 5x GbE, 4HP vs 8HP

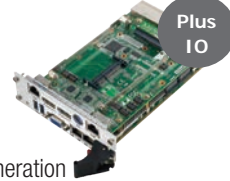

#### MIC-3328

CompactPCI PlusIO 3rd Generation Intel® Core™ Processor Blade  
Dual & Quad core, 8GB DDR3 w/ECC  
Wide range of XTMs for various I/O interfaces on 8HP. PCIe gen.3, SATA-III

### 3U I/O Cards



#### MIC-3954

3U CompactPCI Serial Peripheral Carrier  
Dual PCIe Mini card carrier for wireless modules or SATA carrier for storage



#### MIC-3955

4-port RS-232/422/485 Communication Card  
Speed up to 115200bps, 1KV isolation and 2KV surge protection

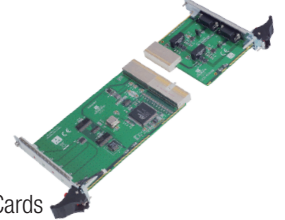

#### MIC-3680

2-port Isolated CAN Communication CPCI Cards  
Supports CAN2.0 A/B, Optical isolation up to 2,500 VDC, rear IO available



#### MIC-3716

16-ch Multi-function CompactPCI Card  
250 KS/s sampling rate, 16 bits resolution

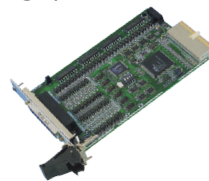

#### MIC-3756

64-ch Digital I/O CompactPCI Card  
32-ch input, 32-ch output, 2,500 VDC isolation protection



#### MIC-3758

128-ch Digital I/O CompactPCI Card  
64-ch input, 64-ch output, 2,500 VDC isolation protection



# 6U CompactPCI Portfolio

## Performance, Flexibility & Reliability



After initial mass deployment of products in the telecom industry at the turn of the millenium, Advantech has built on its experience gained from integrating mission critical CompactPCI systems for key telecom equipment manufacturers and has expanded into broader industries. With a growing number of deployments in process control, transportation, test & measurement, simulation and medical imaging amongst others, customers know they can rely on Advantech engineering for performance, flexibility and reliability.

### 6U CPU Boards



#### MIC-3395

2nd and 3rd Generation Intel® Core™ i3/i5/i7 Processor Blade with ECC support

Widely deployed and field-tested in applications around the globe, the MIC-3395 is a reliable SBC workhorse.



#### MIC-3396

4th Generation Intel® Core™ i3/i5/i7 Processor Blade with ECC support

The MIC-3396 boosts performance deploying the latest virtualization, techniques and CPU enhancements.



#### MIC-3397

Quad-core Intel® Xeon® E3 & dual-core Pentium® Processor Blade

Cost-optimize your application with the right CPU for your workload. The MIC-3397 is the most flexible SBC available.



#### MIC-3398

Intel® Atom SoC Processor Blade

The MIC-3398 is a low power blade developed specifically for industrial automation and SMT placement equipment



#### CPCI-8220

Freescale QorIQ P2040 Processor Board

The ultimate intelligent I/O card with a low power QorIQ and two PMC/XMC slots. Ideal for extended temps and low tdp needs.

### 6U RTM



#### RIO-3315

Rear Transition Module for MIC-3395

1x PS/2, 4x USBs, 2x RS232/422/485, 2x SATA, 2x GbE, 2x DVIs (1x digital & 1x digital/analog). 3 RTM versions provide a choice of storage & LAN options



#### RIO-3316

Rear Transition Module for MIC-3396

SATA III, USB 3.0, 2x GbE LAN & 2x PICMG 2.16



#### CPCI-8250

Rear Transition Module for CPCI-8220

4x GbE, choice of multiple RS232/422/485 serial interfaces managed by an onboard PLX OXPCIe958 QUART. 2x USB 2.0.

### XMC

#### MIC-3666

Dual 10 Gigabit Ethernet XMC

Intel® 82599ES 10 GbE Controller. PCIe x8 Gen. 2. Dual SFP+ ports



#### MIC-3667

Quad Gigabit Ethernet XMC

Intel® Ethernet Controller I350. PCIe x8 Gen.2. Quad RJ45 ports



# 3U & 6U CompactPCI Chassis

## Whatever the Application - Build Your Ideal System with Advantech CompactPCI



Plus IO

### MIC-3022 PLUS IO

4U CompactPCI Enclosure for 3U Cards

The MIC-3022 PlusIO supports CompactPCI PlusIO high-speed serial interconnects without interfering with legacy PCI signals. This allows interoperability with all PICMG CompactPCI 2.xx standards. The system slot incorporates a UHM connector, allowing connectivity to existing 32-bit boards as well as supporting differential signals up to 5 Gb/s per pair.



### MIC-3023

3U CompactPCI Fanless Enclosure for 3U Cards

The MIC-3023 hosts up to 2 systems each with six 3U cards on a 32bit, 33MHz or 66MHz PCI bus. The chassis can be powered by PICMG 2.11 power supplies for two individual systems. Fanless design makes MIC-3023 suitable for a wide range of applications and in particular transportation. Front swappable power supplies and add-in cards plus simplified fan replacement allows support for an MTTR of < 5 mins



### MIC-3042

4U 8-slot CompactPCI Enclosure for 6U Cards

The MIC-3042 integrates standard CompactPCI hot-swappable 250W AC power supplies and fans in a redundant 2+1 configuration. The system has 8 slots for CompactPCI boards and 6 slots for rear transition modules. Three versions are available for a wide choice of PICMG 2.5 and 2.16 topologies. Optional MIC-3927 Chassis Management.



### MIC-3043

4U 6-slot CompactPCI Enclosure with HDD Bay for 6U Cards

With the same power supply set up as the MIC-3042, the MIC-3043 comes with a 6-slot backplane and removable HDD bay for up to two 3.5" SATA or four 2.5" SATA/SAS drives. Equipped with hot swappable fans and built-in alarm module, a range of configurations are available with and without H.110 on the backplane.

### Rugged, highly configurable, long-life platform

The CPCI-8220 integrates the intelligence and low thermal design power of the Freescale QorIQ™ CPU with fast and reliable PMC-based I/O. Using standard and customized enclosures, scaling from one to six boards, OEMs can build robust and flexible platforms to meet the needs of almost any intelligent I/O solution.

- 6U chassis
- CPCI-8220 6U CompactPCI Freescale QorIQ P2040 Ruggedized Processor Board with custom I/O PMC



### Active standby and backup for non-stop operation

A dual processor configuration based on MIC-3325 Intel® Atom™ CPU boards provides full redundancy to help OEMs build applications that require maximum availability.

- MIC-3023 3U fanless chassis
- MIC-3325 CPU blade
- MIC-3955 4-port RS232/422/485 serial board



### Finely balance cost and performance

Advantech brings the latest Intel® processing technology to the CompactPCI form factor allowing customers to choose the right product from the range which matches their performance/cost sweet spots.

- MIC-3043 6U Chassis
- MIC-3398
- Customer designed I/O



### Scale up to meet performance needs

Advantech systems built around the PICMG 2.16 standard leverage the versatility of CompactPCI by clustering multiple SBCs over ethernet allowing OEMs to scale their applications from a single board system to a fully loaded one with 6 Intel® Core™ i7 blades and redundant switches.

- MIC-3042 6U chassis
- Fully loaded with MIC-3396 SBCs



### Customizable to enable upgrade continuity

Advantech CompactPCI boards can be customized to meet the same form, fit and function as your previous product, enabling non-disruptive upgrades when products reach end-of-life status or more processing power when your next generation solution needs it.

- 6U chassis
- MIC-3395
- Designed by the customer: Custom FPGA-based I/O for MRI control



# Building Your CompactPCI Applications To Meet Business Needs Now and into the Future

Many mission-critical applications benefit from the robustness and modularity offered by CompactPCI systems. For more than 10 years, Advantech has been developing standard CompactPCI equipment tailored to high-tech industries that require high levels of specialization leveraging COTS and customization with its C<sup>2</sup>OTS approach.



## Power & Energy

Power substations are not only critical because of their role in the electricity system but also because of their proximity to residential areas. That is why they are specially protected from both a physical and a functional perspective. CompactPCI-based industrial computer systems provide the data capture and storage facility required for substation monitoring. Looking forward to the deployment of smart grid technology, Advantech provides long-term technology support and timely new product introductions so that customers can choose when to upgrade their equipment based on strategy and market demands.



## Transportation

With over 11,000 km of tracks in service and 1.3 million daily ridership, the high-speed rail network in China is the largest and most heavily used in the world. BSafety being the major concern, not only train operation is monitored but also external factors that can have a fatal impact. Integrated as part of the disaster prevention system, Advantech CompactPCI platforms collect and analyze metrological, seismic and intrusion data allowing to foresee unwanted circumstances and react if necessary. Dual CompactPCI systems in active-backup configuration help the system integrator bring the reliable, non-stop operation required.

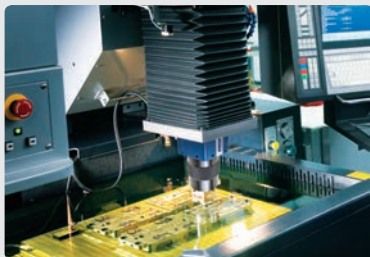

## Machine Automation

Surface-mount technology (SMT) is a method of producing electronic circuits in which components are mounted directly onto the surface of printed circuit boards. To satisfy high market demands driven by mobile devices high-speed SMT placement machines are required to precisely mount the smallest parts being used in mass production while being able to handle next generation components. Advantech CompactPCI platforms are used in this rugged environment to ensure reliability and uptime. Advantech's wide range of CompactPCI cards allow customers to perfectly balance cost and performance.



## Simulation

Full flight simulators replicate the complexity of an aircraft flight to train commercial pilots in compliance with aviation authorities requirements. The full reproduction of the flight deck simulates all flight instruments and the out-the-window (OTW) world which is projected by a cross-cockpit collimated display system that shows the same undistorted view to the two pilots sitting side by side. Advantech CompactPCI solutions combine the graphic performance that allows the real-time rendering along with the economy-of-scale that enables OEMs to build different cockpit configurations on a single platform not only for simulation training but also for classroom solutions.



## Medical

Manufacturers of MRI equipment are constantly focusing on offering higher performance in terms of improved image quality and consistency, faster imaging and processing. With high levels of reliability, modularity and upgradability, Advantech CompactPCI platforms have been chosen as processing element of MRI equipment design. Advantech's flexibility in modifying standard products is a decisive factor, as not all CompactPCI manufacturers' CPU blades offer the required feature set.

# CompactPCI System Integration — It's all about Teamwork

System integration at Advantech always begins by establishing a close relationship with our customer's team based on trust and mutual understanding, we create a highly collaborative environment which is essential for the success of complex system level programs to be deployed in mission critical applications.

Our CompactPCI Engineering Team brings together products engineered by our own hardware and software designers with tested ecosystem partner building blocks as well as proprietary customer hardware. We work closely with OEMs to design products using pre-qualified subsystems whenever possible to ensure baseline product interoperability and accelerate the integration process. We then define together the test procedures and harnesses which need to be put into place for the addition of proprietary I/O and non-qualified ecosystem hardware. Any specific needs are identified and statements of work are written to describe all developmental items required to guarantee full functionality and interoperability.

As technology evolves and markets move faster than ever, our engineering teams facilitate the design of new and innovative solutions more rapidly. We bring our knowledge and expertise to the table to help OEMs create the optimum solution, adapted where necessary to resolve their unique problems so they, in turn, can respond more effectively to special customer demands. By reducing project risk and complexity at the system level, our customers get to market faster and more affordably with tested and dependable solutions.



## Integrating CompactPCI into Rugged Environments

When you need a reliable product to meet your ruggedized needs, tap into Advantech's experience in designing and qualifying CompactPCI products for harsh environments. Advantech's capabilities span from conformal coating, extended temperature component selection and screening to fully ruggedized conduction cooled boards. Our MIC-3395MIL typifies our expertise. It is a ruggedized 6U CompactPCI board based on the Intel® Core™ i7-3500 mobile processor series. It combines ultra-low voltage multicore processors with very low power dissipation and a highly conductive aluminum heat sink to eliminate the need for on-board forced ventilation. Ruggedized requirements are satisfied by its conduction cooled design and allow it to meet extended operating temperatures of -40°C to 70°C necessary for use in military and defense, aerospace and transportation applications among others.

The shock and vibration resistance of the board is increased by the use of wedge locks fitted to a single-piece CNC-milled aluminum alloy heat sink plate which also provides a low impedance thermal path between the board and the chassis. Conformal coating can also be applied to act as protection against moisture, dust, and chemicals that could result in damage or failure if non-protected.

For railway applications that need to comply to EN50155 standards, Advantech makes use of its advanced DQA facilities in order to test and qualify CompactPCI products for extended -40°C to +85°C operating temperature ranges with specific BIOS implementations used for reliable cold start.



# Advantech DQA - Design Quality Assurance

One of the reasons that industrial OEMs choose the CompactPCI architecture is the ecosystem's dedication to delivering interoperability. At Advantech NCG, testing goes far beyond functional validation and interoperability. Signal integrity, power integrity and reliability are key items to guarantee our designs conform to the PICMG and specific chipsets' specifications.

Design engineers typically apply Intel® Voltage Transient Tool (VTT) and other test gear to validate their designs. Advantech NCG goes one step further and employs a 40-strong dedicated DQA team of engineers each of whom bring added expertise in their particular domain in order to yield the highest possible product quality. We test all our designs to their limits and beyond, checking thermal profiles, signal integrity, shock and vibration. Our HALT (Highly Accelerated Life Test) capability allows us to stress equipment so customers rest assured that the equipment they deploy has been carefully designed using the most stringent processes.

DQA is much more than just meeting the limits. At Advantech, DQA is about maximizing design margin.

## Advanced Testing Tools and Environment

Much of Advantech's commitment to DQA is manifest in our investment in testing tools, equipment and facilities. Some of the advanced testing gear and procedures in our DQA Lab include:

### Walk-in Thermal Chamber

In addition to our standard thermal chambers we have installed an Espec thermal walk-in chamber which allows us to host a rack full of systems for temperature and humidity cycling tests. For system-level testing we have enhanced the power feeds to the devices under test in the chamber from 6kW to 10kW. An IR camera/scanner and thermocouples/datalogger allow us to perform thermal profiling of a board.

### High Speed Signal Measurement (HSSM) Chamber

The amount of stray noise in a typical open environment which constitutes today's wireless world makes precise high speed signal measurements impossible. At Advantech, we perform high speed measurements from within large EMI chambers to shield our high speed scopes and network analyzers from external noise. It's only by investing in these higher levels of shielding that we are sure to obtain reliable and systematic test results which can ensure adequate design quality to our customers. Housed within the HSSM chamber we employ tools such as Agilent N525A 10MHz to 50GHz network analyzers for insertion loss, return loss and crosstalk testing, Agilent 32GHz scopes to measure signal quality by evaluating criteria such as eye diagrams and jitter.

### Network Test

Spirent SmartBits, Test Center and IXIA Optixia test equipment are all employed to test, simulate, analyze, troubleshoot, develop, and in some cases certify each of the networking interfaces on our products. By employing industry leading traffic generation and analysis tools we are able to ensure that all designs are rigorously tested using typical network traces and loads.

### Highly Accelerated Life Test (HALT)

The lab's high-end HALT chamber allows us to stress equipment, including individual boards or fully loaded systems until they break, with temperatures between -100°C and +200°C, with temperature gradients as high as 60°C/minute and up to 50G shock or vibration. The HALT chamber is used in order to quickly determine the lowest and highest operating ambient conditions as well as the weakest mechanical design of the board or system.



# Global Services

World class OEMs need a partner they can rely on to deploy Mission Critical Equipment in the harshest environments on the planet.

## Manufacturing Capabilities

Our world-class manufacturing centers in Taiwan and China both maintain precise quality control, and offer a full range of cost-effective, state-of-the-art production capabilities. To maximize the efficiency of operational procedures, we have implemented a cluster manufacturing system within our segmented manufacturing service units. This unique approach enables a direct, simplified, and highly streamlined design-to-manufacturing process. Our manufacturing centers utilize a customer-driven Enterprise Resource Planning (ERP) system to achieve high flexibility and just-in-time response. We pride ourselves on our:

- In-house board, chassis, and system production capabilities
- Dual world-class manufacturing centers which minimize business risks
- Advanced production capabilities and customizable processes
- Rigid quality assurance system
- Complete ISO standard coverage

## We Build It Exactly as You Imagine It

Advantech provides full customization and branding services to integrate our innovative platforms with existing product lines and give them customers' look and feel. With our Configure-To-Order-Services (CTOS) we provide cost efficient services to build different system SKUs in our logistic centers around the world. Through these services we bring our clients the benefits of greater flexibility, lower inventory, shorter lead times and global reach with local touch at work.

## International Quality Standards

The Group Quality system is audited and compliant with ISO 9001. The Quality system covers all aspects of product design, component selection, design verification, manufacturing, quality control and customer satisfaction. From the board of directors down, each member takes pride in providing our customers with the highest level of quality in products and services. We also hold global certifications of ISO 13485, TL 9000, ISO 14001, OHSAS 18001 and IECQ QC 080000.

## Global Logistics Services

With strong integrated ERP and SAP supply chain solutions, our worldwide logistics network offers a wide range of flexibilities to bring out different delivery models including local and global solutions that meet your unique needs and budget requirements. Advantech's Logistics Service gives you the flexibility to simplify your logistical networks, bring your products to market on time, and enjoy a timely return on your investment.

- Optimized and flexible shipping solutions
- Integrated ERP and SAP supply chain solution with global distribution network
- Centralized plants with local delivery

## Customer Support Services

Our global presence provides localizable, customizable, and reliable customer support services. We can create an optimized maintenance and support plan, leveraging the full power of our service portfolio to help reduce costs and proactively mitigate business risks to best meet your needs. In addition to our complete technical and repair support, we provide a variety of customizable after-sales services, including extended warranty, advance replacement, upgrade, fast repair, etc. With our knowledgeable local support groups, we enable a consistent support experience around the world and help keep your investment at peak performance and within your budget. Our local support centers are dedicated to supporting your high-value ATCA systems deployed in business-critical installations across the world.

- 24/7 technical support: hotline AE & online chat support
- Global deployment with local full-line repair capability
- Easy-to-use web-based repair and tracking system
- Various other value-added, after-sales support services



# Ensure Your Long Term Success with Advantech CompactPCI

- Long-term Support
- Leading Edge Technology
- Field Proven Quality
- Time-to-market Efficiencies



▪ Military & Aerospace



▪ Power & Energy



▪ Test & Instrument



▪ Transportation



▪ Telecom

## Tick all the boxes on your next generation CompactPCI design requirements list:

### MIC-3396 with 4th generation Intel® Core™ processor (formerly codenamed Haswell)

- ✓ Intel® 8 series chipset
- ✓ Based on Intel® 22 nm 3D tri-gate transistor manufacturing technology
- ✓ Configurable TDP technology reduces package power consumption
- ✓ Enables support for previous ULV/LV platforms (17W/25W)
- ✓ Triple display support Designed for maximum reliability
- ✓ 5 LAN ports using Intel® i210 NICs: 2 /1 front, 1/ 2 rear, 2 PICMG2.16
- ✓ Faster I/O: PCIe gen.3 , USB3.0, SATA-III
- ✓ Optional BMC for advanced management
- ✓ Redundant BIOS support for fail safe upgrades
- ✓ ECC memory down on board
- ✓ XMC slot for I/O Expansion
- ✓ Soldered flash for data logging
- ✓ AMT7.0 including KVM red.

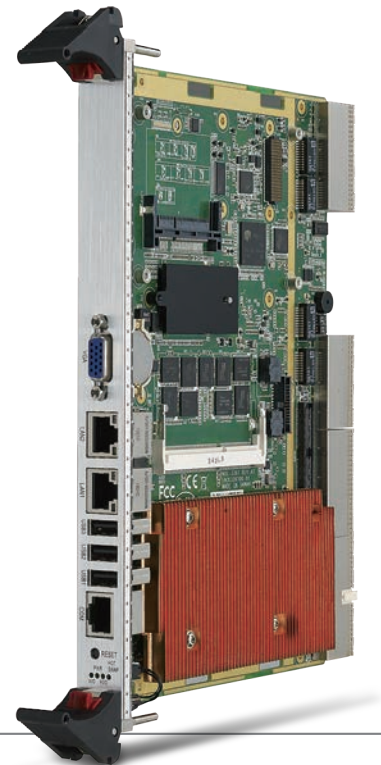

Take a closer look at how Advantech CompactPCI can meet your business needs now and into the future.

[www.advantech.com/compactpci](http://www.advantech.com/compactpci)

# Global Access, Local Support



## Regional Service & Customization Centers

### China

Kunshan  
86-512-5777-5666

### Taiwan

Taipei  
886-2-2792-7818

### Netherlands

Eindhoven  
31-40-267-7000

### Poland

Warsaw  
48-22-33-23-740 / 741

### USA

Milpitas, CA  
1-408-519-3898

## Worldwide Offices

### Greater China

**China**  
 800-810-0345  
 Beijing 86-10-6298-4346  
 Shanghai 86-21-3632-1616  
 Shenzhen 86-755-8212-4222  
 Chengdu 86-28-8545-0198  
 Hong Kong 852-2720-5118

**Taiwan**  
 0800-777-111  
 Rueiguang 886-2-2792-7818  
 Yang Guang 886-2-2792-7818  
 Xindian 886-2-2218-4567  
 Taichung 886-4-2378-6250  
 Kaohsiung 886-7-229-3600

### Asia Pacific

**Japan**  
 0800-500-1055  
 Tokyo 81-3-6802-1021  
 Osaka 81-6-6267-1887

**Korea**  
 080-363-9494  
 Seoul 82-2-3663-9494

**Singapore**  
 Singapore 65-6442-1000

**Malaysia**  
 1800-88-1809  
 Kuala Lumpur 60-3-7724-3555  
 Penang 60-4-397-3788  
 60-4-397-4188

**Indonesia**  
 Jakarta 62-21-769-0525

**Thailand**  
 Bangkok 66-2-248-3140

**India**  
 1800-425-5071  
 Bangalore 91-80-25450206

**Australia**  
 1300-308-531  
 Melbourne 61-3-9797-0100  
 Sydney 61-2-9476-9300

### Europe

**Europe** 00800-2426-8080

**Germany**  
 München 49-89-12599-0  
 Hilden 49-2103-97-885-0

**France**  
 Paris 33-1-4119-4666

**Italy**  
 Milano 39-02-9544-961

**Benelux & Nordics**  
 Breda 31-76-5233-100

**UK**  
 Reading 44-0118-929-4540

**Poland**  
 Warsaw 48-22-33-23-740/741

**Russia**  
 Moscow 8-800-555-01-50  
 7-495-232-1692

### Americas

**North America**  
 1-800-866-6008  
 1-888-576-9668  
 Cincinnati 1-513-742-8895  
 Milpitas 1-408-519-3898  
 Irvine 1-949-420-2500

**South America**  
 Mexico 52-55-6275-2777

**Brazil**  
 São Paulo 0800-770-5355  
 55-11-5592-5355

# ADVANTECH

Enabling an Intelligent Planet

[www.advantech.com](http://www.advantech.com)

Please verify specifications before ordering. This guide is intended for reference purposes only. All product specifications are subject to change without notice. No part of this publication may be reproduced in any form or by any means, electronic, photocopying, recording or otherwise, without prior written permission of the publisher. All brand and product names are trademarks or registered trademarks of their respective companies. © Advantech Co., Ltd. 2015



860000187