



User Manual

AIMB-279

**12/13th Gen Intel® Core™
Processor (Alder Lake / Raptor
Lake), Mini-ITX with Q670E/
H610E, PCIe x16 Gen4, 2.5GbE**

ADVANTECH

Enabling an Intelligent Planet

Copyright

The documentation and the software included with this product are copyrighted 2024 by Advantech Co., Ltd. All rights are reserved. Advantech Co., Ltd. reserves the right to make improvements in the products described in this manual at any time without notice. No part of this manual may be reproduced, copied, translated, or transmitted in any form or by any means without the prior written permission of Advantech Co., Ltd. The information provided in this manual is intended to be accurate and reliable. However, Advantech Co., Ltd. assumes no responsibility for its use, nor for any infringements of the rights of third parties that may result from its use.

Acknowledgements

IBM and PC are trademarks of International Business Machines Corporation.

Intel® Core™ i9/i7/i5/i3, Pentium®, and Celeron® are trademarks of Intel Corporation.

All other product names or trademarks are properties of their respective owners.

Product Warranty (2 Years)

Advantech warrants the original purchaser that each of its products will be free from defects in materials and workmanship for two years from the date of purchase.

This warranty does not apply to any products that have been repaired or altered by persons other than repair personnel authorized by Advantech, or products that have been subject to misuse, abuse, accident, or improper installation. Advantech assumes no liability under the terms of this warranty as a consequence of such events.

Because of Advantech's high quality-control standards and rigorous testing, most customers never need to use our repair service. If an Advantech product is defective, it will be repaired or replaced free of charge during the warranty period. For out-of-warranty repairs, customers will be billed according to the cost of replacement materials, service time, and freight. Please consult your dealer for more details.

If you believe your product is defective, follow the steps outlined below.

1. Collect all the information about the problem encountered. (For example, CPU speed, Advantech products used, other hardware and software used, etc.) Note anything abnormal and list any onscreen messages displayed when the problem occurs.
2. Call your dealer and describe the problem. Please have your manual, product, and any helpful information readily available.
3. If your product is diagnosed as defective, obtain a return merchandise authorization (RMA) number from your dealer. This allows us to process your return more quickly.
4. Carefully pack the defective product, a completed Repair and Replacement Order Card, and a proof of purchase date (such as a photocopy of your sales receipt) into a shippable container. Products returned without a proof of purchase date are not eligible for warranty service.
5. Write the RMA number clearly on the outside of the package and ship the package prepaid to your dealer.

Part No. 2006027900

Printed in China

Edition 1

January 2024

Declaration of Conformity

FCC Class B

This equipment has been tested and found to comply with the limits for a Class B digital device, pursuant to part 15 of the FCC Rules. These limits are designed to provide reasonable protection against harmful interference in a residential installation. This equipment generates, uses, and can radiate radio frequency energy and, if not installed and used in accordance with the instructions, may cause harmful interference to radio communications. However, there is no guarantee that interference will not occur in a particular installation. If this equipment does cause harmful interference to radio or television reception, which can be determined by turning the equipment off and on, the user is encouraged to try to correct the interference by one or more of the following measures:

- Reorient or relocate the receiving antenna.
- Increase the separation between the equipment and receiver.
- Connect the equipment into an outlet on a circuit different from that to which the receiver is connected.
- Consult the dealer or an experienced radio/TV technician for assistance.

CPU Compatibility

Processor Number	Max_TDP	Code Name	Cores/Threads	S-Spec	Lithography
i9-13900TE	35W	Raptor Lake	8P+16E/32T	SRMG1	Intel 7
i9-13900E	65W	Raptor Lake	8P+16E/32T	SRMG2	Intel 7
i9-13900	65W	Raptor Lake	8P+16E/32T	SRMB6	Intel 7
i7-13700TE	35W	Raptor Lake	8P+4E/24T	SRMG4	Intel 7
i7-13700E	65W	Raptor Lake	8P+8E/24T	SRMG3	Intel 7
i7-13700	65W	Raptor Lake	8P+4E/24T	SRMBA	Intel 7
i5-13500TE	35W	Raptor Lake	6P+8E/20T	SRMFZ	Intel 7
i5-13500E	65W	Raptor Lake	6P+8E/20T	SRMFW	Intel 7
i5-13500	65W	Raptor Lake	6P+8E/20T	SRMBM	Intel 7
i5-13400	65W	Raptor Lake	6P+4E/16T	SRMBP	Intel 7
i3-13100TE	35W	Raptor Lake	4P+0E/8T	SRMFT	Intel 7
i3-13100E	65W	Raptor Lake	4P+0E/8T	SRMFR	Intel 7
i3-13100	65W	Raptor Lake	4P+0E/8T	SRMFR	Intel 7
i9-12900TE	35W	Alder Lake	8P+8E/24T	SRL6C	Intel 7
i9-12900E	65W	Alder Lake	8P+8E/24T	SRL6B	Intel 7
i9-12900	65W	Alder Lake	8P+8E/24T	SRL4K	Intel 7
i7-12700TE	35W	Alder Lake	8P+4E/20T	SRL6E	Intel 7
i7-12700E	65W	Alder Lake	8P+4E/20T	SRL6D	Intel 7
i7-12700	65W	Alder Lake	8P+4E/20T	SRL4Q	Intel 7
i5-12500TE	35W	Alder Lake	6P/12T	SRL6V	Intel 7
i5-12500E	65W	Alder Lake	6P/12T	SRL6W	Intel 7
i5-12500	65W	Alder Lake	6P/12T	SRL5V	Intel 7
i5-12400	65W	Alder Lake	6P/12T	SRL5Y	Intel 7
i3-12100TE	35W	Alder Lake	4P/8T	SRL6T	Intel 7
i3-12100E	60W	Alder Lake	4P/8T	SRL6U	Intel 7
i3-12100	60W	Alder Lake	4P/8T	SRL62	Intel 7
G7400TE	35W	Alder Lake	2P/4T	SRL6S	Intel 7
G7400E	46W	Alder Lake	2P/4T	SRL6R	Intel 7
G6900TE	35W	Alder Lake	2P/2T	SRL6P	Intel 7
G6900E	46W	Alder Lake	2P/2T	SRL6Q	Intel 7

Memory Compatibility

Category	Speed	Capacity	Vendor	Chip_PN	ADVANTECH P/N	ECC
DDR4	3200	16GB	Advantech	SEC001 K4A8G08 5WCBCWE	SQR-SD4N16G3K2SNCB	N
DDR4	2666	16GB	Advantech	SEC 928 K4A8G08 5WC BCTD	AQD-SD4U16N26-SE	N
DDR4	3200	32GB	Advantech	SEC146 K4AAG08 5WABCWE	SQR-SD4N32G3K2SNAB	N
DDR4	2666	8GB	Advantech	SEC 837 K4A8G08 5WC BCTD	SQR-SD4N8G2K6SNBCB	N
DDR4	3200	4GB	Advantech	SEC225 K4A8G16 5WCBCWE	SQR-SD4N4G3K2SNPCB	N
DDR4	2400	4GB	Advantech	SEC007 K4A4G08 5WFBCTD	SQR-SD4N4G2K4SNEFB	N
DDR4	3200	32GB	Advantech	SEC019 K4AAG08 5WABCWE	AQD-SD4U32GN32-SB	N
DDR4	2133	8GB	Advantech	SEC 552 BCPB K4A4G085WD	AQD-SD4U8GN21-SG	N
DDR4	3200	8GB	Advantech	SEC001 K4A8G08 5WCBCWE	AQD-SD4U8GN32-SE	N

M.2 SSD Compatibility

Dimension	Interface	Bandwidth Performance	Category	Vendor	Model	ADVANTECH P/N	Result
2242	M.2 M-Key	PCIe v3.1	NVMe PCIe SSD	Advantech	SQF-C4MV4-2TDEDC	SQF-C4MV4-2TDEDC	PASS
2242	M.2 B+M Key	SATA3	SSD	Advantech	SQF-SM4Z2-128GCSBE	SQF-SM4Z2-128GCSBE	PASS

M.2 Wi-Fi Compatibility

Dimension	Interface	Bandwidth Performance	Category	Vendor	Model	ADVANTECH P/N	Result
2230	M.2 A+E Key	PCI-E / USB	Wireless LAN + Bluetooth	Advantech	EWM-W192M201E	EWM-W192M201E	PASS
2230	M.2 A+E Key	PCI-E / USB	Wireless LAN + Bluetooth	Advantech	EWM-W179M201E	EWM-W179M201E	PASS
2230	M.2 A+E Key	PCI-E / USB	Wireless LAN + Bluetooth	Advantech	EWM-W165M203E	EWM-W165M203E	PASS
2230	M.2 A+E Key	PCI-E / USB	Wireless LAN + Bluetooth	Advantech	EWM-W159M201E	EWM-W159M201E	PASS
2230	M.2 A+E Key	PCIe v3.1	NVMe PCIe SSD	Advantech	SQF-CM3V1-512G-EDC	SQF-CM3V1-512G-EDC	PASS

Initial Inspection

Before you begin installing your motherboard, please make sure that the following materials have been shipped:

- 1 x AIMB-279 Intel® Core™ i9/i7/i5/i3 LGA1700 Mini-ITX motherboard
- 1 x SATA HDD cable
- 1 x SATA power cable
- 1-to-1 serial port cables, 50 cm
- 1 x I/O port bracket
- 1 x Startup Manual
- 1 x Warranty Card

If any of these items are missing or damaged, contact your distributor or sales representative immediately. We have carefully inspected the AIMB-279 mechanically and electrically before shipment. It should be free of marks and scratches and in perfect working order upon receipt. As you unpack the AIMB-279, check it for signs of shipping damage. (For example, damaged box, scratches, dents, etc.) If it is damaged or it fails to meet the specifications, notify our service department or your local sales representative immediately. Also notify the carrier. Retain the shipping carton and packing material for inspection by the carrier. After inspection, we will make arrangements to repair or replace the unit.

Contents

Chapter 1 General Information1

1.1	Introduction	2
1.2	Features	2
1.3	Specifications	2
1.3.1	System	2
1.3.2	Memory	2
1.3.3	Input/Output	2
1.3.4	Graphics	3
1.3.5	Ethernet LAN	3
1.3.6	Industrial Features	3
1.3.7	Mechanical and Environmental Specifications	3
1.4	Jumpers and Connectors	4
	Table 1.1: Connector and Header List	4
1.5	Board Layout: Jumper and Connector Locations	5
	Figure 1.1 Jumper and Connector Locations (Top Side)	5
	Figure 1.2 Jumper and Connector Locations (Bottom Side)	6
1.6	AIMB-279 Board Diagram	7
	Figure 1.3 AIMB-279 Block Diagram	7
1.7	Safety Precautions	7
1.8	Jumper Settings	8
1.8.1	How to Set Jumpers	8
1.8.2	CMOS Clear (JCMOS1)	8
	Table 1.2: JCMOS1	8
1.8.3	ATX/AT Mode Selection (PSON1)	8
	Table 1.3: ATX/AT Mode Selection (PSON1)	8
1.8.4	eDP/LVDS Panel Voltage Selection (JEDP1_LVDS1)	9
	Table 1.4: eDP/LVDS Panel Voltage Selection (JEDP1_LVDS1)	9
1.8.5	PCI Express x16 Bifurcation (SW1)	9
	Table 1.5: PCI Express x16 Bifurcation (SW1)	9
1.8.6	COM1_RI# Pin RI# / 5V / 12V Selection (JSETCOM1_V1)	9
	Table 1.6: COM1_RI# Pin RI# / 5V / 12V Selection (JSET-COM1_V1)	9
1.9	System Memory	10
1.10	Memory Installation Procedures	10
1.11	Cache Memory	10
1.12	Processor Installation	10

Chapter 2 Connecting Peripherals11

2.1	Introduction	12
2.2	DC-In Power Connector (DCIN1)	12
	Table 2.1: DC-In Power Connector (DCIN1)	12
2.3	RJ-45 + USB 3.2 Stack Connector (LAN1_USB12)	12
	Table 2.2: RJ-45 + USB 3.2 Stack Connector (LAN1_USB12)	12
2.4	RJ-45 Connector (LAN2)	13
	Table 2.3: RJ-45 Connector (LAN2)	13
2.5	Universal Serial Bus 3.2 (USB34)	13
	Table 2.4: Universal Serial Bus 3.2 (USB34)	13
2.6	DisplayPort Connector (DP2)	14
	Table 2.5: DisplayPort Connector (DP2)	14
2.7	DisplayPort Dual Port Stack-Up Connector (DP1+HDMI1)	14
	Table 2.6: DisplayPort Dual Port Stack-Up Connector (DP1+HDMI1)	15
2.8	HD Audio Interface (Analog) (AUDIO1)	15

	Table 2.7: HD Audio Interface (Analog) (AUDIO1).....	15
2.9	Audio Amplifier Output Pin Header (AMP1).....	15
	Table 2.8: Audio Amplifier Output Pin Header (AMP1)	16
2.10	PCI Express x16 Slot (PCIEX16_1).....	16
	Table 2.9: PCI Express x16 Slot (PCIEX16_1)	16
2.11	IMVP9.1 Programming Header (VR_PMB1).....	18
	Table 2.10: IMVP9.1 Programming Header (JSMB1)	18
2.12	System Fan #1 Connector (SYSFAN1)	18
	Table 2.11: System Fan #1 Connector (SYSFAN1).....	18
2.13	CPU FAN Connector (CPUFAN1)	18
	Table 2.12: CPU FAN Connector (CPUFAN1).....	18
2.14	EDP Connector / LVDS Connector (EDP1_LVDS1).....	19
	Table 2.13: LVDS Connector (LVDS1).....	19
	Table 2.14: EDP Connector (EDP1).....	19
2.15	LVDS VESA, JEIDA Format Selection Pin Header (JLVDS_VCON1)....	20
	Table 2.15: LVDS VESA, JEIDA Format Selection Pin Header (JL- VDS_VCON1)	20
2.16	EDP Panel / LVDS Panel Voltage Selection (JEDP1_LVDS1).....	20
	Table 2.16: EDP Panel / LVDS Panel Voltage Selection (JEDP1_L- VDS1).....	20
2.17	EDP / LVDS Backlight Inverter Power Connector (INV1)	20
	Table 2.17: EDP / LVDS Backlight Inverter Power Connector (INV1).....	21
2.18	AT / ATX Mode Selection (PSON1).....	21
	Table 2.18: AT / ATX Mode Selection (PSON1)	21
2.19	8-Bit General Purpose I/O Pin Header (GPIO1)	21
	Table 2.19: 8-Bit General Purpose I/O Pin Header (GPIO1).....	21
2.20	ESPI Port 80 Connector (ESPI_P80).....	21
	Table 2.20: ESPI Port 80 Connector (ESPI1)	22
2.21	COM1 Connector (COM1)	22
	Table 2.21: COM1 Connector (COM1).....	22
2.22	SATA Power (SATA_PWR2)	22
	Table 2.22: SATA Power (SATA_PWR2).....	22
2.23	COM2 Connector (COM2)	23
	Table 2.23: COM2 Connector (COM2).....	23
2.24	SATA Power (SATA_PWR1)	23
	Table 2.24: SATA Power (SATA_PWR1).....	23
2.25	PWRBTN#/ RESET#/HDD LED/SMBUS (JFP1)	23
	Table 2.25: PWRBTN#/ RESET#/HDD LED/SMBUS (JFP1)	23
2.26	Power LED Pin Header (JFP2).....	24
	Table 2.26: Power LED Pin Header (JFP2)	24
2.27	Serial ATA Interface Connector (SATA2)	24
	Table 2.27: Serial ATA Interface Connector (SATA2).....	24
2.28	Serial ATA Interface Connector (SATA1)	24
	Table 2.28: Serial ATA Interface Connector (SATA1).....	24
2.29	USB 2.0 Front Panel Header (USB56)	25
	Table 2.29: USB 2.0 Front Panel Header (USB56).....	25
2.30	CMOS Mode Selection (JCMOS1)	25
	Table 2.30: CMOS Mode Selection (JCMOS1).....	25
2.31	Flash Descriptor Security Override Pin Header (JME1)	25
	Table 2.31: Flash Descriptor Security Override Pin Header (ME1). 25	
2.32	M.2 M-Key Connector (M2_M1).....	26
	Table 2.32: M.2 M-Key Connector (M2M1)	26
2.33	SPI BIOS Flash Pin Header (SPI_CN1)	27
	Table 2.33: SPI BIOS Flash Pin Header (SPI_CN1).....	27
2.34	M.2 E-Key Connector (M2_E1).....	27
	Table 2.34: M.2 E-Key Connector (M2E1)	27
2.35	CMOS Battery Connector (BAT1).....	28
	Table 2.35: CMOS Battery Connector (BAT1)	28

2.36	Case Open connector (JCASE1)	29
	Table 2.36: Case Open Connector (JCASE1).....	29
2.37	COM1 RI# Selection Pin Header (JSETCOM1_V1)	29
	Table 2.37: COM1 RI# Selection Pin Header (JSETCOM1_V1).....	29
2.38	PCI Express x16 Bifurcation (SW_PEGSEL1).....	29
	Table 2.38: PCI Express x16 Bifurcation (SW_PEGSEL1)	29

Chapter 3 BIOS Operation31

3.1	Introduction	32
3.2	BIOS Setup	32
3.2.1	Main Menu	33
	Figure 3.1	33
3.2.2	Advanced BIOS Features	34
	Figure 3.2	34
	Figure 3.3	35
	Figure 3.4	35
	Figure 3.5	36
	Figure 3.6	36
	Figure 3.7	37
	Figure 3.8	37
	Figure 3.9	38
	Figure 3.10.....	38
	Figure 3.11.....	39
	Figure 3.12.....	39
	Figure 3.13.....	40
	Figure 3.14.....	40
	Figure 3.15.....	41
	Figure 3.16.....	42
	Figure 3.17.....	42
	Figure 3.18.....	43
	Figure 3.19.....	43
	Figure 3.20.....	44
	Figure 3.21.....	45
	Figure 3.22.....	46
	Figure 3.23.....	46
	Figure 3.24.....	47
	Figure 3.25.....	47
	Figure 3.26.....	48
	Figure 3.27.....	48
	Figure 3.28.....	49
	Figure 3.29.....	50
	Figure 3.30	50
	Figure 3.31.....	51
	Figure 3.32.....	51
	Figure 3.33.....	52
	Figure 3.34.....	52
	Figure 3.35.....	53
	Figure 3.36.....	53
	Figure 3.37.....	54
	Figure 3.38.....	54
	Figure 3.39.....	55
	Figure 3.40.....	55
	Figure 3.41.....	56
	Figure 3.42.....	56
	Figure 3.43.....	57
	Figure 3.44.....	57
	Figure 3.45.....	58
	Figure 3.46.....	58

	Figure 3.47	59
	Figure 3.48	59
	Figure 3.49	60
	Figure 3.50	60
	Figure 3.51	61
	Figure 3.52	61
	Figure 3.53	62
	Figure 3.54	62
	Figure 3.55	63
3.2.3	Chipset Configuration Settings	64
	Figure 3.56	64
	Figure 3.57	65
	Figure 3.58	65
	Figure 3.59	66
	Figure 3.60	66
	Figure 3.61	67
	Figure 3.62	67
	Figure 3.63	68
	Figure 3.64	68
	Figure 3.65	69
	Figure 3.66	69
	Figure 3.67	70
	Figure 3.68	70
	Figure 3.69	71
	Figure 3.70	71
	Figure 3.71	72
	Figure 3.72	73
	Figure 3.73	73
	Figure 3.74	74
	Figure 3.75	74
	Figure 3.76	75
	Figure 3.77	75
	Figure 3.78	76
	Figure 3.79	76
	Figure 3.80	77
	Figure 3.81	77
	Figure 3.82	78
3.2.4	Security	78
	Figure 3.83	78
	Figure 3.84	79
3.2.5	Boot Setting	80
	Figure 3.85	80
3.2.6	Save & Exit Configuration	81
	Figure 3.86	81

Chapter 4 Software Introduction & Services ... 83

4.1	Introduction	84
4.2	Value-Added Software Services	84
4.2.1	Software API	84

Chapter 5 Chipset Software Installation Utility 87

5.1	Before you Begin	88
5.2	Introduction	88

Chapter 6 Display Driver Setup 89

6.1	Introduction	90
6.2	Windows 10 Display Driver Installation	90

Chapter 7 LAN Configuration.....91

7.1	Introduction	92
7.2	Features	92
7.3	Installation	92
7.4	Windows® 10 Driver Setup (Intel® i219LM & Intel® i226).....	92

Chapter 1

General Information

1.1 Introduction

AIMB-279 is designed with the Intel® Q670E/H610E PCH for industrial applications that require both performance computing and enhanced power management capabilities. The motherboard supports desktop Intel® Core™ i9/i7/i5/i3/Pentium®/Celeron® processors, up to 36 MB SmartCache, and 2 x DDR4 3200MHz SODIMM, up to 64GB. It also provides abundant I/O connectivity: 2 x serial ports, 4 x USB 3.2 Gen2, 1 x GbE LAN, 1 x 2.5 GbE LAN, 2 x SATA III, 1 x NGFF (M.2 E-Key), 1 x NGFF (M.2 M-Key) connector, and 1 x PCIe x16 slot.

1.2 Features

- **I/O connectivity:** 2 x serial ports, 2 x USB 3.2 Gen2, 2 x USB 3.2 Gen1, 2 x SATA III, 1 M.2 M-Key & 1 M.2 E-Key, 1 GbE LAN, 1 x 2.5GbE LAN, 1 x PCIe x16 Gen4
- **Standard Mini-ITX form factor with industrial features:** AIMB-279 is a full-featured Mini-ITX motherboard with balanced expandability and performance.
- **Wide selection of storage devices:** SATA HDD, M.2 M-Key. Customers benefit from the flexibility of using the most suitable storage device for the capacity they need.
- **Optimized integrated graphics solution:** With Intel® Graphics flexibility, it supports versatile display options and a 32-/64-bit 3D graphics engine.

1.3 Specifications

1.3.1 System

- **CPU:** Desktop Intel® Core™ i9/i7/i5/i3/Pentium®/Celeron® (LGA1700) processor
- **BIOS:** AMI EFI 256 Mbit SPI BIOS
- **System chipset:** Intel® Q670E/H610E
- **SATA hard disk drive interface:**
 - 2 x onboard SATA connectors with data transmission rates up to 600MB/s
 - One M.2 M-Key to support PCIe/NVMe x4 M.2 2242

1.3.2 Memory

- **RAM:** 2 x 260-pin SODIMM socket support for dual channel DDR4 3200MHz SDRAM, up to 64GB Max

1.3.3 Input/Output

- **Serial ports:** Two serial ports; COM1 supports RS-232, COM2 supports RS-232/422/485
- **USB ports:** Supports 4 x USB 3.2 with transmission rates of up to 10 Gbps.
- **GPIO connector:** 8-bit general purpose Input/Output

1.3.4 Graphics

- **Controller:** Intel® HD graphics
- **eDP:** Supports max. resolution 4096 x 2160 @ 60Hz, colay LVDS
- **DisplayPort 1.4:** Supports max. resolution 4096 x 2304 @ 60 Hz
- **HDMI 2.0a:** Supports max. resolution 4096 x 2160 @ 60 Hz
- **LVDS:** Supports single/dual channel 18-/24-bit with maximum resolution up to 1920 x 1200 @ 60 Hz (LVDS colay with eDP)

1.3.5 Ethernet LAN

- Supports dual 10/100/2500 Mbps Ethernet port (s) via PCI Express x1 bus which provides 500 MB/s data transmission rates.
- **Controller:**
 - GbE LAN1: Intel® i219LM
 - GbE LAN2: Intel® i226V

1.3.6 Industrial Features

- **Watchdog timer:** Can generate a system reset. The watchdog timer is programmable, with each unit equal to one second or one minute (255 levels).

1.3.7 Mechanical and Environmental Specifications

- **Operating temperature:** 0 ~ 60°C (32 ~ 140°F, depending on CPU)
- **Storage temperature:** -40 ~ 85°C (-40 ~ 185°F)
- **Humidity:** 5 ~ 95% non-condensing.
- **Power supply voltage:** +3.3V, +5V, +12V, -12V, +5VSB
- **Power consumption:** Intel® Core™ i9-13900E 5.2GHz, 2pcs 32GB DDR4 3200MHz, 24V @4.45A with 24V DC Input adapter
- **Board size:** 170 x 170 mm (6.69" x 6.69")
- **Board weight:** 0.365 kg

1.4 Jumpers and Connectors

Connectors on the AIMB-279 motherboard link it to devices such as hard disk drives and a keyboard. In addition, the board has a number of jumpers used to configure the system for your application.

The tables below list the function of each of the board jumpers and connectors. Later sections in this chapter give instructions on setting jumpers. Chapter 2 gives instructions for connecting external devices to your motherboard.

Table 1.1: Connector and Header List

Item	Description	Part Reference
1	DC IN CONNECTOR	DCIN1 DCIN2 (vertical phoenix connector)
2	RJ-45 + USB 3.2 stack connector (GEN2)	Lan1_USB12
3	RJ-45	Lan2
4	USB 3.2 Gen1 x 2	USB34
5	DisplayPort	DP2
6	DisplayPort/HDMI dual port stack up connector	Dp1+hdm1
7	HD audio interface (analog)	AUDIO1
8	Audio amplifier output pin header	AMP1
9	PCI Express x16 slot	PCIEX16_1
10	IMVP9.1 programming header	VR_PMB1
11	System Fan #1 connector	SYSFAN1
12	CPU FAN connector	CPUFAN1
13	EDP connector / LVDS connector	EDP1_LVDS1
14	LVDS VESA, JEIDA format selection pin header	JLVDS_VCON1
15	EDP Panel / LVDS Panel Voltage Selection	JEDP1_LVDS1
16	EDP / LVDS backlight inverter power connector	INV1
17	AT / ATX mode selection	JPSON1
18	8-bit general purpose I/O pin header	GPIO1
19	ESPI port 80 connector	ESPI_P80
20	COM1 connector (RS232)	COM1
21	SATA power	SATA_PWR2
22	COM2 connector (RS232/RS422/RS485)	COM2
23	SATA power	SATA_PWR1
24	PWRBTN#/ RESET#/HDD LED/SMBUS	JFP1
25	Power LED pin header	JFP2
26	Serial ATA interface connector	SATA2
27	Serial ATA interface connector	SATA1
28	USB 2.0 wafer	USB56
29	RTC / CMOS clear	JCMOS1
30	Flash descriptor security override pin header	JME1
31	M.2 M-Key connector	M2_M1
32	SPI BIOS flash pin header	SPI_CN1
33	M.2 E-Key connector	M2_E1
34	CMOS battery connector	BAT1
35	Case open connector	JCASE1
36	COM1 RI# selection pin header	JSETCOM1_V1

Table 1.1: Connector and Header List

37	Description	PCI Express x16 Bifurcation Part Reference: SW_PEGSEL1
----	-------------	--

1.5 Board Layout: Jumper and Connector Locations

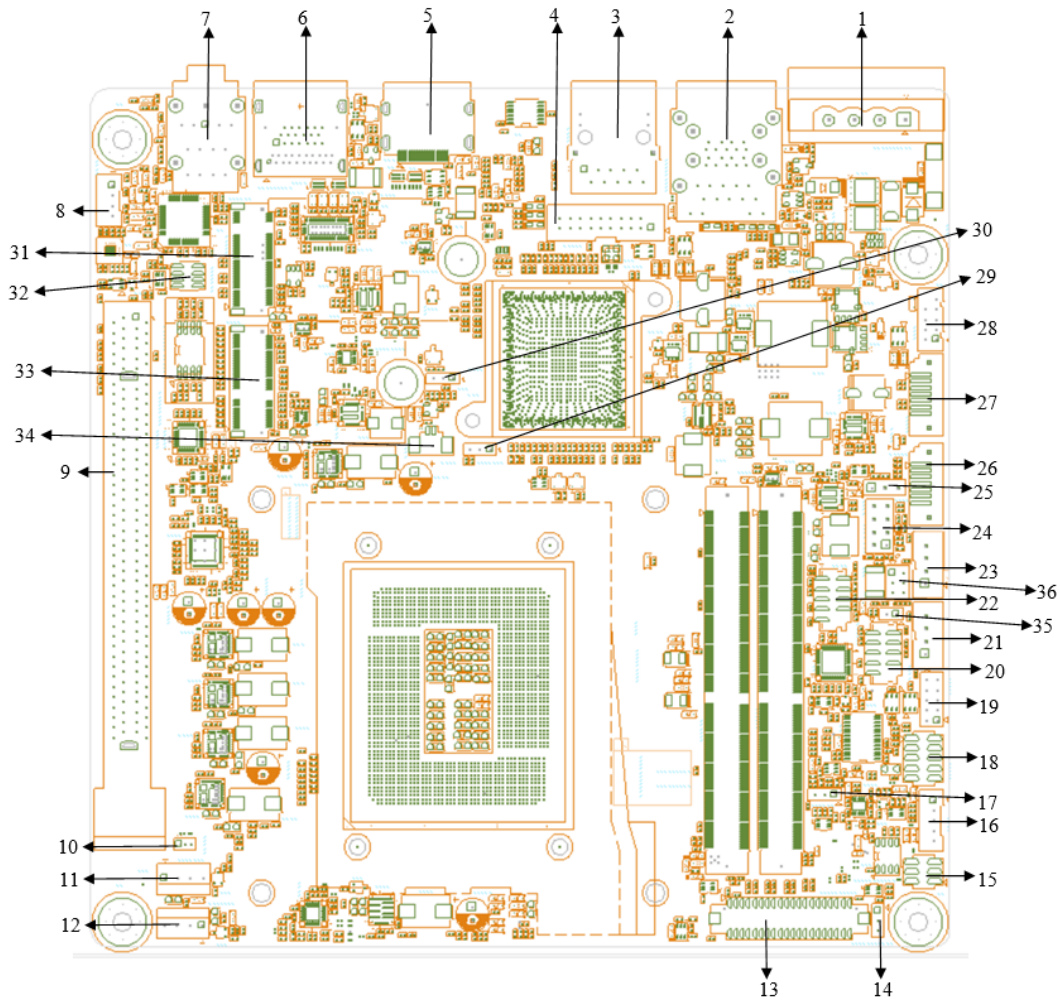

Figure 1.1 Jumper and Connector Locations (Top Side)

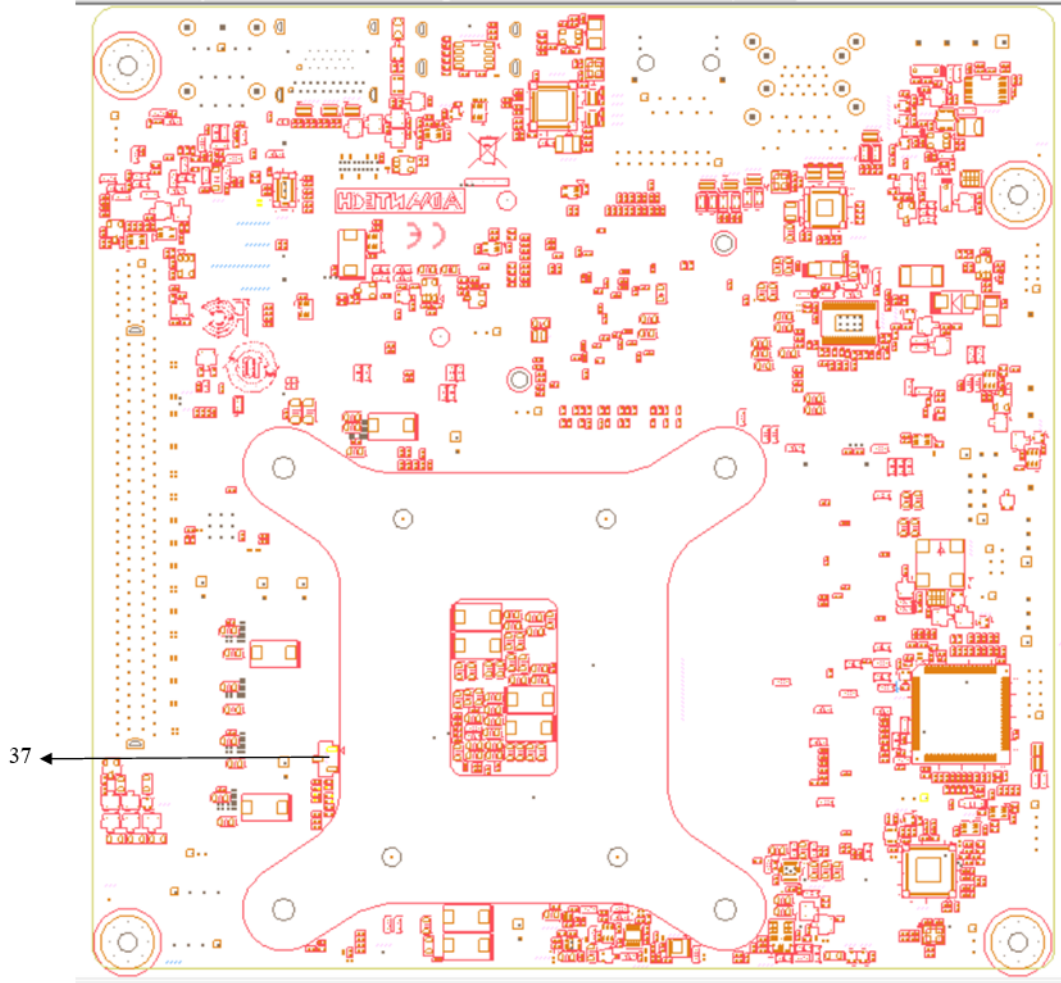

Figure 1.2 Jumper and Connector Locations (Bottom Side)

1.6 AIMB-279 Board Diagram

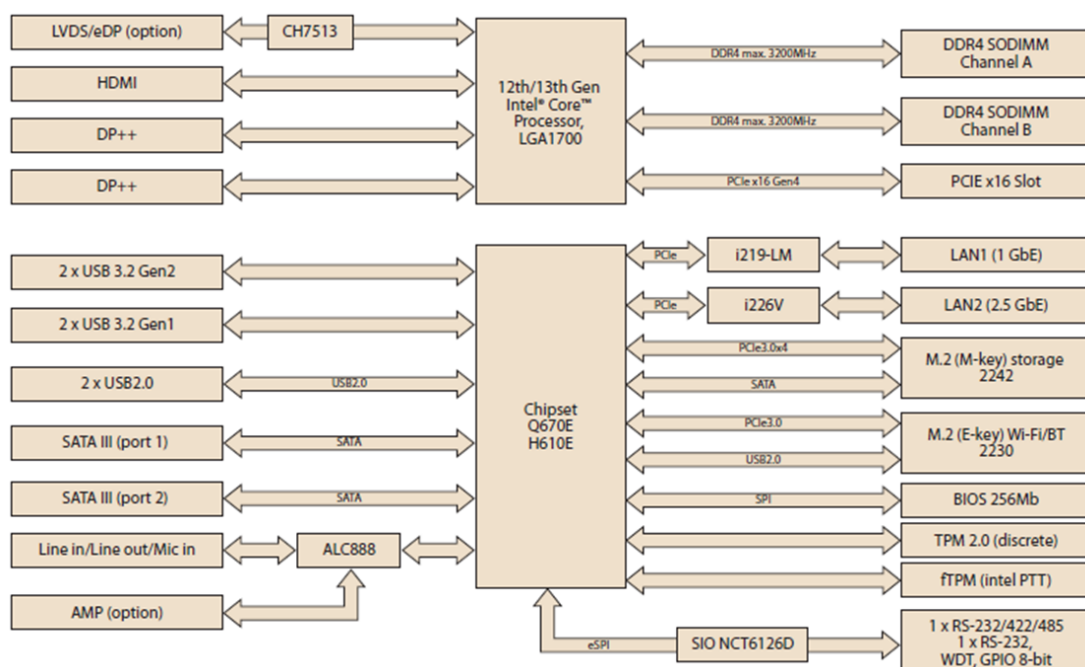

Figure 1.3 AIMB-279 Block Diagram

1.7 Safety Precautions

Warning! Always completely disconnect the power cord from the chassis whenever you work with the hardware. Do not make connections while the power is on. Sensitive electronic components can be damaged by sudden power surges. Only experienced electronics personnel should open the PC chassis.



Caution! Always ground yourself to remove any static charge before touching the motherboard. Modern electronic devices are very sensitive to electrostatic discharges. As a safety precaution, use a grounding wrist strap at all times. Place all electronic components on a static-dissipative surface or in a static-shielded bag when they are not in the chassis.



Caution! The computer is provided with a battery-powered real-time clock circuit. There is a danger of explosion if the battery is incorrectly replaced. Replace only with the same or equivalent type recommended by the manufacturer. Discard used batteries according to the manufacturer's instructions.



Caution! There is danger of a new battery exploding if it is incorrectly installed. Do not attempt to recharge, force open, or heat the battery. Replace the battery only with the same or equivalent type recommended by the manufacturer. Discard used batteries according to the manufacturer's instructions.



1.8 Jumper Settings

This section provides instructions on how to configure your motherboard by setting the jumpers. It also includes the motherboard's default settings and your options for each jumper.

1.8.1 How to Set Jumpers

You can configure your motherboard to match the needs of your application by setting the jumpers. A jumper is a metal bridge that closes an electrical circuit. It consists of two metal pins and a small metal clip (often protected by a plastic cover) that slides over the pins to connect them. To “close” (or turn ON) a jumper, you connect the pins with the clip. To “open” (or turn OFF) a jumper, you remove the clip. Sometimes a jumper consists of a set of three pins, labeled 1, 2, and 3. In this case you connect either pins 1 and 2, or 2 and 3. A pair of needle-nose pliers may be useful when setting jumpers.

1.8.2 CMOS Clear (JCMOS1)

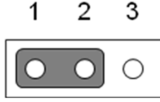
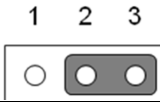

The AIMB-279 motherboard contains a jumper that can erase CMOS data and reset the system BIOS information. Normally this jumper should be set with pins 1-2 closed. If you want to reset the CMOS data, set CMOS1 to 2-3 closed for just a few seconds, and then move the jumper back to 1-2 closed. This procedure will reset the CMOS to its default setting.

Table 1.2: JCMOS1

Function	Jumper Settings
Keep CMOS data (default)	 1-2
Clear CMOS data	 2-3

1.8.3 ATX/AT Mode Selection (PSON1)

Table 1.3: ATX/AT Mode Selection (PSON1)

Function	Jumper Setting
ATX Mode (default)	
AT Mode	

1.8.4 eDP/LVDS Panel Voltage Selection (JEDP1_LVDS1)

Table 1.4: eDP/LVDS Panel Voltage Selection (JEDP1_LVDS1)

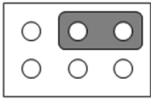
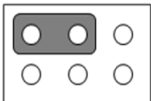
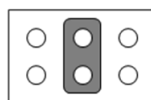
Function	Jumper Setting
Jumper position for +3.3V (default)	<p>2 4 6</p>  <p>1 3 5</p>
Jumper position for 5V	<p>2 4 6</p>  <p>1 3 5</p>
Jumper position for 12V	<p>2 4 6</p>  <p>1 3 5</p>

1.8.5 PCI Express x16 Bifurcation (SW1)

Table 1.5: PCI Express x16 Bifurcation (SW1)

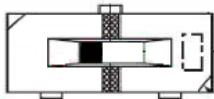
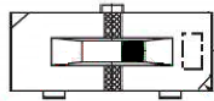
Function	Jumper Setting
1 X16 (Default)	
2 X8	

1.8.6 COM1_RI# Pin RI# / 5V / 12V Selection (JSETCOM1_V1)

Table 1.6: COM1_RI# Pin RI# / 5V / 12V Selection (JSETCOM1_V1)

Function	Jumper Setting
Jumper position for RI# (default)	<p>2 4 6</p>  <p>1 3 5</p>
Jumper position for 5V	<p>2 4 6</p>  <p>1 3 5</p>

Table 1.6: COM1_RI# Pin RI# / 5V / 12V Selection (JSETCOM1_V1)



1.9 System Memory

AIMB-279 has two sockets for a 260-pin DDR4 SODIMM. These sockets use 1.2V unbuffered double data rate synchronous DRAM (DDR SDRAM). DRAM is available in capacities of 4GB, 8GB, 16GB, and 32GB. The sockets can take any combination with SODIMMs of any size, giving a total memory size of 4GB, 8GB, 16GB, 32GB, and up to max 64GB.

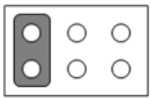
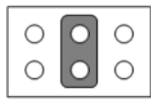
1.10 Memory Installation Procedures

To install a SODIMM, first make sure the two handles of the SODIMM socket are in the “open” position, i.e., the handles lean outward. Slowly slide the SODIMM module along the plastic guides on both ends of the socket. Then firmly but gently (avoid pushing down too hard) press the SODIMM module well down into the socket, until you hear a click when the two handles have automatically locked the memory module into the correct position of the SODIMM socket. To remove the memory module, just push both handles outward, and the memory module will be ejected by the mechanism.

1.11 Cache Memory

AIMB-279 supports a CPU with one of the following built-in full-speed last-level caches:

36MB for Intel® Core™ i9-13900E/i9-13900TE

30MB for Intel® Core™ i7-13700E/i7-13700TE

20MB for Intel® Core™ i5-13500E/i7-13500TE

12MB for Intel® Core™ i3-13100E/i7-13100TE

The built-in second-level cache in the processor yields much higher performance than conventional external cache memory.

1.12 Processor Installation

AIMB-279 is designed to support 12/13th Gen Intel® Core™ i9/i7/i5/i3, Pentium®, and Celeron® processors for the LG1700 socket.

Chapter 2

Connecting
Peripherals

2.1 Introduction

You can access most of the connectors from the top of the board as it is being installed in the chassis. If you have a number of cards installed or have a packed chassis, you may need to partially remove a card to make all the connections.

2.2 DC-In Power Connector (DCIN1)

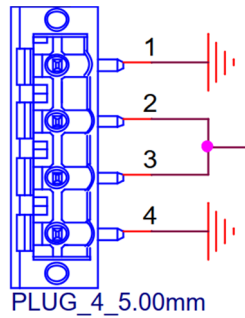

Table 2.1: DC-In Power Connector (DCIN1)

Pin	Signal
1	GND
2	ADAPTER VOLTAGE
3	ADAPTER VOLTAGE
4	GND

2.3 RJ-45 + USB 3.2 Stack Connector (LAN1_USB12)

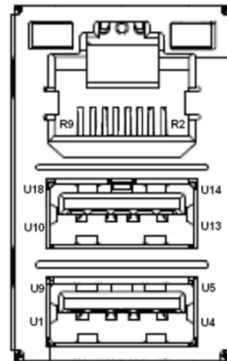

Table 2.2: RJ-45 + USB 3.2 Stack Connector (LAN1_USB12)

Pin	Signal	Pin	Signal
U1	VBUS	U10	VBUS
U2	D_1-	U11	D_2-
U3	D_1+	U12	D_2+
U4	GND	U13	GND
U5	RX_1-	U14	RX_2-
U6	RX_1+	U15	RX_2+
U7	GND	U16	GND
U8	TX_1-	U17	TX_2-
U9	TX_1+	U18	TX_2+

Table 2.2: RJ-45 + USB 3.2 Stack Connector (LAN1_USB12)

R2	LAN1_MDI_P0	R6	LAN1_MDI_P2
R3	LAN1_MDI_N0	R7	LAN1_MDI_N2
R4	LAN1_MDI_P1	R8	LAN1_MDI_P3
R5	LAN1_MDI_N1	R9	LAN1_MDI_N3

2.4 RJ-45 Connector (LAN2)

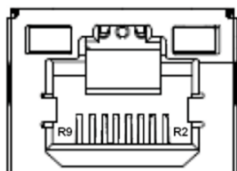
**Table 2.3: RJ-45 Connector (LAN2)**

Pin	Signal	Pin	Signal
R2	LAN2_MDI_P0	R6	LAN2_MDI_P2
R3	LAN2_MDI_N0	R7	LAN2_MDI_N2
R4	LAN2_MDI_P1	R8	LAN2_MDI_P3
R5	LAN2_MDI_N1	R9	LAN2_MDI_N3

2.5 Universal Serial Bus 3.2 (USB34)

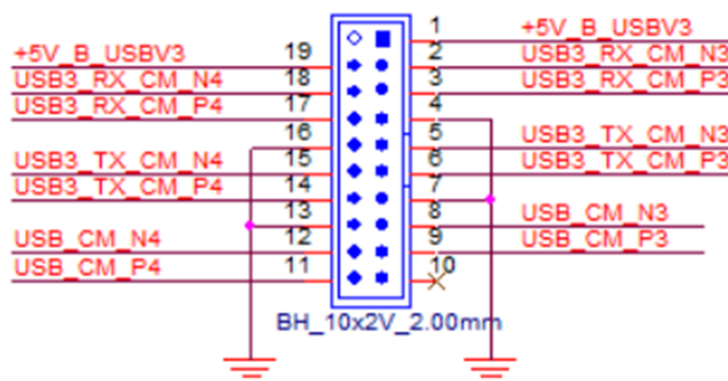
**Table 2.4: Universal Serial Bus 3.2 (USB34)**

Pin	Signal	Pin	Signal
	NC	1	+5V_B_USBV3
19	+5V_B_USBV3	2	USB3_RX_CM_N3
18	USB3_RX_CM_N4	3	USB3_RX_CM_P3
17	USB3_RX_CM_P4	4	GND
16	GND	5	USB3_TX_CM_N3
15	USB3_TX_CM_N4	6	USB3_TX_CM_P3
14	USB3_TX_CM_P4	7	GND
13	GND	8	USB_CM_N3
12	USB_CM_N4	9	USB_CM_P3
11	USB_CM_P4	10	NC

2.6 DisplayPort Connector (DP2)

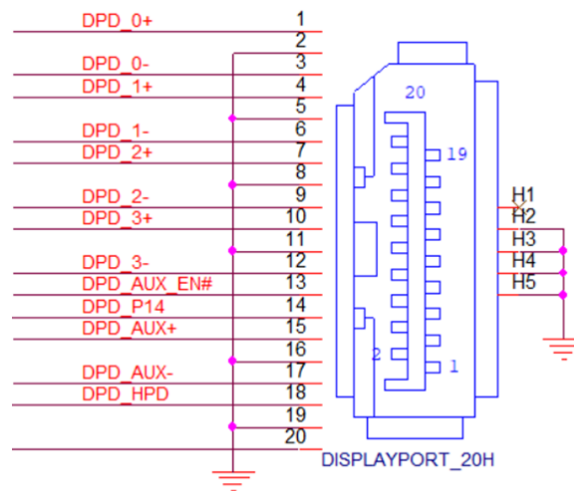

Table 2.5: DisplayPort Connector (DP2)

Pin	Signal	Pin	Signal
1	DPD_0+	2	GND
3	DPD_0-	4	DPD_1+
5	GND	6	DPD_1-
7	DPD_2+	8	GND
9	DPD_2-	10	DPD_3+
11	GND	12	DPD_3-
13	DPD_AUX_EN#	14	DPD_P14
15	DPD_AUX+	16	GND
17	DPD_AUX-	18	DPD_HPDP
19	GND	20	+V3.3_DP

2.7 DisplayPort Dual Port Stack-Up Connector (DP1+HDMI1)

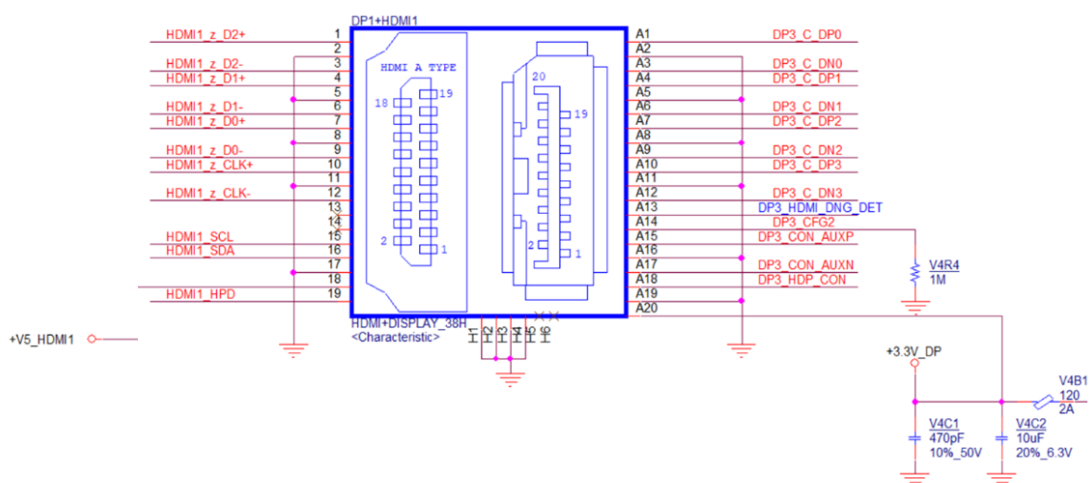
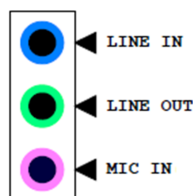

Table 2.6: DisplayPort Dual Port Stack-Up Connector (DP1+HDMI1)

Pin	Signal	Pin	Signal
1	HDMI1_z_D2+	A21	DP2_0+
2	GND	A22	GND
3	HDMI1_z_D2-	A23	DP2_0-
4	HDMI1_z_D1+	A24	DP2_1+
5	GND	A25	GND
6	HDMI1_z_D1-	A26	DP2_1-
7	HDMI1_z_D0+	A27	DP2_2+
8	GND	A28	GND
9	HDMI1_z_D0-	A29	DP2_2-
10	HDMI1_z_CLK+	A30	DP2_3+
11	GND	A31	GND
12	HDMI1_z_CLK-	A32	DP2_3-
13		A33	DP2_AUX_EN#
14		A34	GND
15	HDMI1_SCL	A35	DP2_AUX+
16	HDMI1_SDA	A36	GND
17	GND	A37	DP2_AUX-
18	+V5_HDMI1	A38	DP2_HPD
19	HDMI1_HPD	A39	GND
		A40	+V3.3_DP1

2.8 HD Audio Interface (Analog) (AUDIO1)

**Table 2.7: HD Audio Interface (Analog) (AUDIO1)**

Pin	Signal
1	MIC IN
2	LINE OUT
3	LINE IN

2.9 Audio Amplifier Output Pin Header (AMP1)

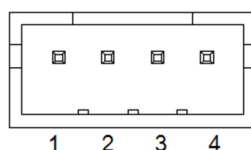

Table 2.8: Audio Amplifier Output Pin Header (AMP1)

Pin	Signal
1	AMP OUT – R+
2	AMP OUT – R-
3	AMP OUT – L-
4	AMP OUT – L+

2.10 PCI Express x16 Slot (PCIEX16_1)

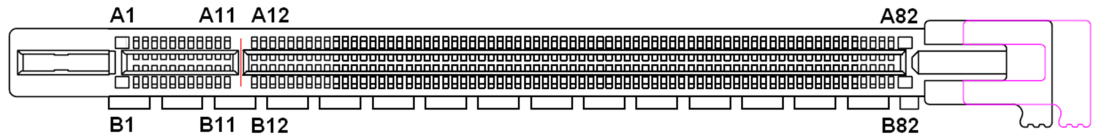

Table 2.9: PCI Express x16 Slot (PCIEX16_1)

Pin	Signal	Pin	Signal
B1	+12V	A1	PRSNT1#
B2	+12V	A2	+12V
B3	+12V	A3	+12V
B4	GND	A4	GND
B5	SMB_CLK	A5	Reserved
B6	SMB_DATA	A6	Reserved
B7	GND	A7	Reserved
B8	+3.3V	A8	Reserved
B9	Reserved	A9	+3.3V
B10	+3.3VAUX	A10	+3.3V
B11	WAKE#	A11	PWRGD
B12	Reserved	A12	GND
B13	GND	A13	REFCLK+
B14	TX0+	A14	REFCLK-
B15	TX0-	A15	GND
B16	GND	A16	RX0+
B17	Reserved	A17	RX0-
B18	DETECT#	A18	GND
B19	TX1+	A19	Advantech define
B20	TX1-	A20	GND
B21	GND	A21	RX1+
B22	GND	A22	RX1-
B23	TX2+	A23	GND
B24	TX2-	A24	GND
B25	GND	A25	RX2+
B26	GND	A26	RX2-
B27	TX3+	A27	GND
B28	TX3-	A28	GND
B29	GND	A29	RX3+
B30	Reserved	A30	RX3-
B31	Reserved	A31	GND

Table 2.9: PCI Express x16 Slot (PCIEX16_1)			
B32	GND	A32	Advantech define
B33	TX4+	A33	Reserved
B34	TX4-	A34	GND
B35	GND	A35	RX4+
B36	GND	A36	RX4-
B37	TX5+	A37	GND
B38	TX5-	A38	GND
B39	GND	A39	RX5+
B40	GND	A40	RX5-
B41	TX6+	A41	GND
B42	TX6-	A42	GND
B43	GND	A43	RX6+
B44	GND	A44	RX6-
B45	TX7+	A45	GND
B46	TX7-	A46	GND
B47	GND	A47	RX7+
B48	Reserved	A48	RX7-
B49	GND	A49	GND
B50	TX8+	A50	Reserved
B51	TX8-	A51	GND
B52	GND	A52	RX8+
B53	GND	A53	RX8-
B54	TX9+	A54	GND
B55	TX9-	A55	GND
B56	GND	A56	RX9+
B57	GND	A57	RX9-
B58	TX10+	A58	GND
B59	TX10-	A59	GND
B60	GND	A60	RX10+
B61	GND	A61	RX10-
B62	TX11+	A62	GND
B63	TX11-	A63	GND
B64	GND	A64	RX11+
B65	GND	A65	RX11-
B66	TX12+	A66	GND
B67	TX12-	A67	GND
B68	GND	A68	RX12+
B69	GND	A69	RX12-
B70	TX13+	A70	GND
B71	TX13-	A71	GND
B72	GND	A72	RX13+
B73	GND	A73	RX13-
B74	TX14+	A74	GND
B75	TX14-	A75	GND
B76	GND	A76	RX14+
B77	GND	A77	RX14-
B78	TX15+	A78	GND

Table 2.9: PCI Express x16 Slot (PCIEX16_1)

B79	TX15-	A79	GND
B80	GND	A80	RX15+
B81	Reserved	A81	RX15-
B82	Reserved	A82	GND

2.11 IMVP9.1 Programming Header (VR_PMB1)



Table 2.10: IMVP9.1 Programming Header (JSMB1)

Pin	Signal
1	DATA
2	GND
3	CLK

2.12 System Fan #1 Connector (SYSFAN1)



Table 2.11: System Fan #1 Connector (SYSFAN1)

Pin	Signal
1	GND
2	SYSTEM FAN VCC
3	SYSTEM FAN SPEED
4	SYSTEM FAN PWM

2.13 CPU FAN Connector (CPUFAN1)



Table 2.12: CPU FAN Connector (CPUFAN1)

Pin	Signal
1	GND
2	CPU FAN VCC
3	CPU FAN SPEED
4	CPU FAN PWM

2.14 EDP Connector / LVDS Connector (EDP1_LVDS1)

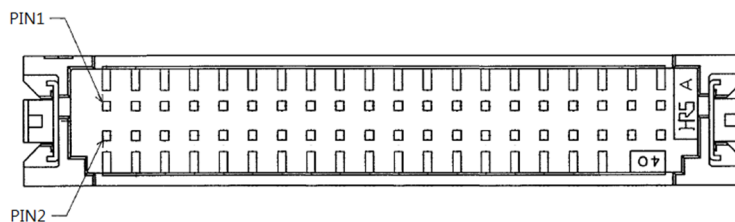

Table 2.13: LVDS Connector (LVDS1)

Pin	Signal	Pin	Signal
1	VDD	2	VDD
3	LVDS DETECT#	4	GND
5	VDD	6	VDD
7	LVDS_OD0-	8	LVDS_ED0-
9	LVDS_OD0+	10	LVDS_ED0+
11	GND	12	GND
13	LVDS_OD1-	14	LVDS_ED1-
15	LVDS_OD1+	16	LVDS_ED1+
17	GND	18	GND
19	LVDS_OD2-	20	LVDS_ED2-
21	LVDS_OD2+	22	LVDS_ED2+
23	GND	24	GND
25	LVDS_OCK-	26	LVDS_ECK-
27	LVDS_OCK+	28	LVDS_ECK+
29	GND	30	GND
31	N.C	32	N.C
33	GND	34	GND
35	LVDS_OD3-	36	LVDS_ED3-
37	LVDS_OD3+	38	LVDS_ED3+
39	LVDS ENBKL	40	LVDS VCON

Table 2.14: EDP Connector (EDP1)

Pin	Signal	Pin	Signal
1	VDD	2	VDD
3	LVDS DETECT#	4	GND
5	VDD	6	VDD
7	EDP_TX2-	8	N.C
9	EDP_TX2+	10	N.C
11	GND	12	GND
13	EDP_TX1-	14	N.C
15	EDP_TX1+	16	N.C
17	GND	18	GND
19	EDP_TX0-	20	N.C
21	EDP_TX0+	22	N.C
23	GND	24	GND
25	EDP_TX3-	26	N.C

Table 2.14: EDP Connector (EDP1)

27	EDP_TX3+	28	N.C
29	GND	30	GND
31	EDP_AUX+	32	EDP_AUX-
33	GND	34	EDP_HPDP
35	N.C	36	N.C
37	N.C	38	N.C
39	N.C	40	GND

2.15 LVDS VESA, JEIDA Format Selection Pin Header (JLVDS_VCON1)

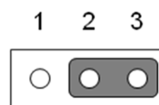

Table 2.15: LVDS VESA, JEIDA Format Selection Pin Header (JLVDS_VCON1)

Pin	Signal
1	+3.3V
2	Advantech define
3	GND

2.16 EDP Panel / LVDS Panel Voltage Selection (JEDP1_LVDS1)

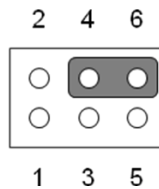

Table 2.16: EDP Panel / LVDS Panel Voltage Selection (JEDP1_LVDS1)

Pin	Signal	Pin	Signal
1	NC	2	+5V
3	+12V	4	VDD
5	NC	6	+3.3V

2.17 EDP / LVDS Backlight Inverter Power Connector (INV1)

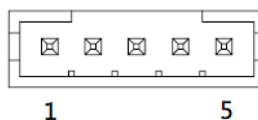

Table 2.17: EDP / LVDS Backlight Inverter Power Connector (INV1)

Pin	Signal
1	+12V
2	GND
3	BKL EN
4	BKL CTRL
5	+5V

2.18 AT / ATX Mode Selection (PSON1)

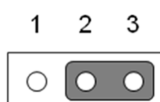

Table 2.18: AT / ATX Mode Selection (PSON1)

Pin	Signal
1	VCCAT
2	+3.3V
3	VCCATX

2.19 8-Bit General Purpose I/O Pin Header (GPIO1)

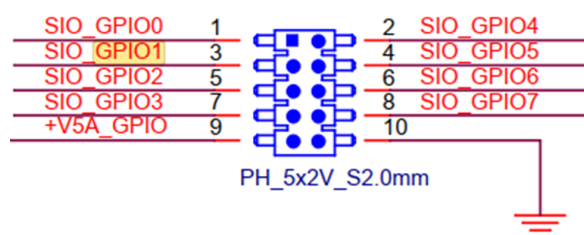

Table 2.19: 8-Bit General Purpose I/O Pin Header (GPIO1)

Pin	Signal	Pin	Signal
1	SIO_GPIO0	2	SIO_GPIO4
3	SIO_GPIO1	4	SIO_GPIO5
5	SIO_GPIO2	6	SIO_GPIO6
7	SIO_GPIO3	8	SIO_GPIO7
9	+V5A_GPIO	10	GND

2.20 ESPI Port 80 Connector (ESPI_P80)

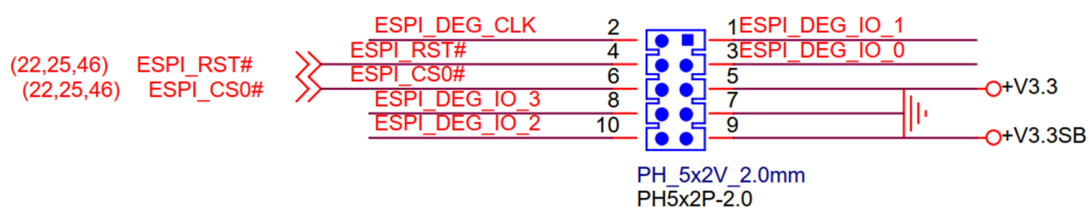

Table 2.20: ESPI Port 80 Connector (ESPI1)

Pin	Signal	Pin	Signal
1	ESPI_DEG_IO_1	2	ESPI_DEG_CLK
3	ESPI_DEG_IO_0	4	ESPI_RST#
5	+V3.3	6	ESPI_CS0#
7	GND	8	ESPI_DEG_IO_3
9	+V3.3SB	10	ESPI_DEG_IO_2

2.21 COM1 Connector (COM1)

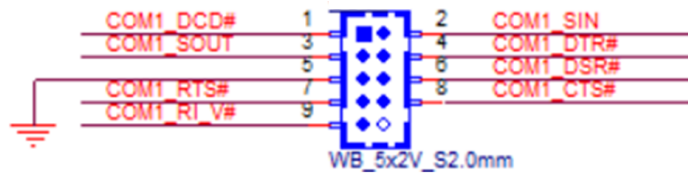

Table 2.21: COM1 Connector (COM1)

Pin	Signal	Pin	Signal
1	COM1_DCD#	2	COM1_SIN
3	COM1_SOUT	4	COM1_DTR#
5	GND	6	COM1_DSR#
7	COM1_RTS#	8	COM1_CTS#
9	COM1_RI_V#	10	NC

2.22 SATA Power (SATA_PWR2)

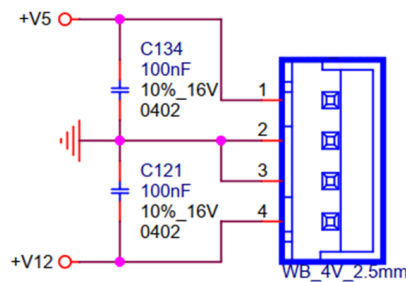

Table 2.22: SATA Power (SATA_PWR2)

Pin	Signal
1	+V5
2	GND
3	GND
4	+V12

2.23 COM2 Connector (COM2)

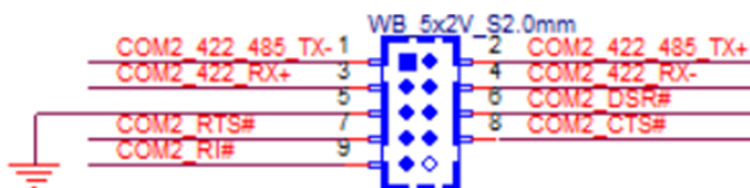

Table 2.23: COM2 Connector (COM2)

Pin	Signal	Pin	Signal
1	COM2_422_485_TX-	2	COM2_422_485_TX+
3	COM2_422_RX+	4	COM2_422_RX-
5	GND	6	COM2_DSR#
7	COM2_RTS#	8	COM2_CTS#
9	COM2_RI#	10	NC

2.24 SATA Power (SATA_PWR1)

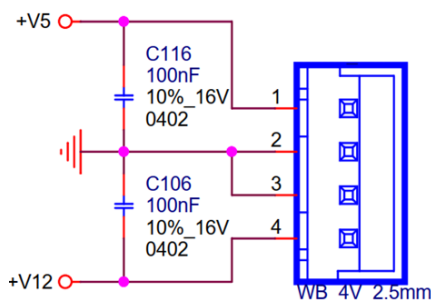

Table 2.24: SATA Power (SATA_PWR1)

Pin	Signal
1	+V5
2	GND
3	GND
4	+V12

2.25 PWRBTN#/ RESET#/HDD LED/SMBUS (JFP1)

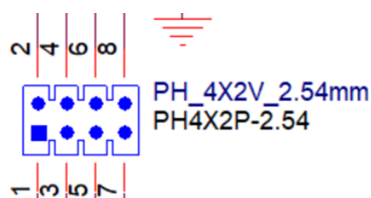

Table 2.25: PWRBTN#/ RESET#/HDD LED/SMBUS (JFP1)

Pin	Signal	Pin	Signal
1	HDD LED+	2	Power Button
3	HDD LED-	4	GND
5	SMB_DATA	6	RESET Button-
7	SMB_CLK	8	GND

2.26 Power LED Pin Header (JFP2)

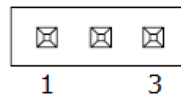

Table 2.26: Power LED Pin Header (JFP2)

Pin	Signal
1	Power LED+
2	NC
3	Power LED-

2.27 Serial ATA Interface Connector (SATA2)

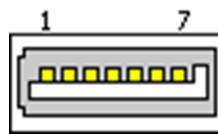

Table 2.27: Serial ATA Interface Connector (SATA2)

Pin	Signal
1	GND
2	TX+
3	TX-
4	GND
5	RX-
6	RX+
7	GND

2.28 Serial ATA Interface Connector (SATA1)

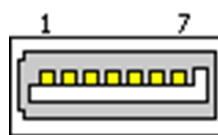

Table 2.28: Serial ATA Interface Connector (SATA1)

Pin	Signal
1	GND
2	TX+
3	TX-
4	GND
5	RX-
6	RX+
7	GND

2.29 USB 2.0 Front Panel Header (USB56)

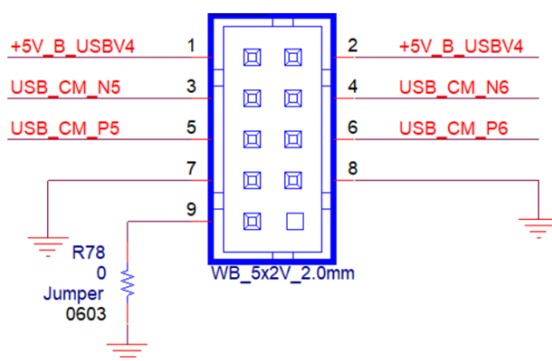

Table 2.29: USB 2.0 Front Panel Header (USB56)

Pin	Signal	Pin	Signal
1	+5V_B_USBV4	2	+5V_B_USBV4
3	USB_CM_N5	4	USB_CM_N6
5	USB_CM_P5	6	USB_CM_P6
7	GND	8	GND
9	GND	10	X

2.30 CMOS Mode Selection (JCMOS1)



Table 2.30: CMOS Mode Selection (JCMOS1)

Pin	Signal
1	NC
2	RTC_RESET#
3	GND

2.31 Flash Descriptor Security Override Pin Header (JME1)



Table 2.31: Flash Descriptor Security Override Pin Header (ME1)

Pin	Signal
1	Advantech defined
2	Advantech defined
3	NC

2.32 M.2 M-Key Connector (M2_M1)

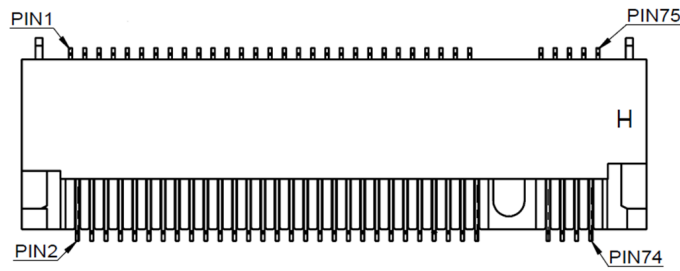

Table 2.32: M.2 M-Key Connector (M2M1)

Pin	Signal	Pin	Signal
1	GND	2	3.3V
3	GND	4	3.3V
5	PERn3	6	N/C
7	PERp3	8	N/C
9	GND	10	DAS/DSS# (I/O)/LED1# (I)(0/3.3V)
11	PETn3	12	3.3V
13	PETp3	14	3.3V
15	GND	16	3.3V
17	PERn2	18	3.3V
19	PERp2	20	N/C
21	GND	22	N/C
23	PETn2	24	N/C
25	PETp2	26	N/C
27	GND	28	N/C
29	PERn1	30	N/C
31	PERp1	32	N/C
33	GND	34	N/C
35	PETn1	36	N/C
37	PETp1	38	DEVSLP (O)
39	GND	40	N/C
41	PERn0/SATA-B+	42	N/C
43	PERp0/SATA-B-	44	N/C
45	GND	46	N/C
47	PETn0/SATA-A-	48	N/C
49	PETp0/SATA-A+	50	PERST# (O)(0/3.3V) or N/C
51	GND	52	CLKREQ# (I/O)(0/3.3V) or N/C
53	REFCLKn	54	PEWAKE# (I/O)(0/3.3V) or N/C
55	REFCLKp	56	N/C
57	GND	58	N/C
59	Connector key	60	Connector key
61	Connector key	62	Connector key
63	Connector key	64	Connector key
65	Connector key	66	Connector key
67	N/C	68	SUSCLK(32kHz) (O)(0/3.3V)
69	PEDET (NC-PCIe/GND-SATA)	70	3.3V

Table 2.32: M.2 M-Key Connector (M2M1)

71	GND	72	3.3V
73	GND	74	3.3V
75	GND		

2.33 SPI BIOS Flash Pin Header (SPI_CN1)

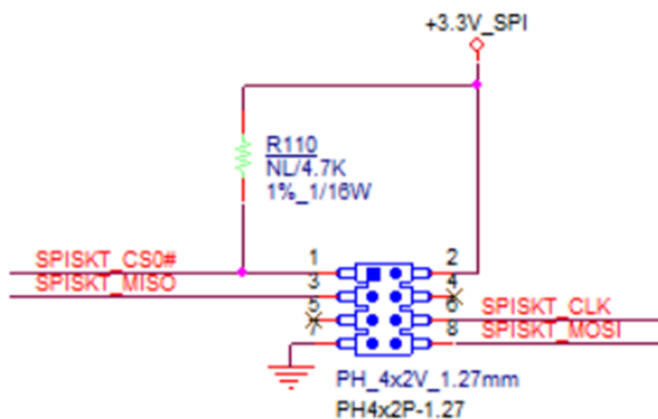
**Table 2.33: SPI BIOS Flash Pin Header (SPI_CN1)**

Pin	Signal	Pin	Signal
1	SPISKT_CS0#	2	+3.3V_SPI
3	SPISKT_MISO	4	NC
5	NC	6	SPISKT_CLK
7	GND	8	SPISKT_MOSI

2.34 M.2 E-Key Connector (M2_E1)

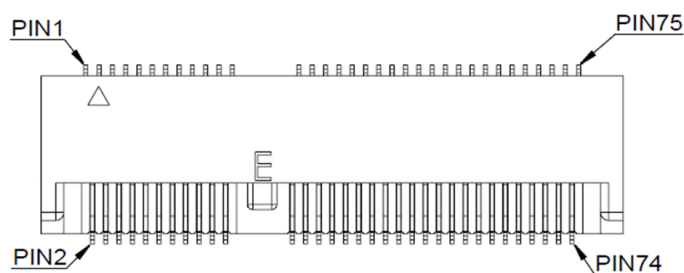
**Table 2.34: M.2 E-Key Connector (M2E1)**

Pin	Signal	Pin	Signal
1	GND	2	+3.3V
3	USB_D+	4	+3.3V
5	USB_D-	6	WLAN_LED1#
7	GND	8	BT_PCMCLK
9	CNV_WR_D1-	10	BT_PCMFRM
11	CNV_WR_D1+	12	BT_PCMIN
13	GND	14	BT_PCMOUT
15	CNV_WR_D0-	16	BT_LED#
17	CNV_WR_D0+	18	GND
19	GND	20	UART WAKE#

Table 2.34: M.2 E-Key Connector (M2E1)

21	CNV_WR_CLK-	22	CNV_BRI_RSP
23	CNV_WR_CLK+	24	Connector key
25	Connector key	26	Connector key
27	Connector key	28	Connector key
29	Connector key	30	Connector key
31	Connector key	32	CNV_RGI_DT_R
33	GND	34	CNV_RGI_RSP
35	PETp0	36	CNV_BRI_DT_R
37	PETn0	38	CL_RST#
39	GND	40	CL_DAT
41	PERp0	42	CL_CLK
43	PERn0	44	CNV_GNSS_PA_BLANKING
45	GND	46	CNV_MFUART2_TXD
47	REFCLKp0	48	CNV_MFUART2_RXD
49	REFCLKn0	50	SUSCLK
51	GND	52	WLAN_RST#
53	CLKREQ0#	54	BT_RF_KILL#
55	PEWAKE0#	56	WIFI_RF_KILL#
57	GND	58	NC
59	CNV_WT_D1-	60	NC
61	CNV_WT_D1+	62	NC
63	GND	64	NC
65	CNV_WT_D0-	66	NC
67	CNV_WT_D0+	68	NC
69	GND	70	NC
71	CNV_WT_CLK-	72	+3.3V
73	CNV_WT_CLK+	74	+3.3V
75	GND		

2.35 CMOS Battery Connector (BAT1)

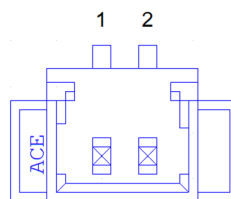
**Table 2.35: CMOS Battery Connector (BAT1)**

Pin	Signal
1	+VBAT
2	GND

2.36 Case Open connector (JCASE1)

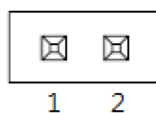

Table 2.36: Case Open Connector (JCASE1)

Pin	Signal
1	Case Open
2	GND

2.37 COM1 RI# Selection Pin Header (JSETCOM1_V1)

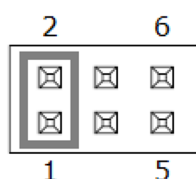

Table 2.37: COM1 RI# Selection Pin Header (JSETCOM1_V1)

Pin	Signal	Pin	Signal
1	RI# [1]	2	Advantech define
3	Advantech define	4	+5V
5	+12V	6	Advantech define

2.38 PCI Express x16 Bifurcation (SW_PEGSEL1)

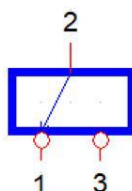

Table 2.38: PCI Express x16 Bifurcation (SW_PEGSEL1)

Pin	Signal
1	VCC_CFG
2	CFG
3	GND

Chapter 3

BIOS Operation

3.1 Introduction

With the AMI BIOS Setup program, you can modify BIOS settings and control the special features of your computer. The Setup program uses a number of menus for making changes and turning special features on or off. This chapter describes the basic navigation of the AIMB-279 setup screens.

3.2 BIOS Setup

The AIMB-279 Series system has AMI BIOS built in, with a CMOS SETUP utility that allows users to configure required settings or to activate certain system features. The CMOS Setup saves the configuration in the CMOS RAM of the motherboard. When the power is turned off, the battery on the board supplies the necessary power to preserve the CMOS RAM.

When the power is turned on, press the button during the BIOS POST (Power-On Self Test) to access the CMOS Setup screen.

Control Keys	
< ↑ >< ↓ >< ← >< → >	Move to select item
<Enter>	Select item
<Esc>	Main Menu - Quit without saving changes to the CMOS Sub-Menu - Exit current page and return to the Main Menu
<Page Up/+>	Increase the numeric value or make changes
<Page Down/->	Decrease the numeric value or make changes
<F1>	General help, for the Setup sub-menu
<F2>	Item help
<F5>	Loads previous values
<F7>	Loads setup defaults
<F10>	Saves all CMOS changes

3.2.1 Main Menu

Press to enter the AMI BIOS CMOS Setup Utility. The Main Menu will appear on the screen. Use the arrow keys to select among the items and press <Enter> to accept or enter the sub-menu.

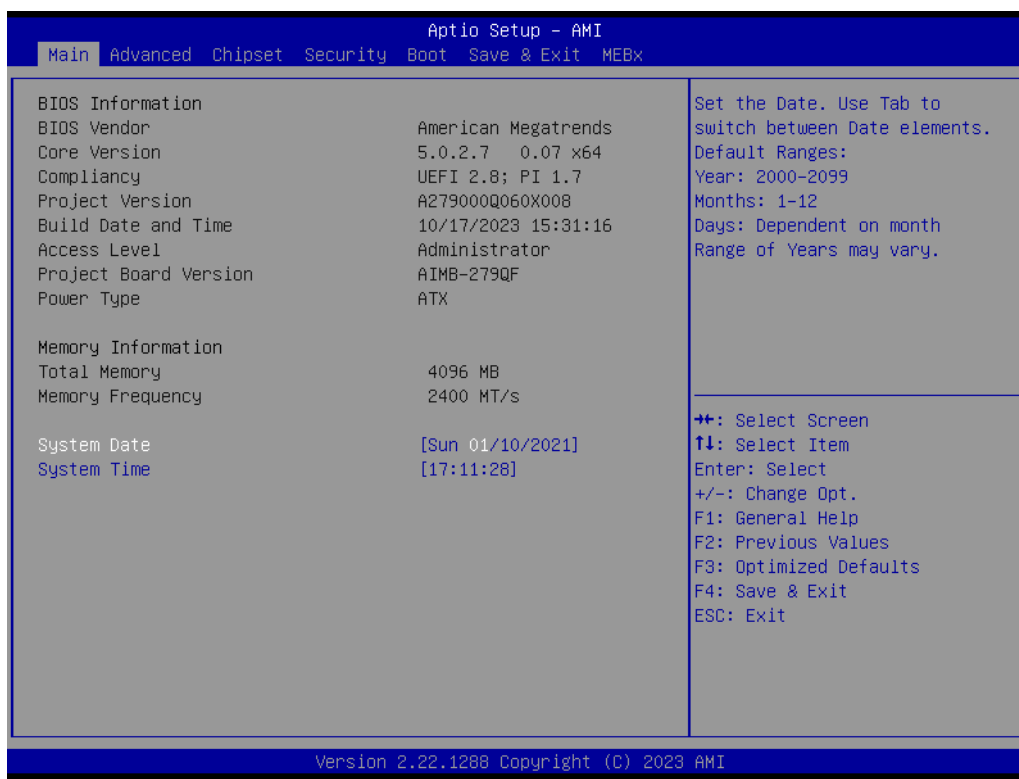

Figure 3.1

The Main BIOS setup screen has two main frames. The left frame displays all the options that can be configured. Grayed-out options cannot be configured; options in blue can. The right frame displays the key legend.

Above the key legend is an area reserved for a text message. When an option is selected in the left frame, it is highlighted in white. Often a text message will accompany it.

■ System Time / System Date

Use this option to change the system time and date. Highlight the System Time or System Date using the <Arrow> keys. Enter new values via the keyboard. Press the <Tab> or <Arrow> keys to move between fields. The date must be entered in MM/DD/YY format. The time must be entered in HH:MM:SS format.

3.2.2 Advanced BIOS Features

Select the Advanced tab from the AIMB-278 setup screen to enter the Advanced BIOS Setup screen. You can select any of the items in the left frame of the screen, such as CPU Configuration, to go to the sub-menu for that item. You can display an Advanced BIOS Setup option by highlighting it using the <Arrow> keys. All Advanced BIOS Setup options are described in this section. The Advanced BIOS Setup screen is shown below. The sub-menus are described on the following pages.

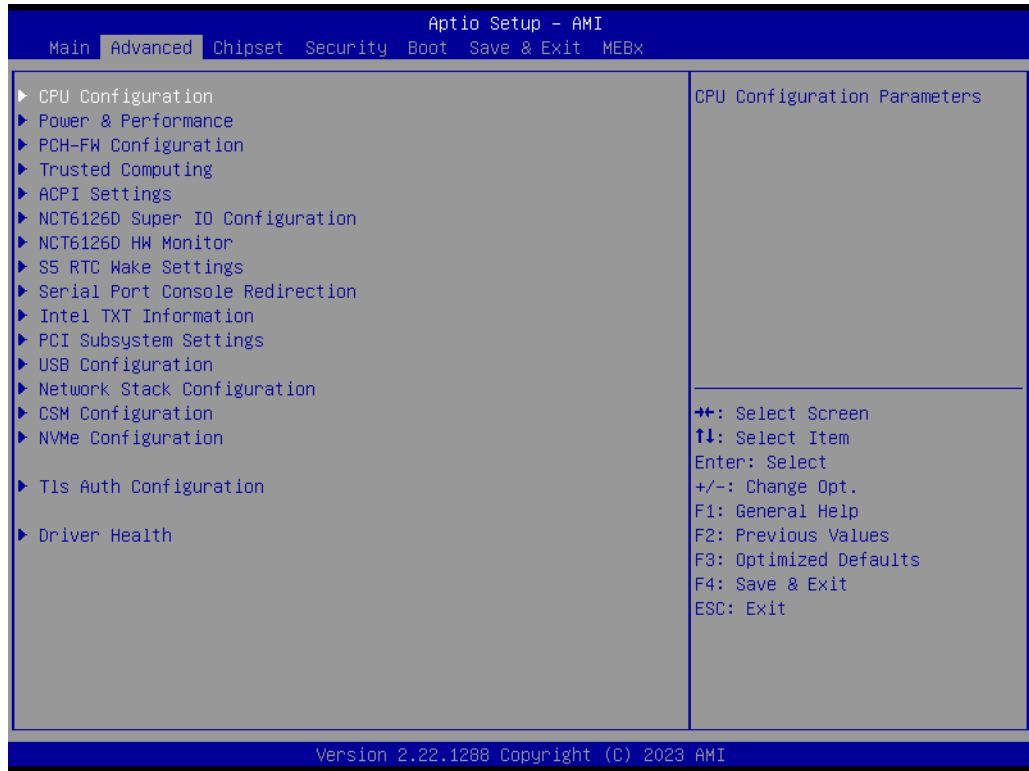

Figure 3.2

3.2.2.1 CPU Configuration

Advanced → CPU Configuration

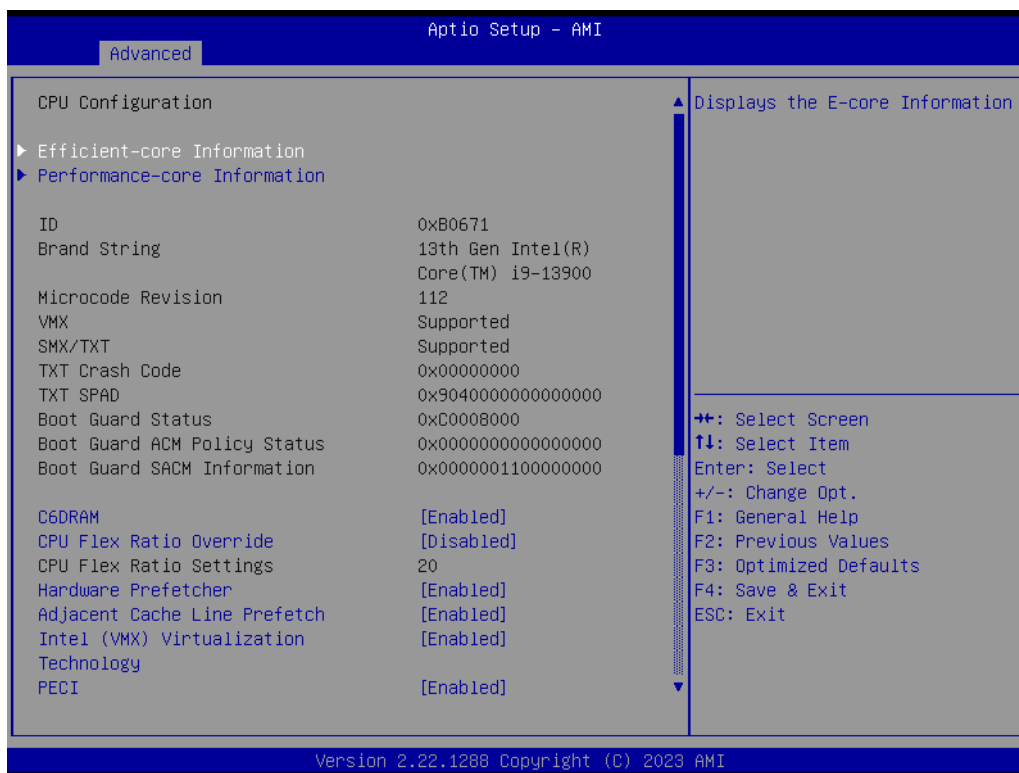

Figure 3.3

Efficient-Core Information

Advanced → CPU Configuration → Efficient-Core Information

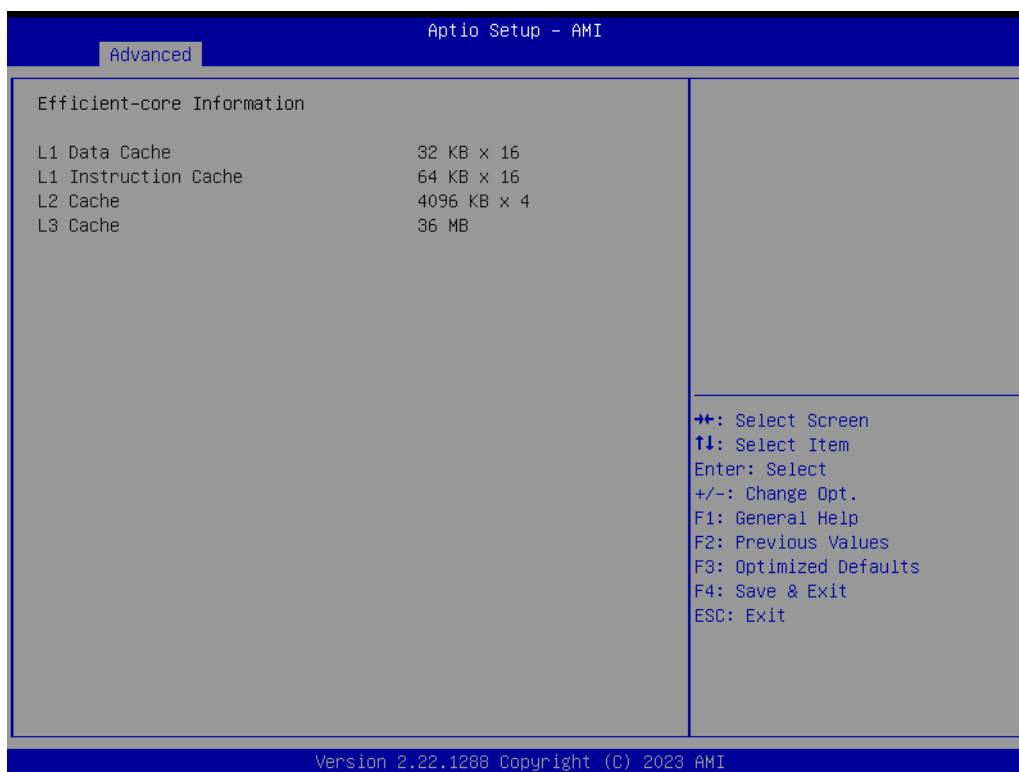

Figure 3.4

Performance-Core Information

Advanced → CPU Configuration → Performance-Core Information

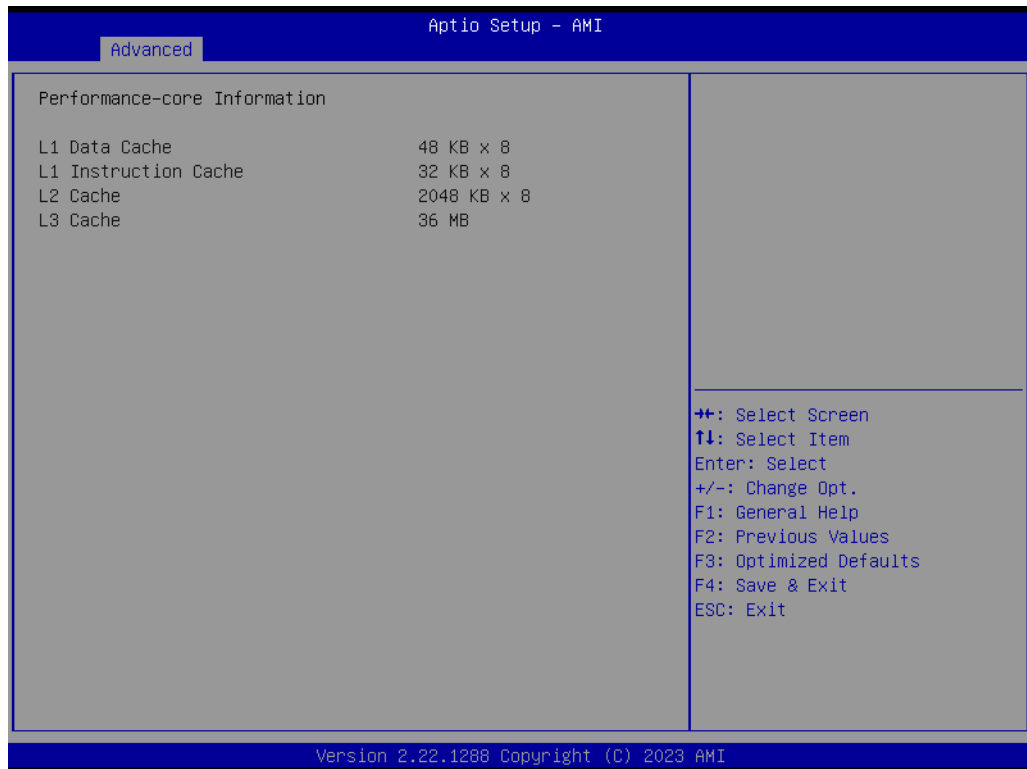

Figure 3.5

CPU SMM Enhancement

Advanced → CPU SMM Enhancement



Figure 3.6

3.2.2.2 Power & Performance

Advanced → Power & Performance

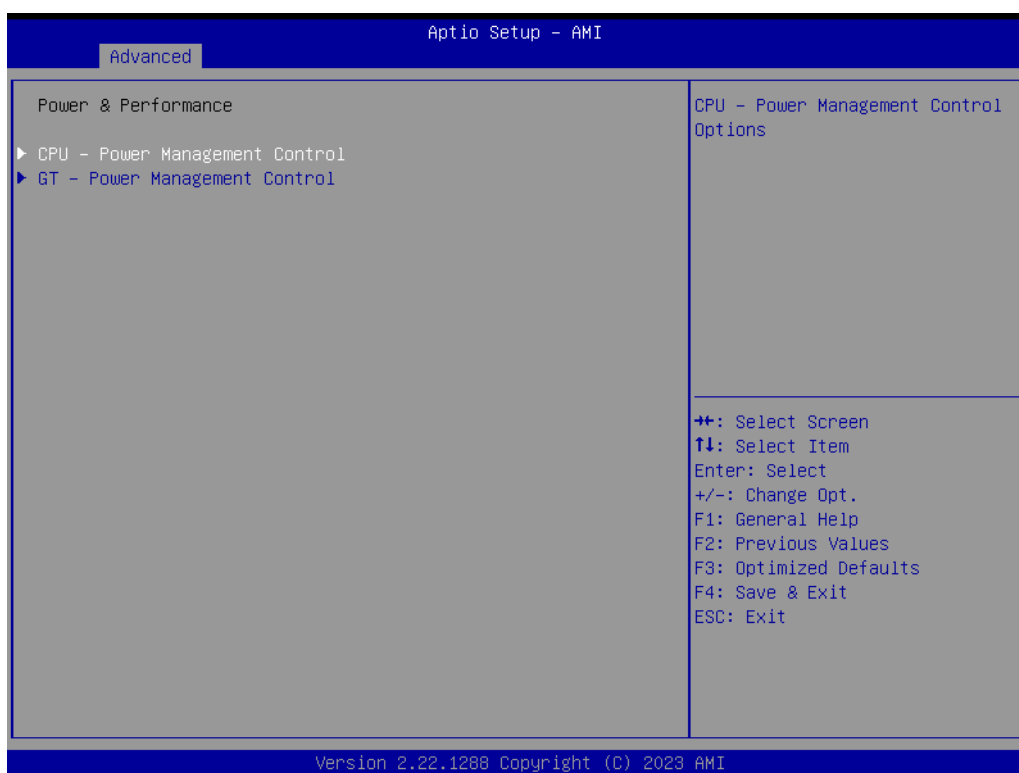

Figure 3.7

CPU - Power Management Control

Advanced → Power & Performance → CPU - Power Management Control

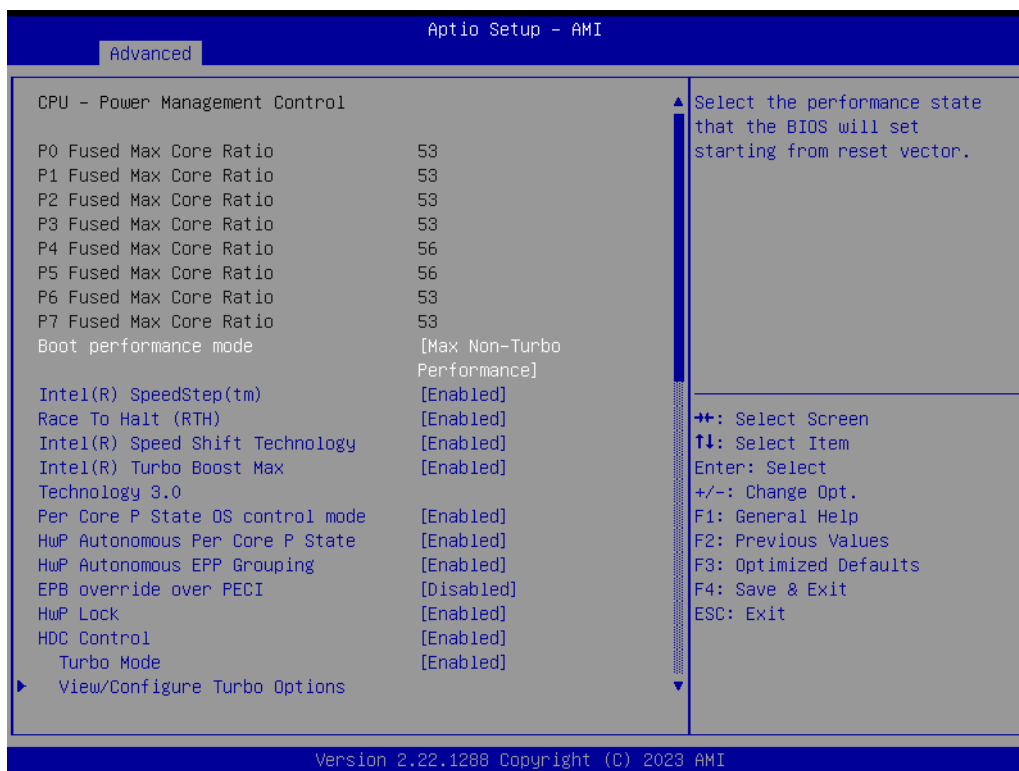

Figure 3.8

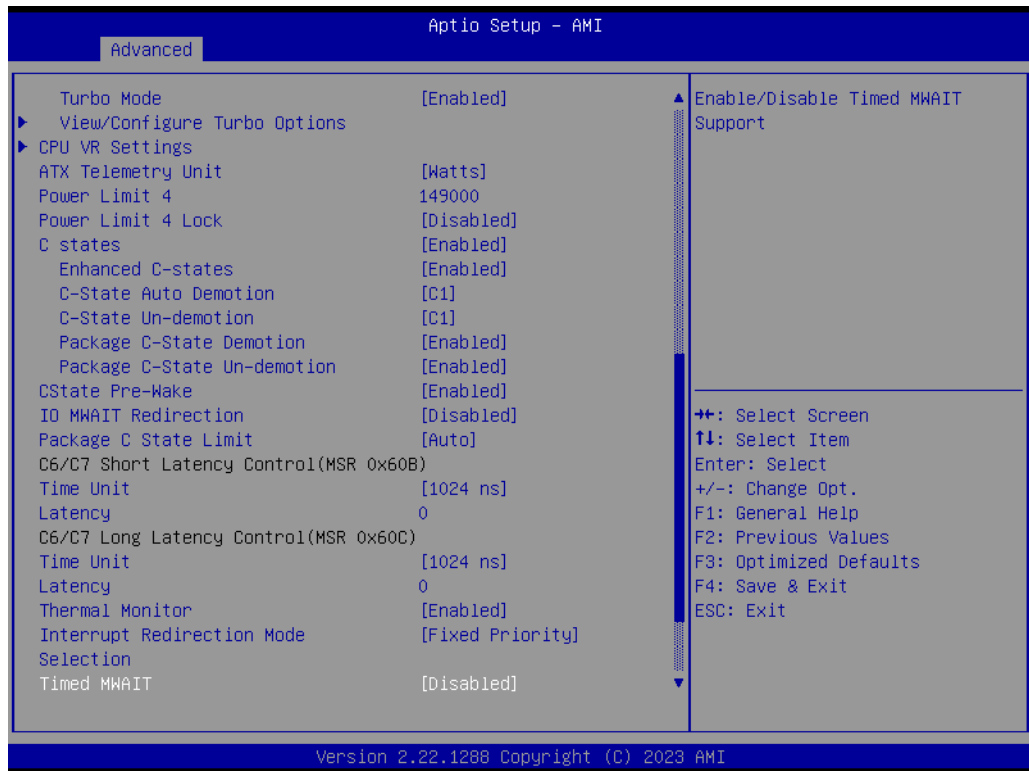

Figure 3.9

Current Turbo Settings

Advanced → Power & Performance → CPU - Power Management Control → View/Configure Turbo Option

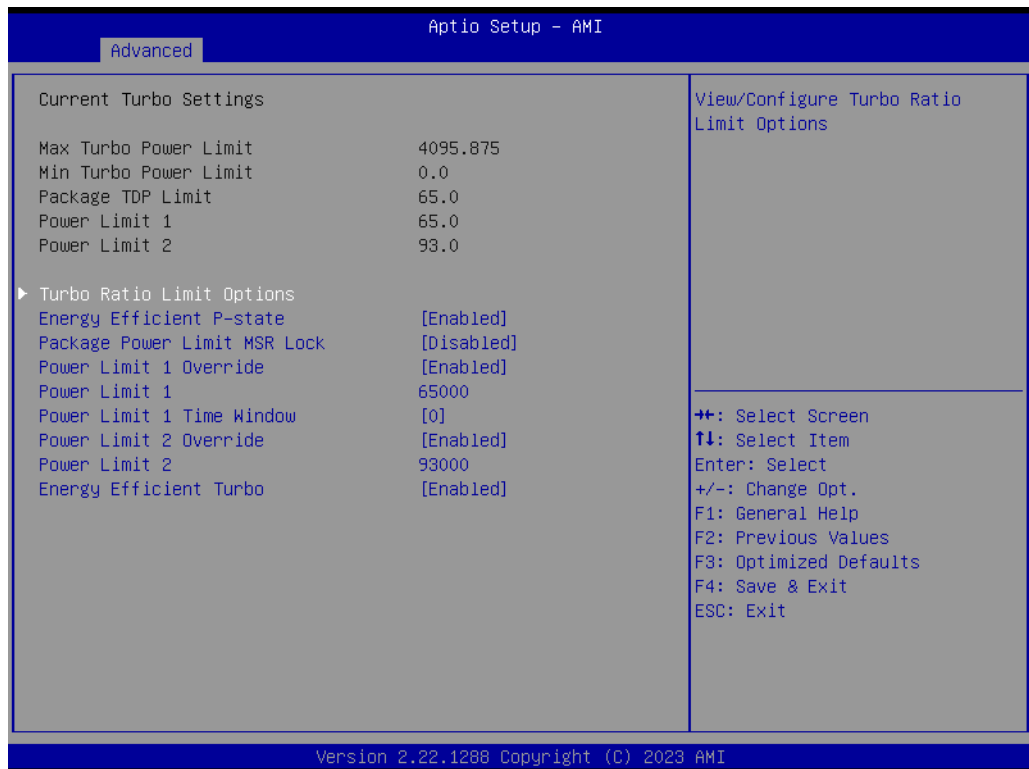

Figure 3.10

Turbo Ratio Limit Options

Advanced → Power & Performance → CPU – Power Management Control → View/
Configure Turbo Option → Turbo Ratio Limit Options

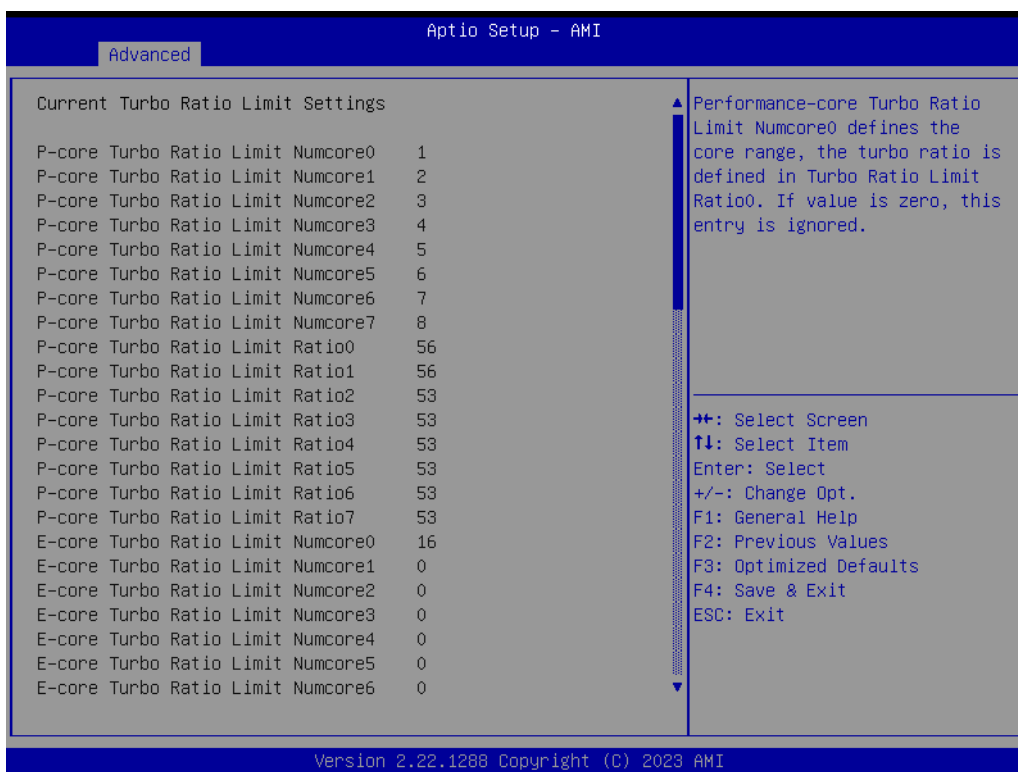

Figure 3.11

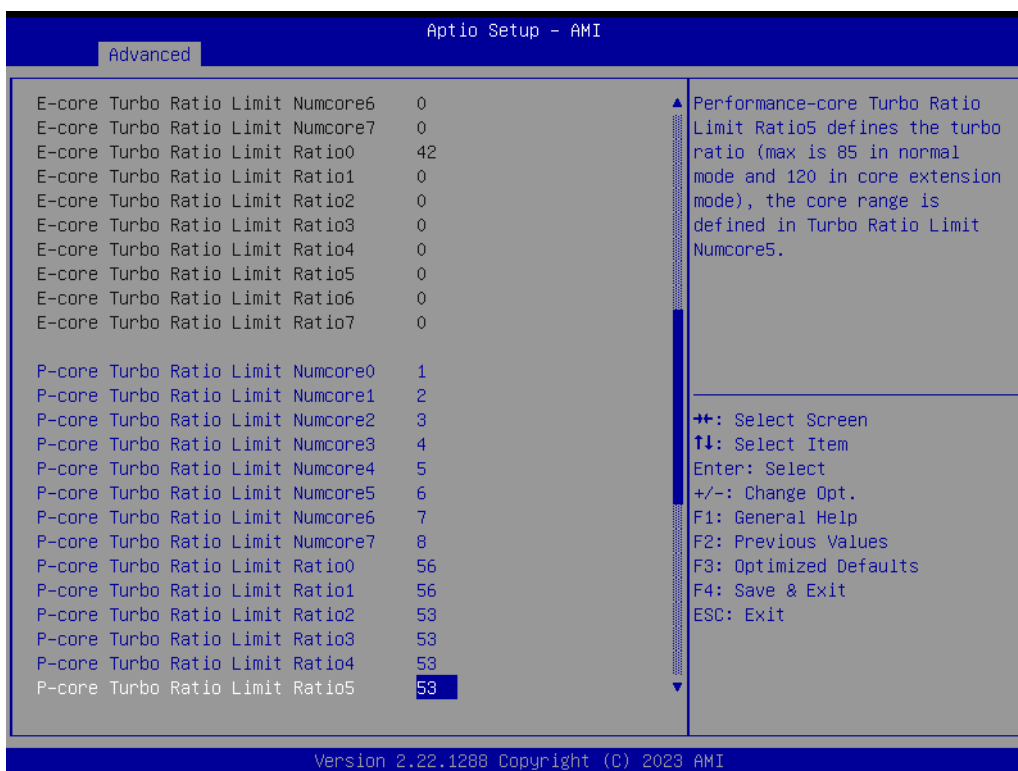

Figure 3.12

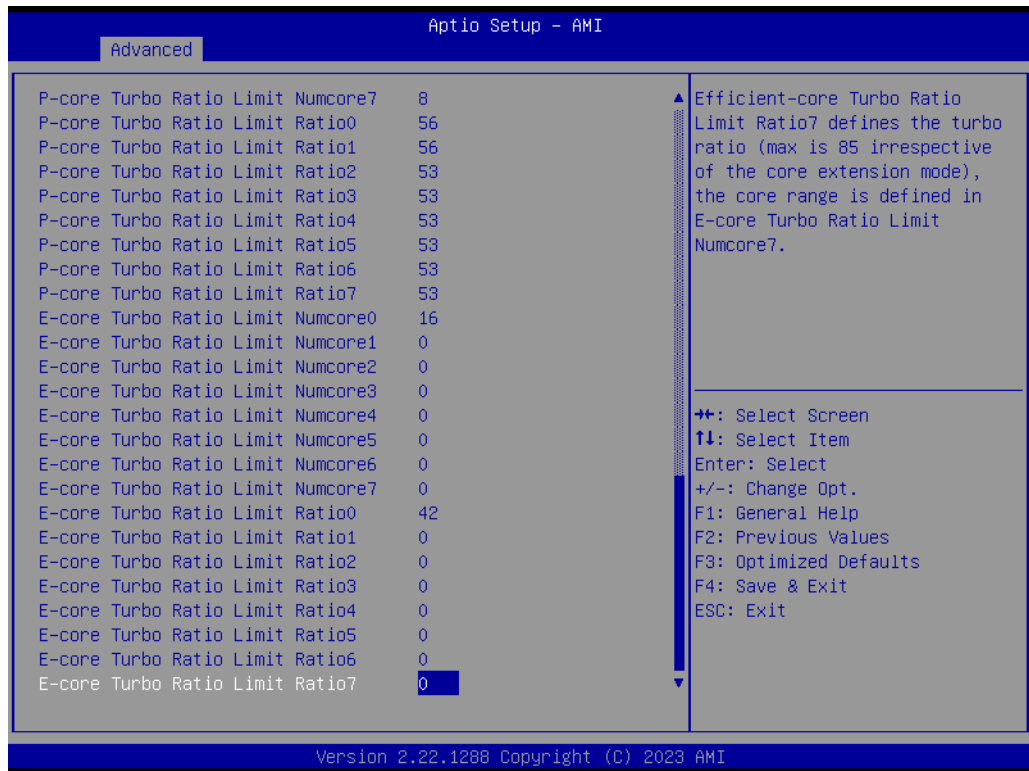

Figure 3.13

CPU VR Settings

Advanced → Power & Performance → CPU - Power Management Control → CPU VR Settings

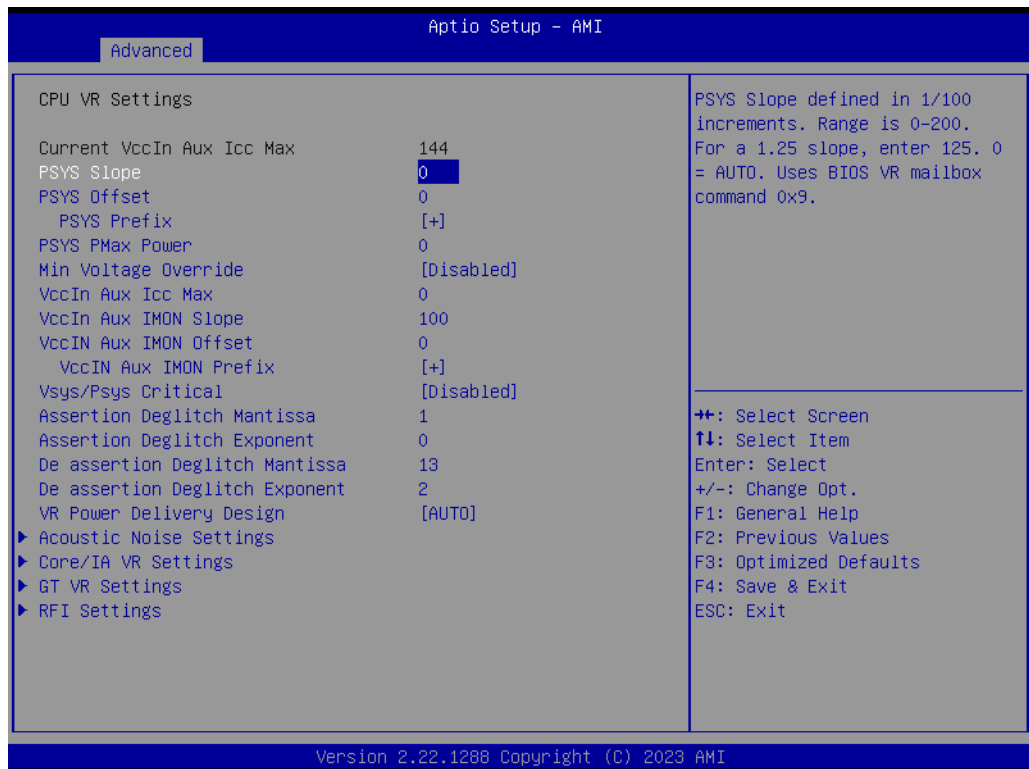

Figure 3.14

Acoustic Noise Settings

Advanced → Power & Performance → CPU - Power Management Control → CPU VR Settings → Acoustic Noise Settings



Figure 3.15

Core/IA VR Settings

Advanced → Power & Performance → CPU - Power Management Control → CPU VR Settings → Core/IA Settings

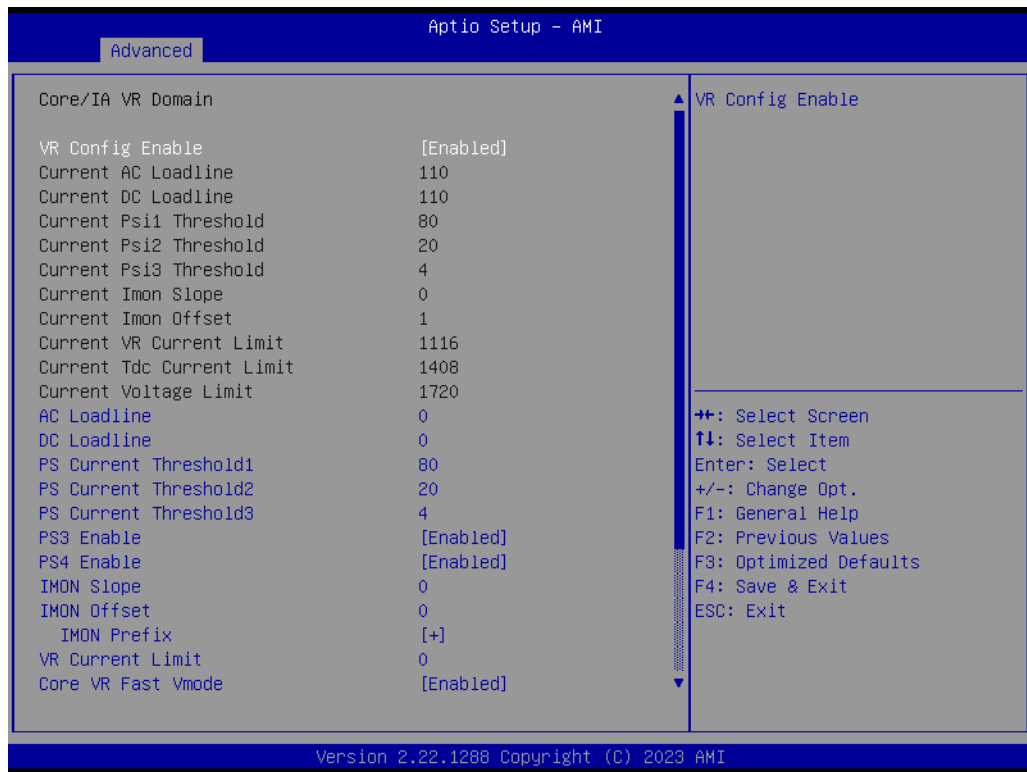

Figure 3.16

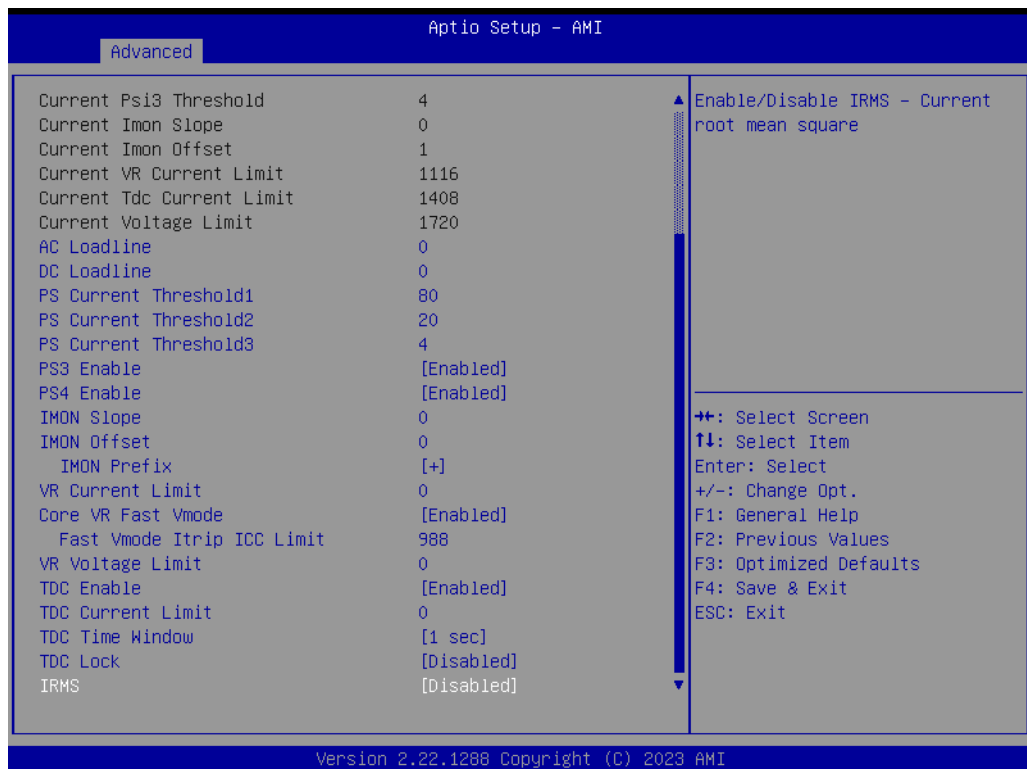

Figure 3.17

GT VR Settings

Advanced → Power & Performance → CPU - Power Management Control → CPU VR Settings → GT VR Settings

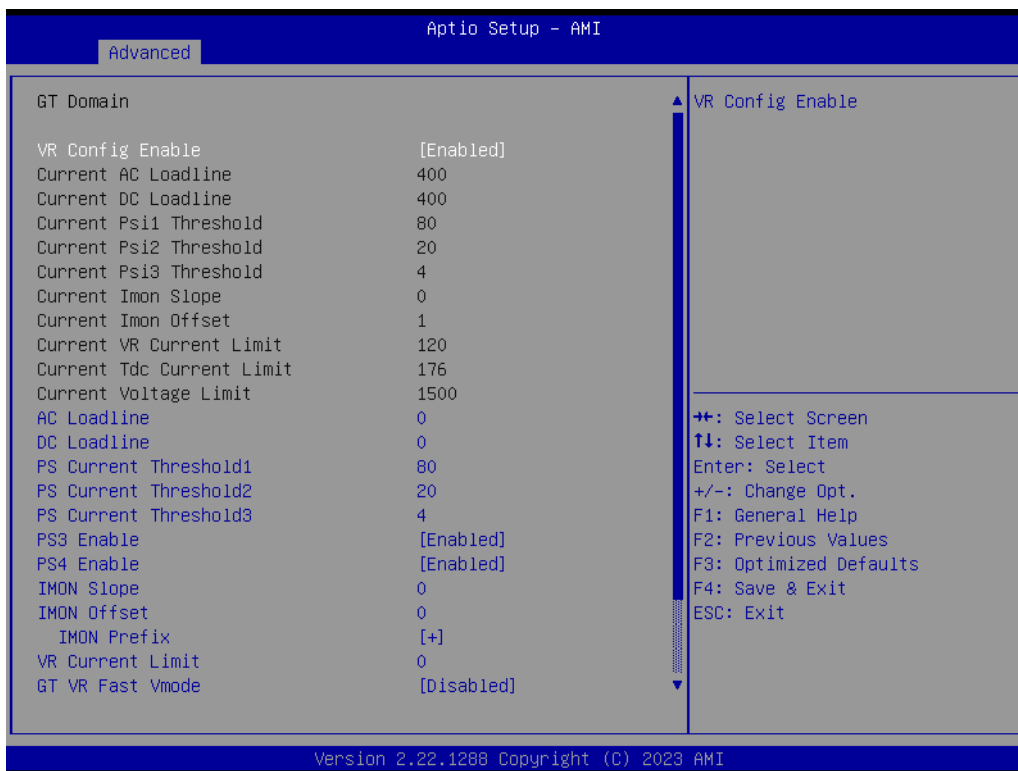

Figure 3.18

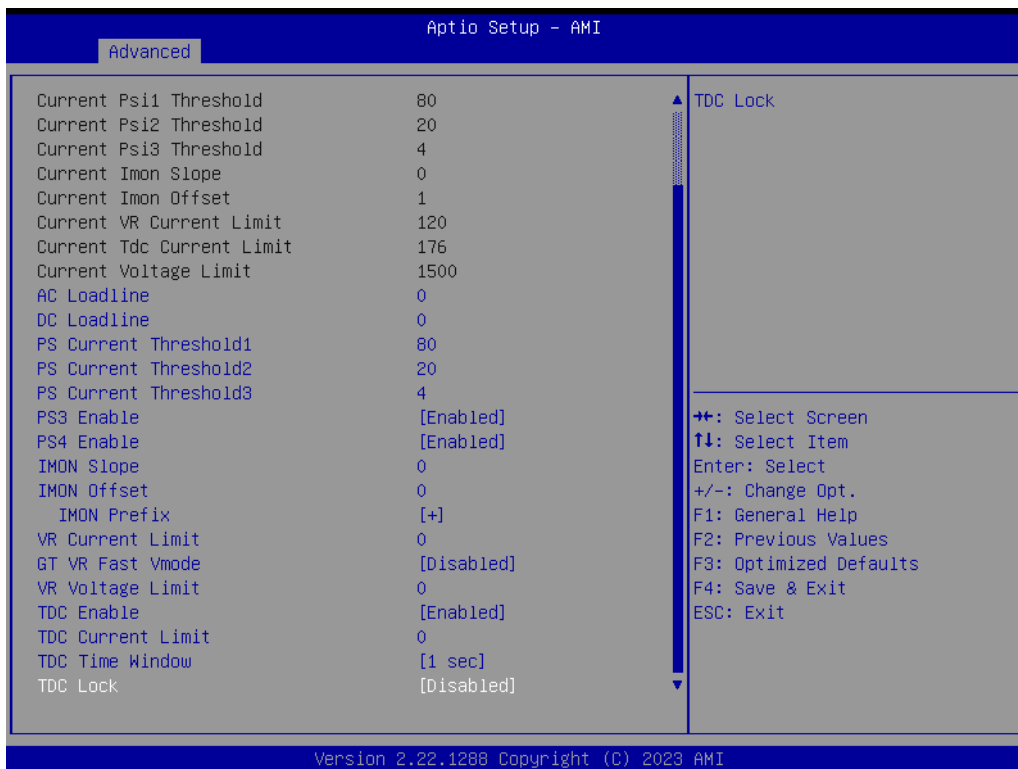

Figure 3.19

RFI Settings

Advanced → Power & Performance → CPU - Power Management Control → CPU VR Settings → RFI Settings

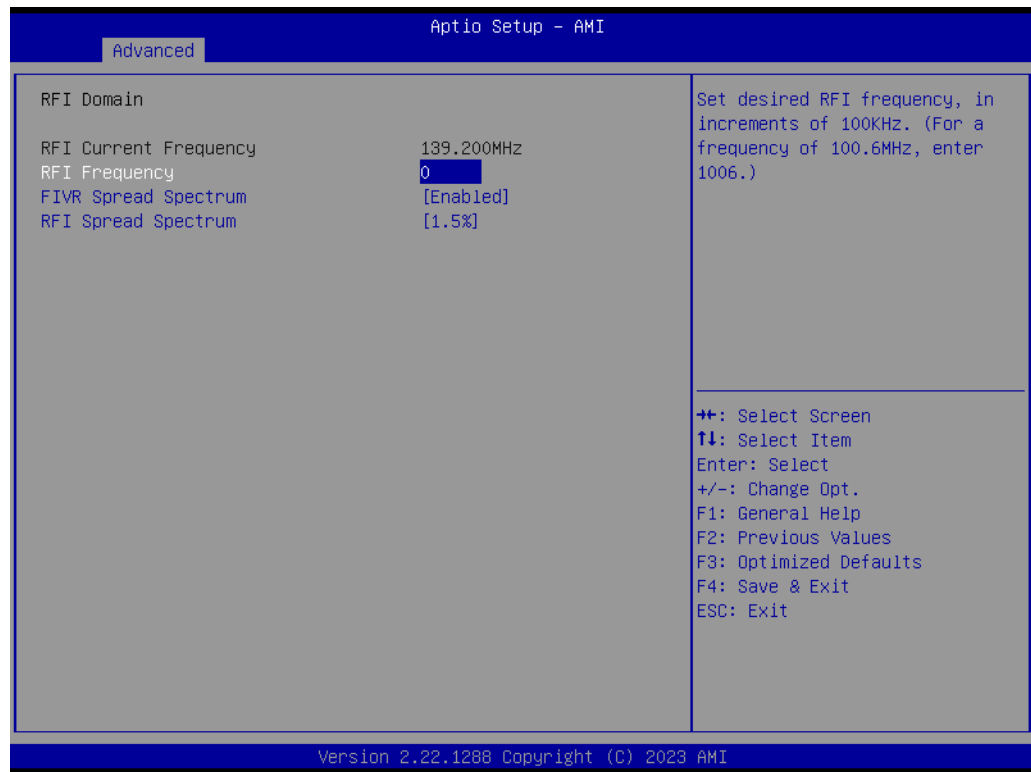

Figure 3.20

Custom P-State Table

Advanced → Power & Performance → CPU - Power Management Control → Custom P-State Table

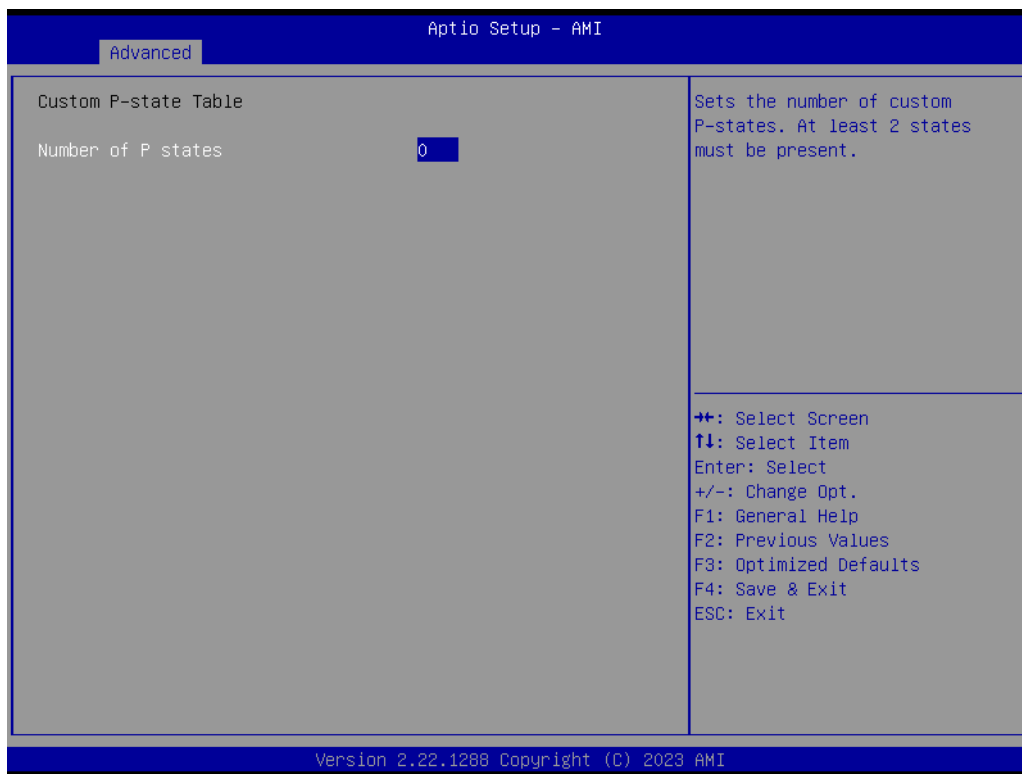

Figure 3.21

CPU Lock Configuration

Advanced → Power & Performance → CPU - Power Management Control → CPU Lock Configuration

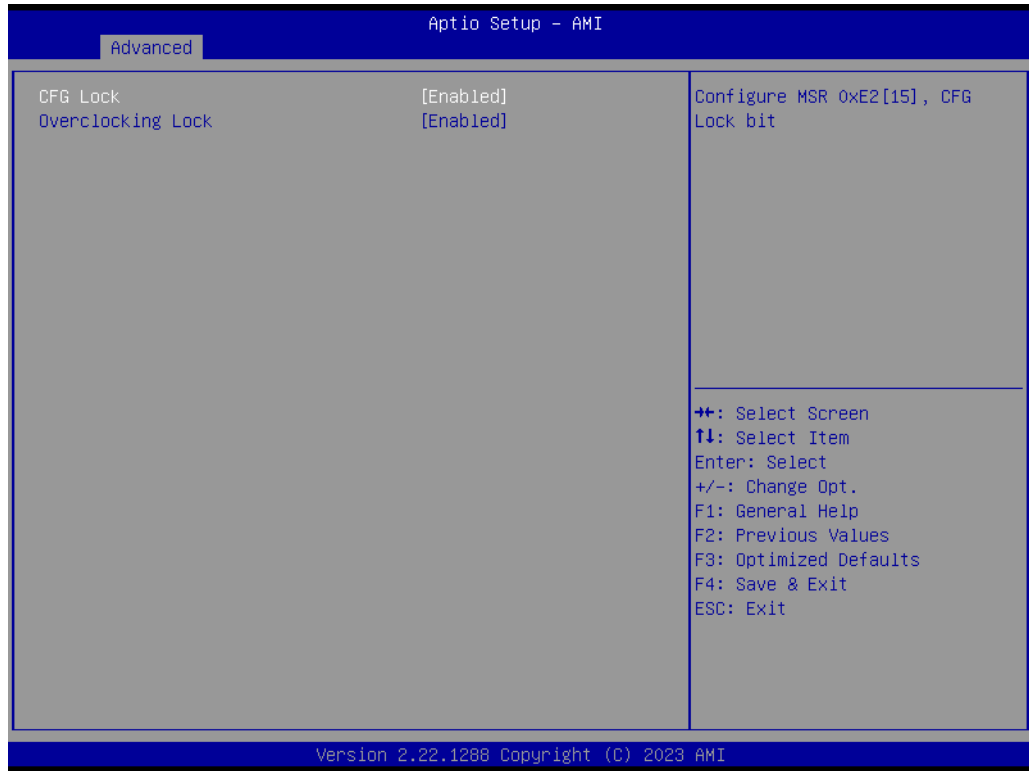

Figure 3.22

GT - Power Management Control

Advanced → Power & Performance → GT - Power Management Control

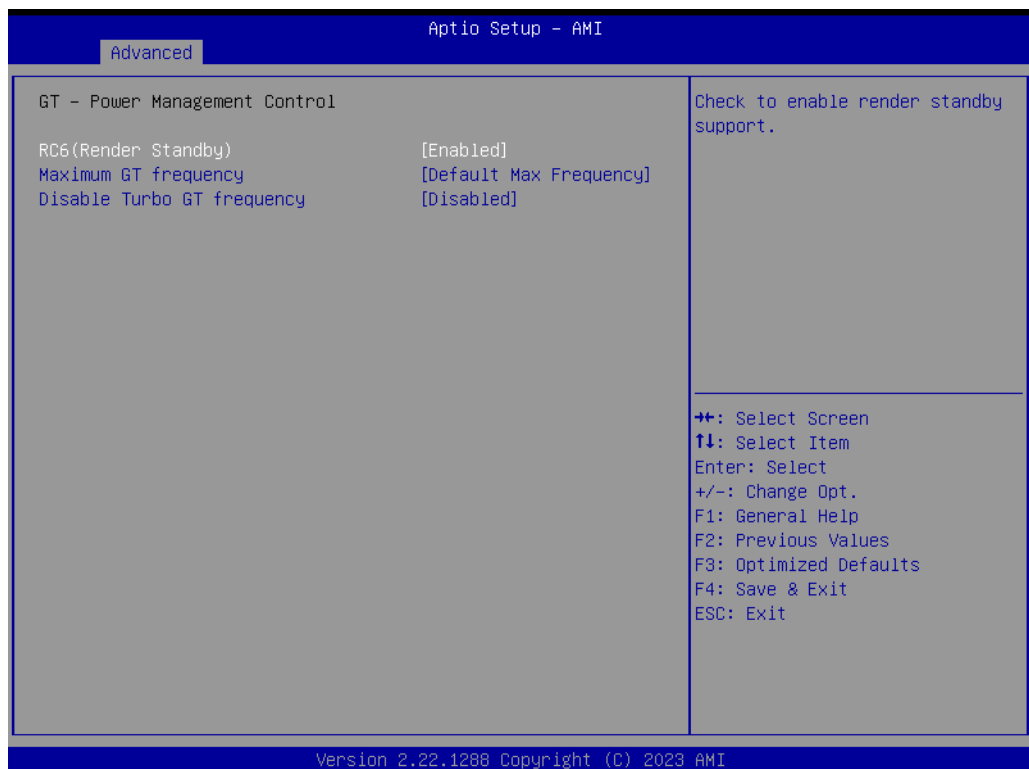

Figure 3.23

3.2.2.3 PCH-FW Configuration

Advanced → PCH-FW Configuration

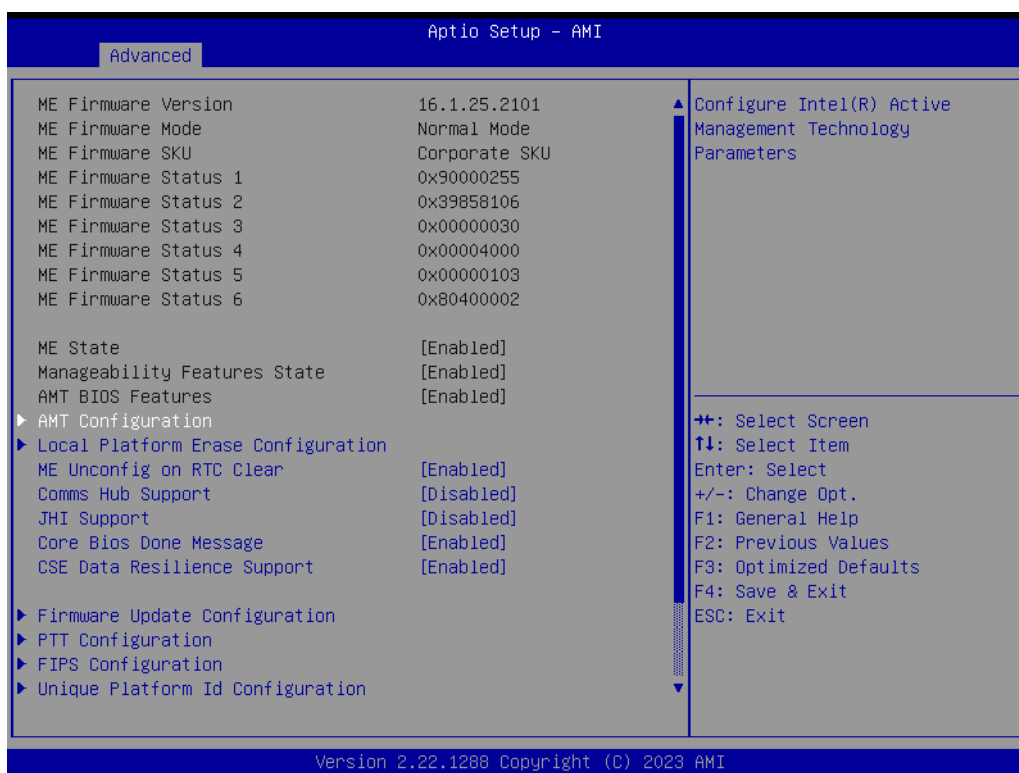

Figure 3.24

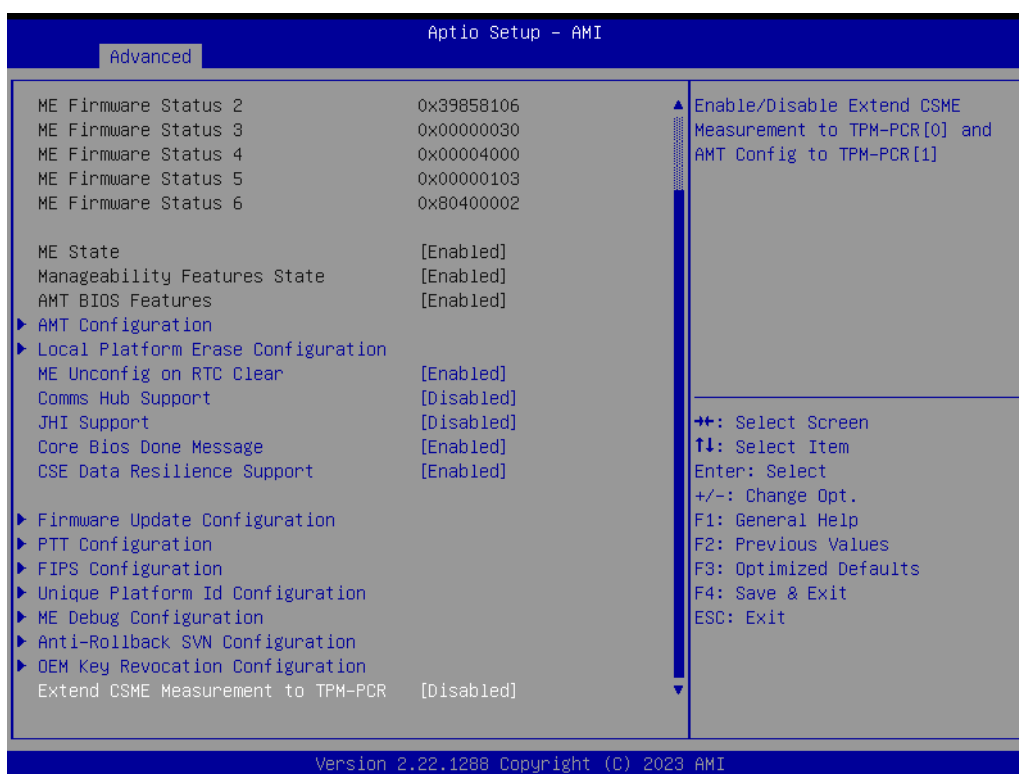

Figure 3.25

3.2.2.4 AMT Configuration

Advanced → PCH-FW Configuration → AMT Configuration

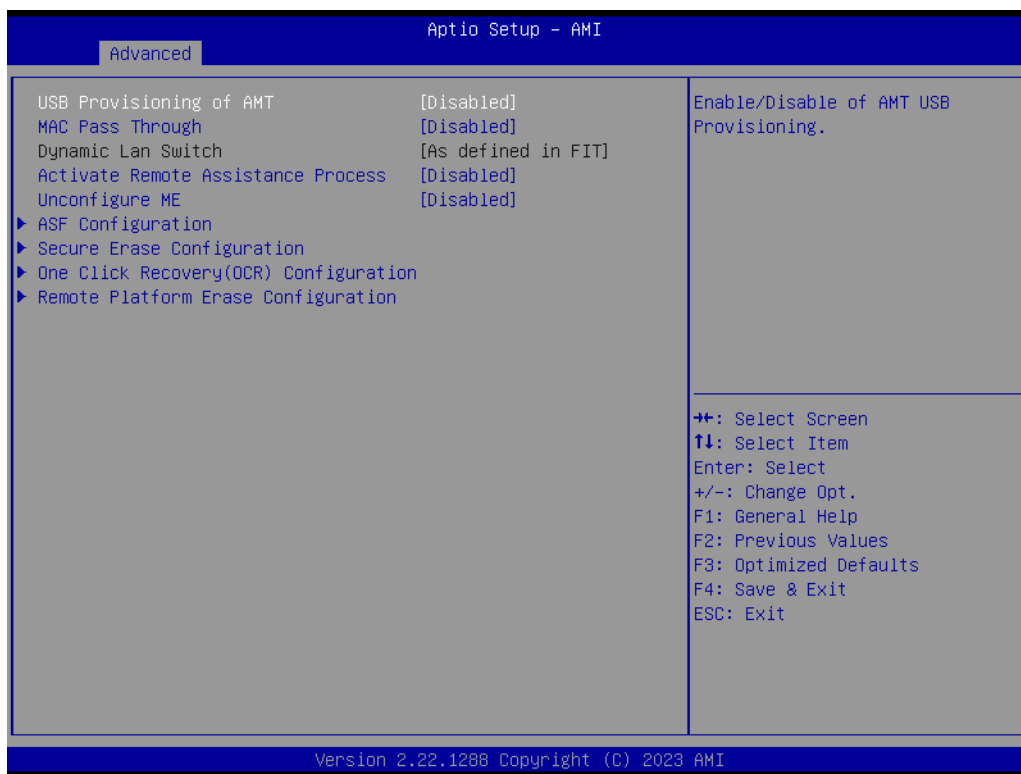

Figure 3.26

AMT Configuration

Advanced → PCH-FW Configuration → AMT Configuration → ASF Configuration

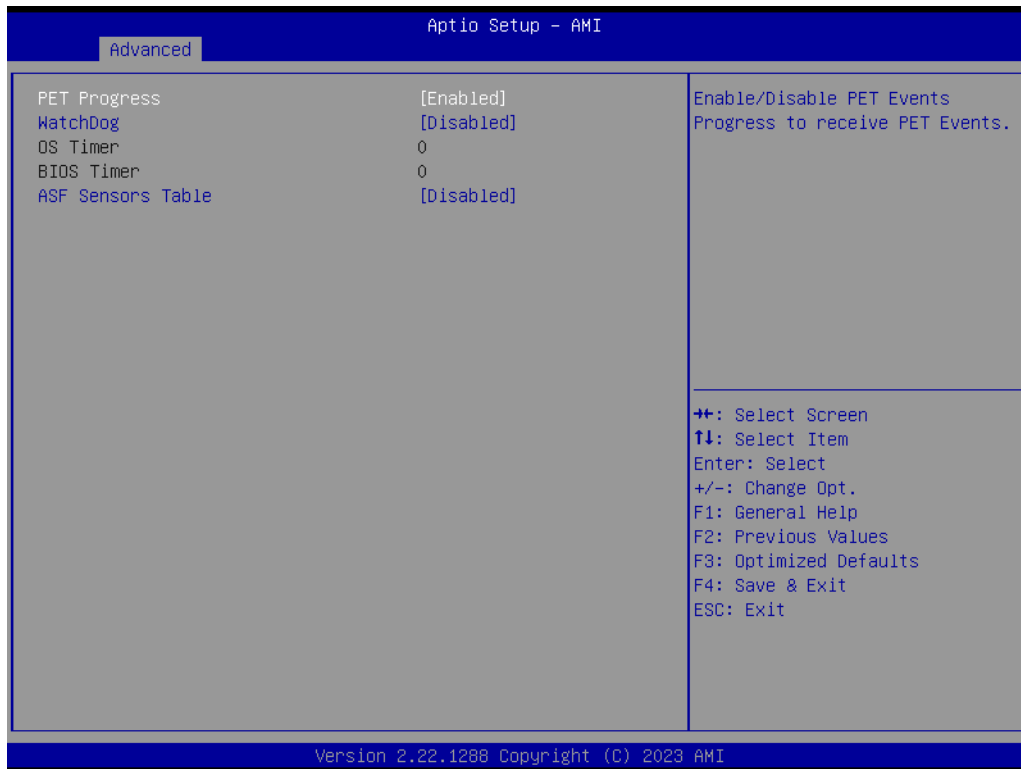

Figure 3.27

Secure Erase Configuration

Advanced → PCH-FW Configuration → AMT Configuration → Secure Erase Configuration



Figure 3.28

One Click Recovery (ORC) Configuration

Advanced → PCH-FW Configuration → AMT Configuration → One Click Recovery (ORC) Configuration

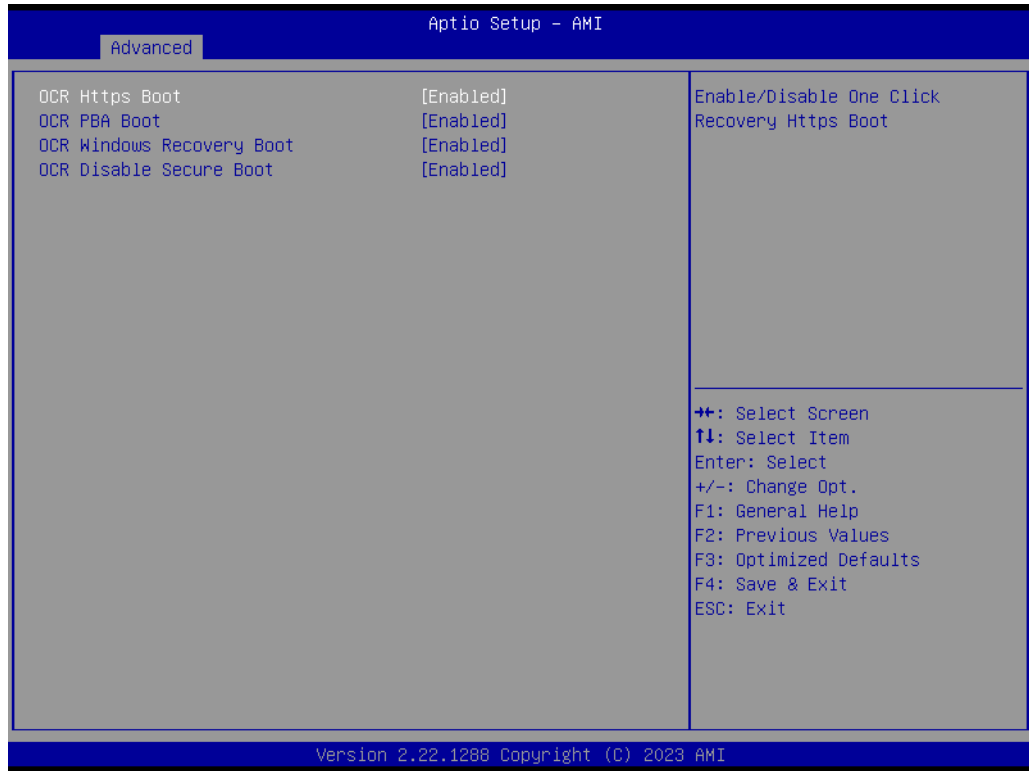

Figure 3.29

Firmware Update Configuration

Advanced → PCH-FW Configuration → Firmware Update Configuration



Figure 3.30

PTT Configuration

Advanced → PCH-FW Configuration → PTT Configuration

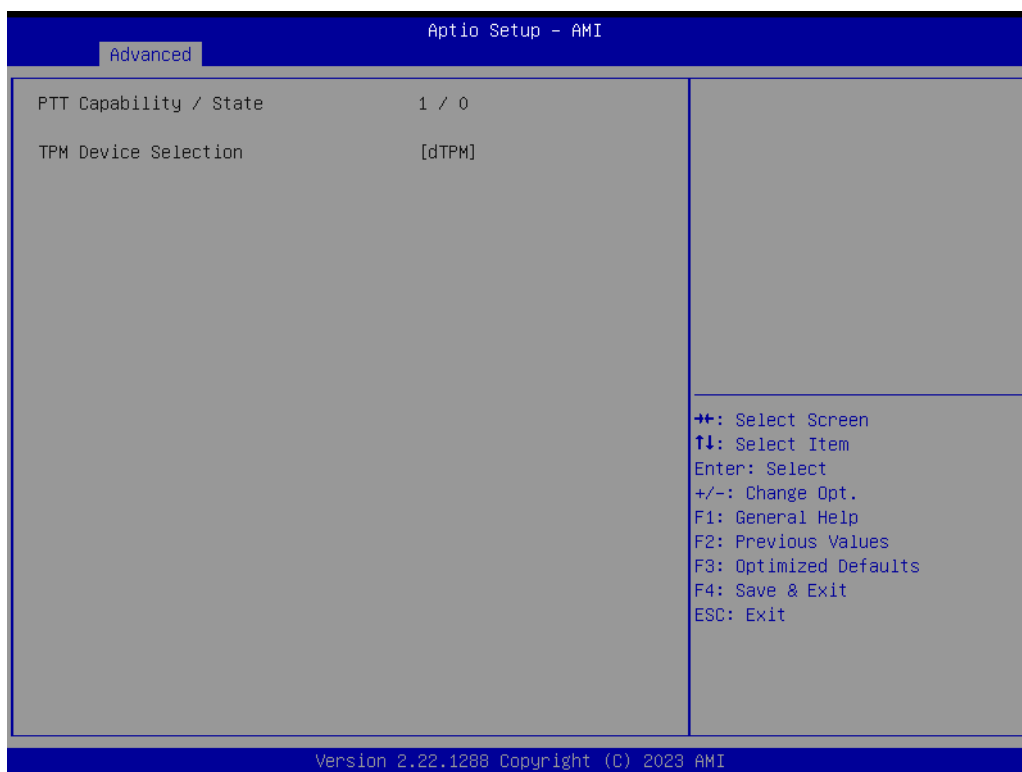

Figure 3.31

FIPS Configuration

Advanced → PCH-FW Configuration → FIPS Configuration

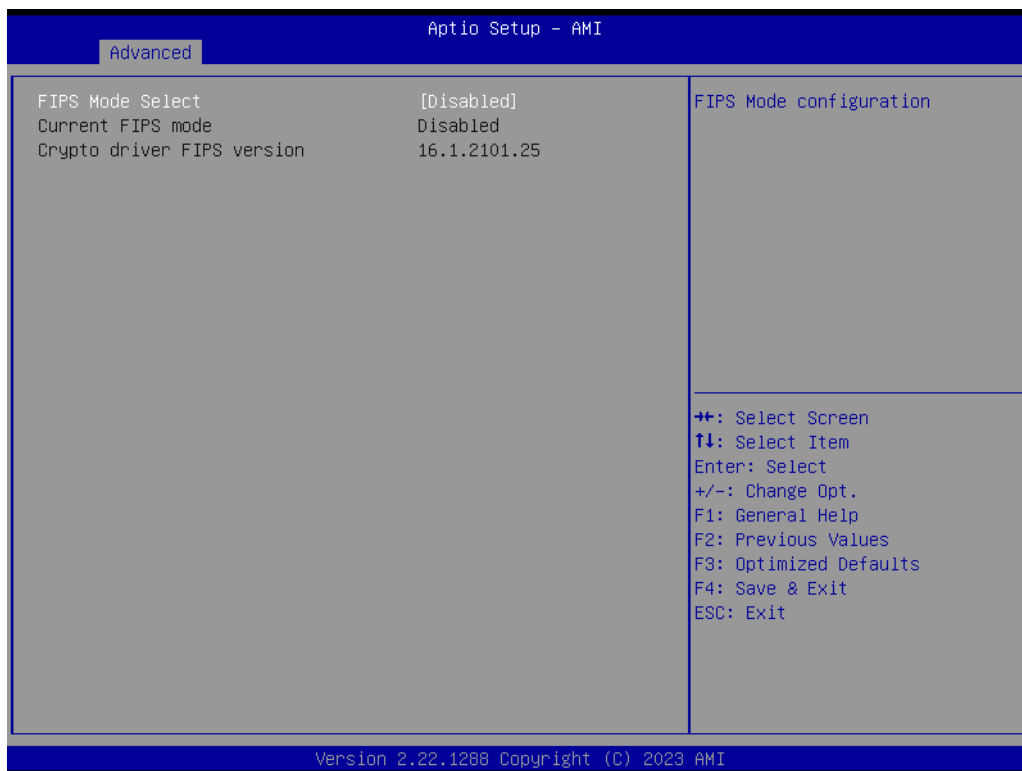

Figure 3.32

Unique Platform Id Configuration

Advanced → PCH-FW Configuration → Unique Platform Id Configuration

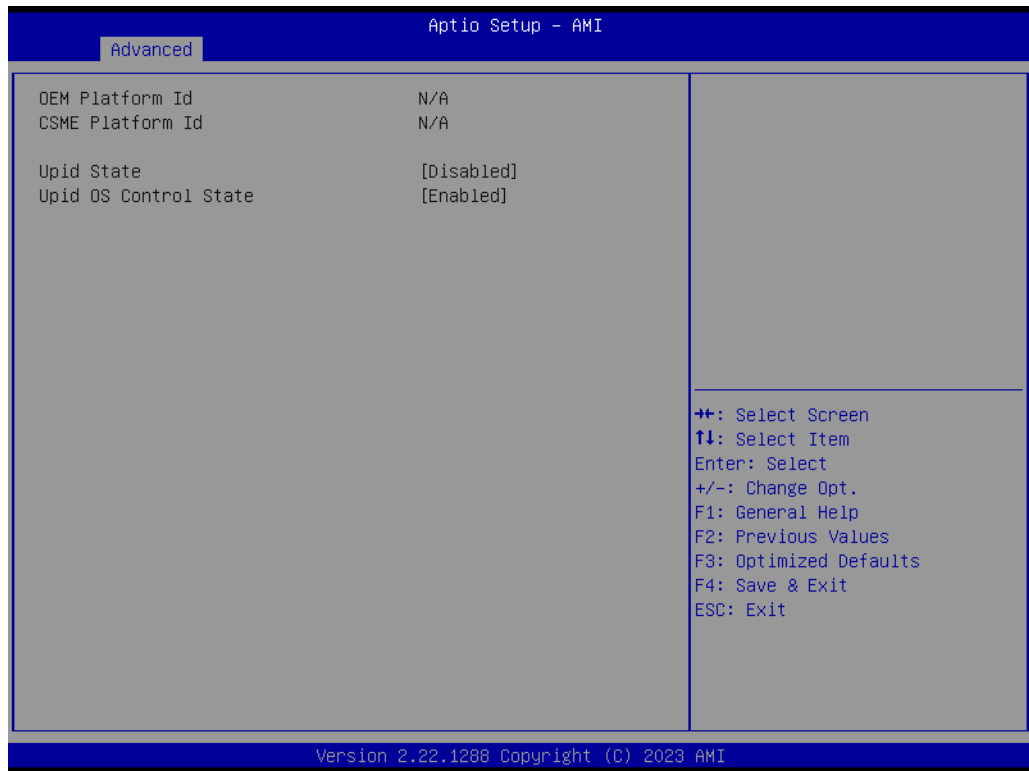

Figure 3.33

ME Debug Configuration

Advanced → PCH-FW Configuration → ME Debug Configuration

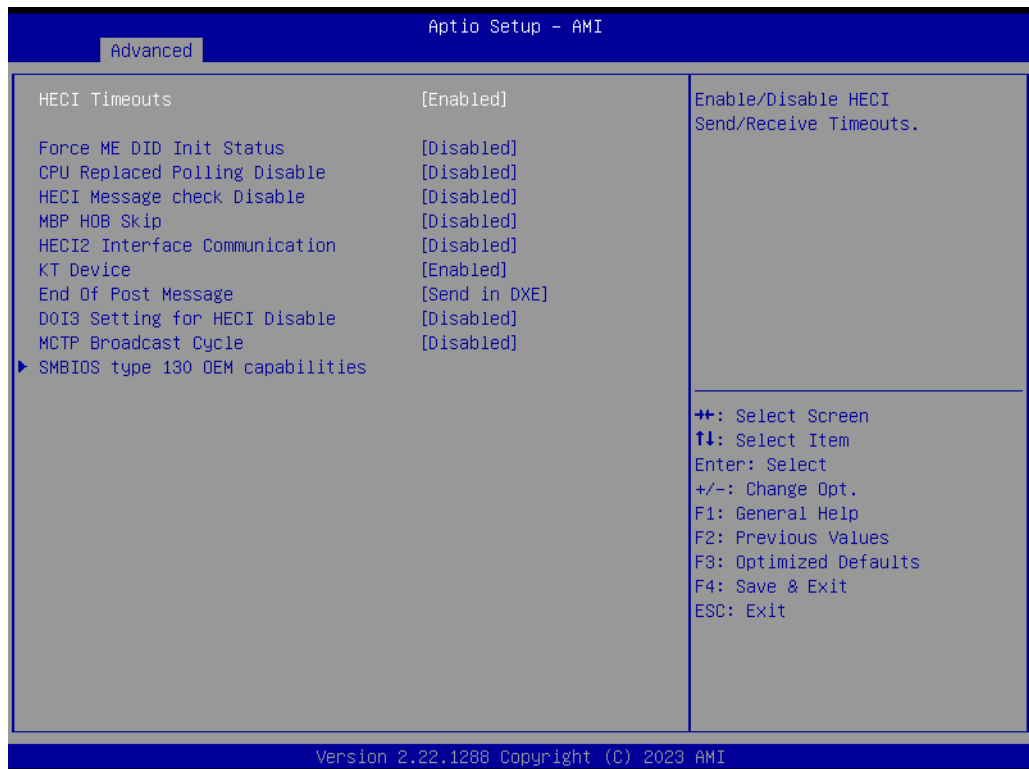

Figure 3.34

SMBIOS Type 130 OEM Capabilities

Advanced → PCH-FW Configuration → ME debug Configuration → SMBIOS Type 130 OEM Capabilities



Figure 3.35

Anti-Rollback SVN Configuration

Advanced → PCH-FW Configuration → Anti-Rollback SVN Configuration



Figure 3.36

OEM Key Revocation Configuration

Advanced → PCH-FW Configuration → OEM Key Revocation Configuration

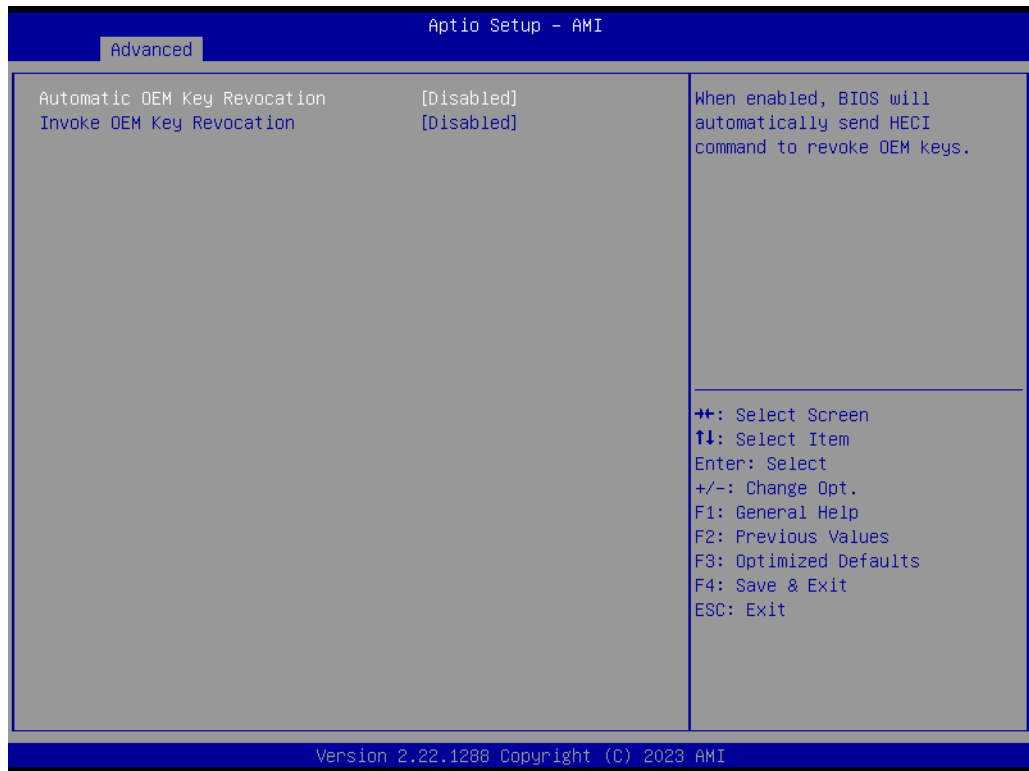

Figure 3.37

3.2.2.5 Trusted Computing Settings

Advanced → Trusted Computing

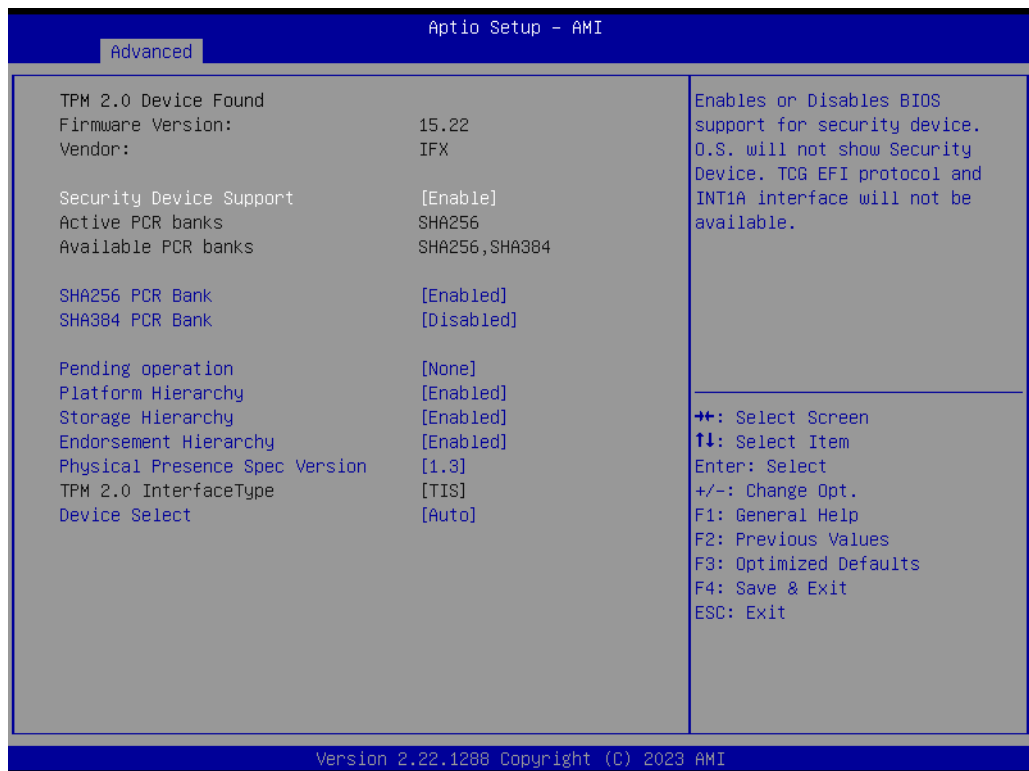

Figure 3.38

3.2.2.6 ACPI Settings

Advanced → ACPI Settings

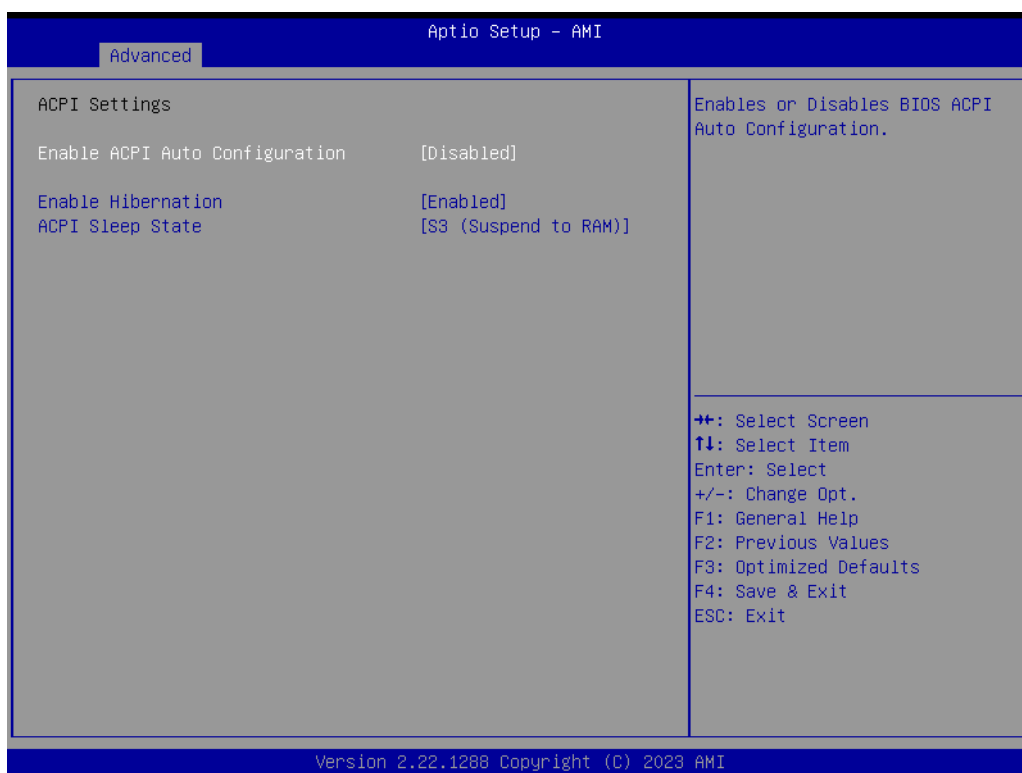

Figure 3.39

3.2.2.7 NCT6126D Super IO Configuration

Advanced → NCT6126D Super IO Configuration



Figure 3.40

Serial Port 1 Configuration

Advanced → NCT6126D Super IO Configuration → Serial Port 1 Configuration



Figure 3.41

Serial Port 2 Configuration

Advanced → NCT6126D Super IO Configuration → Serial Port 2 Configuration



Figure 3.42

3.2.2.8 NCT6126D HW Monitor

Advanced → NCT6126D HW Monitor

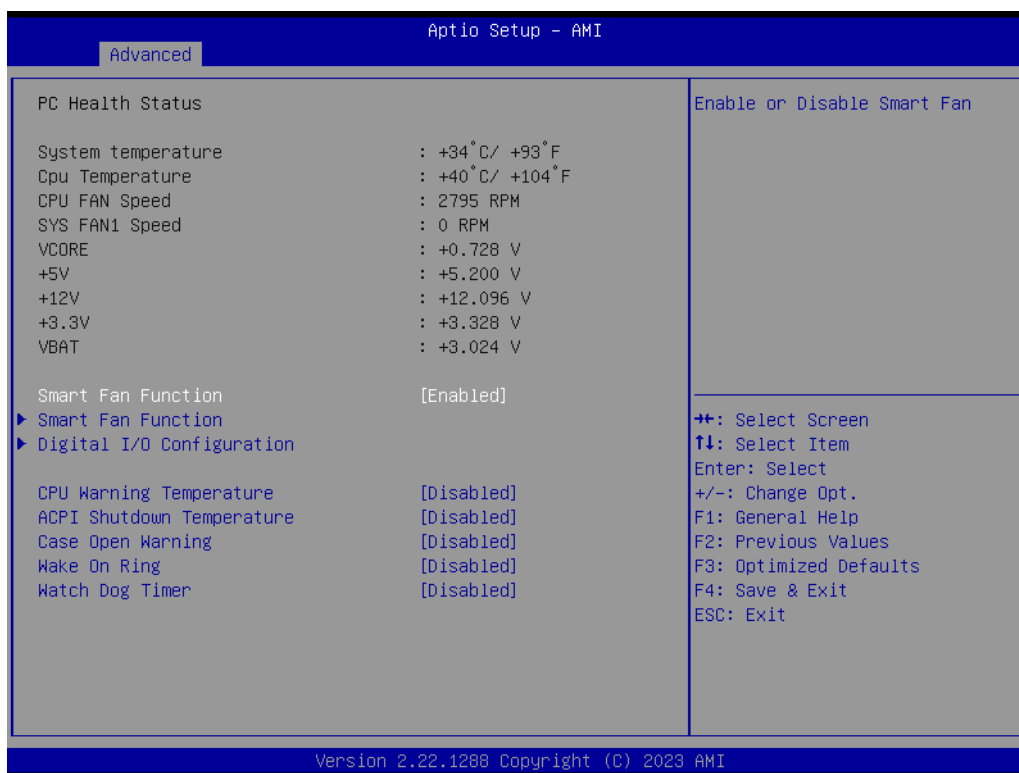

Figure 3.43

Smart Fan Function

Advanced → NCT6126D HW Monitor → Smart Fan Function

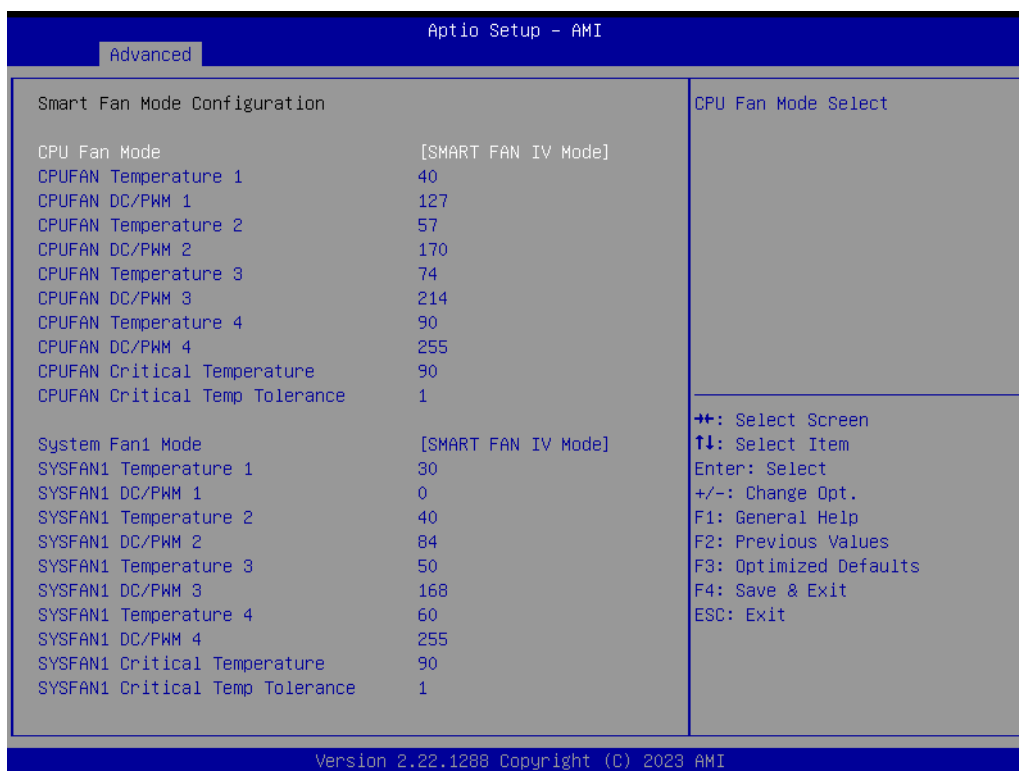

Figure 3.44

Digital I/O Configuration

Advanced → NCT6126D HW Monitor → Digital I/O Configuration

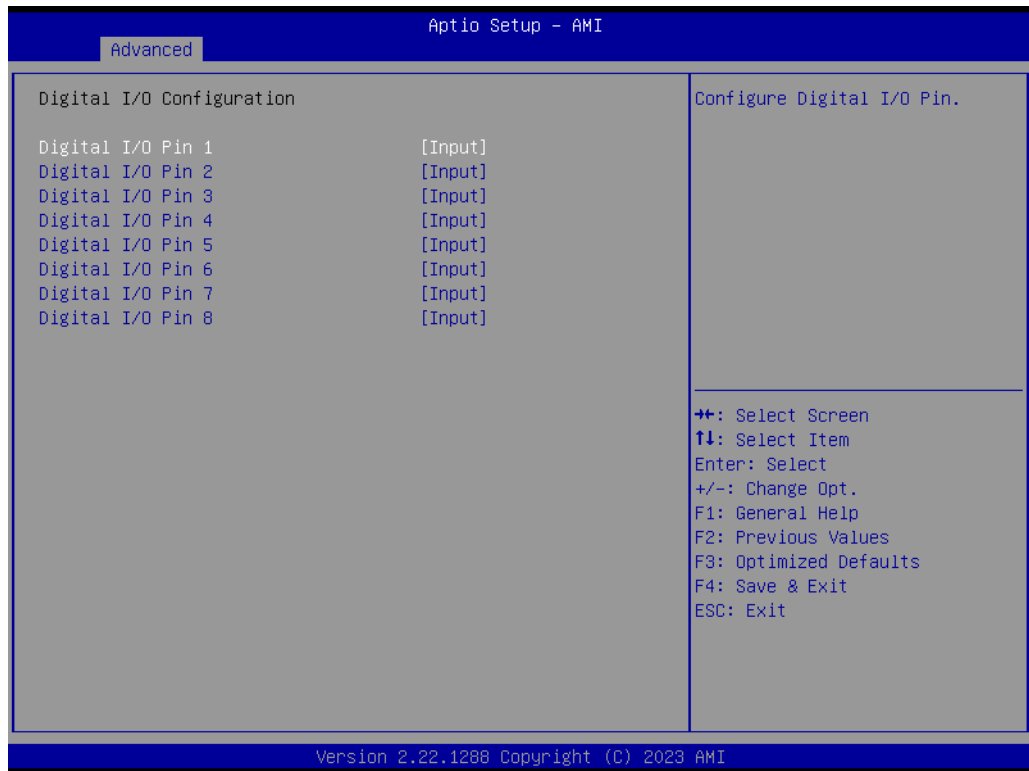

Figure 3.45

3.2.2.9 S5 RTC Wake Settings

Advanced → S5 RTC Wake Settings



Figure 3.46

3.2.2.10 Serial Port Console Redirection

Advanced → Serial Port Console Redirection



Figure 3.47

Legacy Console Redirection Settings

Advanced → Serial Port Console Redirection → Legacy Console Redirection Settings



Figure 3.48

3.2.2.11 Intel® TXT Information

Advanced → Intel TXT Information

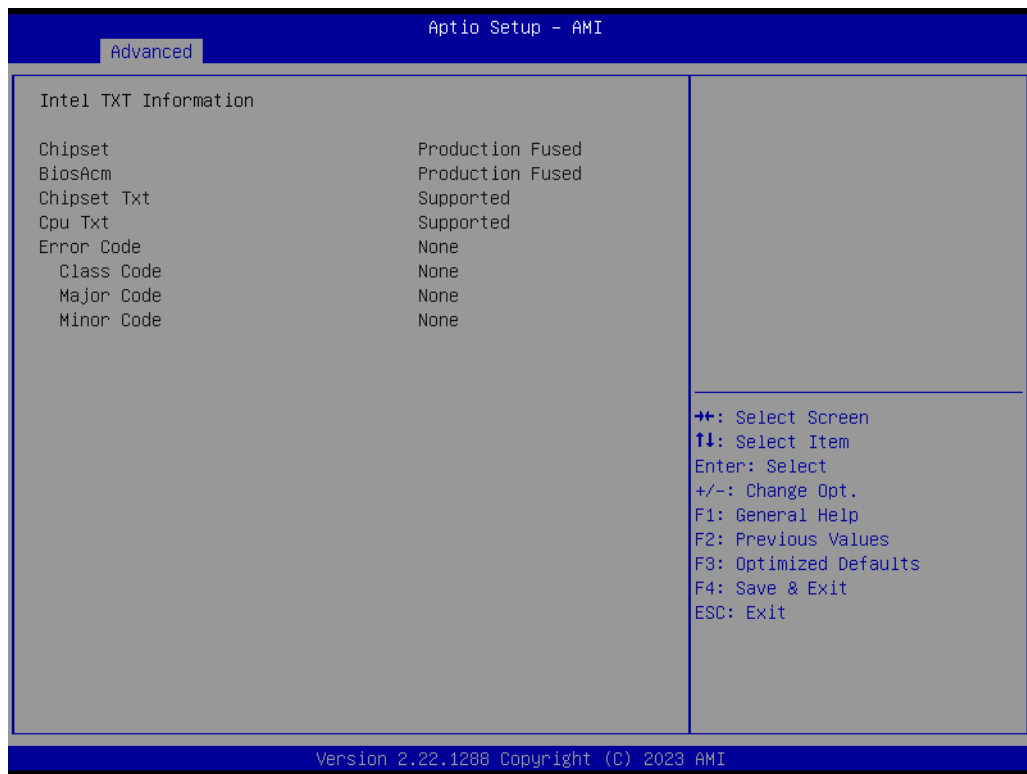

Figure 3.49

3.2.2.12 USB Configuration

Advanced → USB Configuration

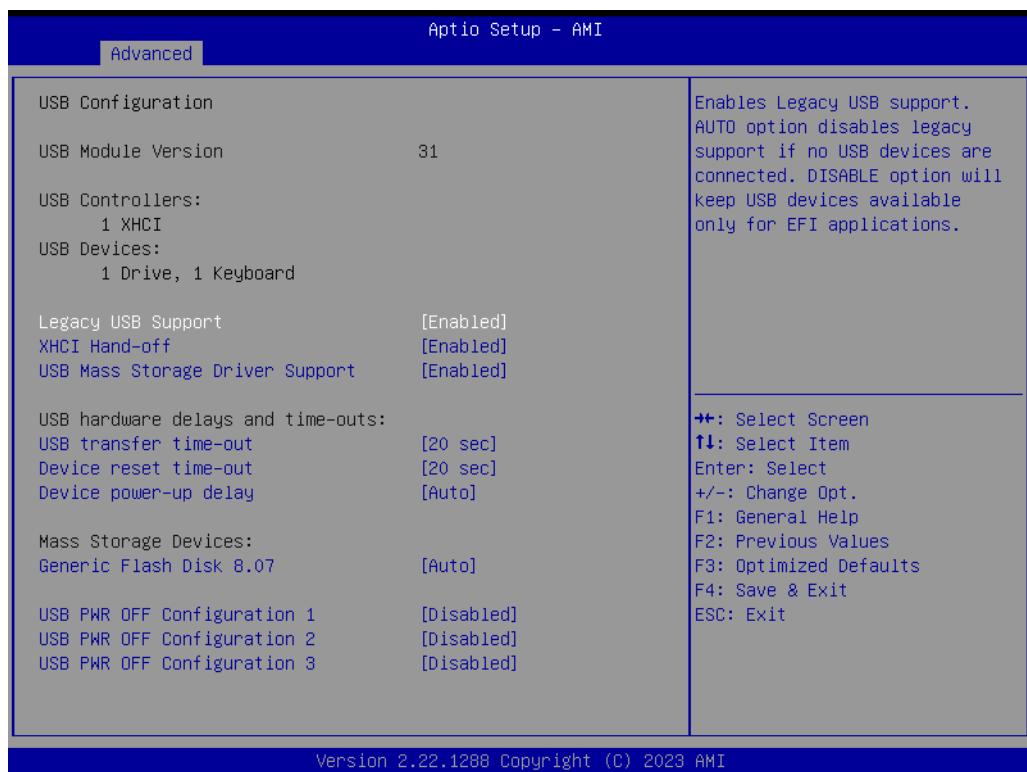

Figure 3.50

3.2.2.13 Network Stack Configuration

Advanced → Network Stack Configuration

**Figure 3.51****3.2.2.14 CSM Configuration**

Advanced → CSM Configuration

**Figure 3.52**

3.2.2.15 NVMe Configuration

Advanced → NVMe Configuration



Figure 3.53

3.2.2.16 Tls Auth Configuration

Advanced → Tls Auth Configuration



Figure 3.54

3.2.2.17 Driver Health

Advanced → Driver Health

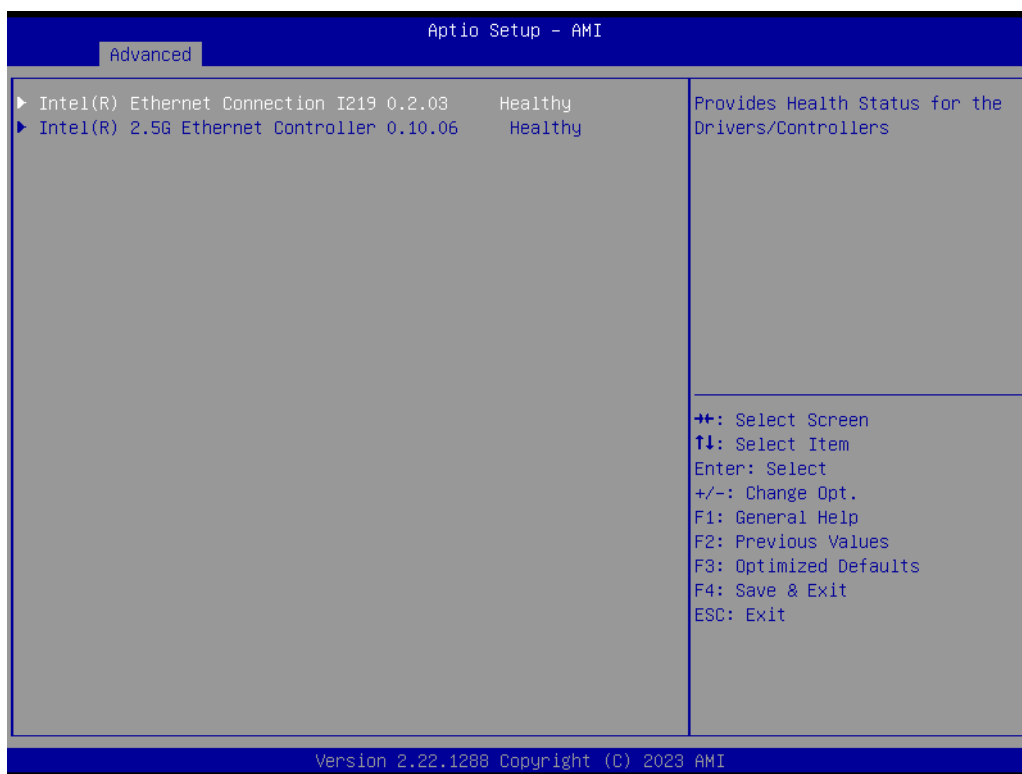

Figure 3.55

3.2.3 Chipset Configuration Settings

Select the chipset tab from the BIOS setup screen to enter the Chipset Setup screen. Users can select any item in the left frame of the screen, such as PCI express Configuration, to go to the sub-menu for that item. Users can display a Chipset Setup option by highlighting it using the <Arrow> keys. All Chipset Setup options are described in this section. The Chipset Setup screens are shown below. The sub-menus are described on the following pages.

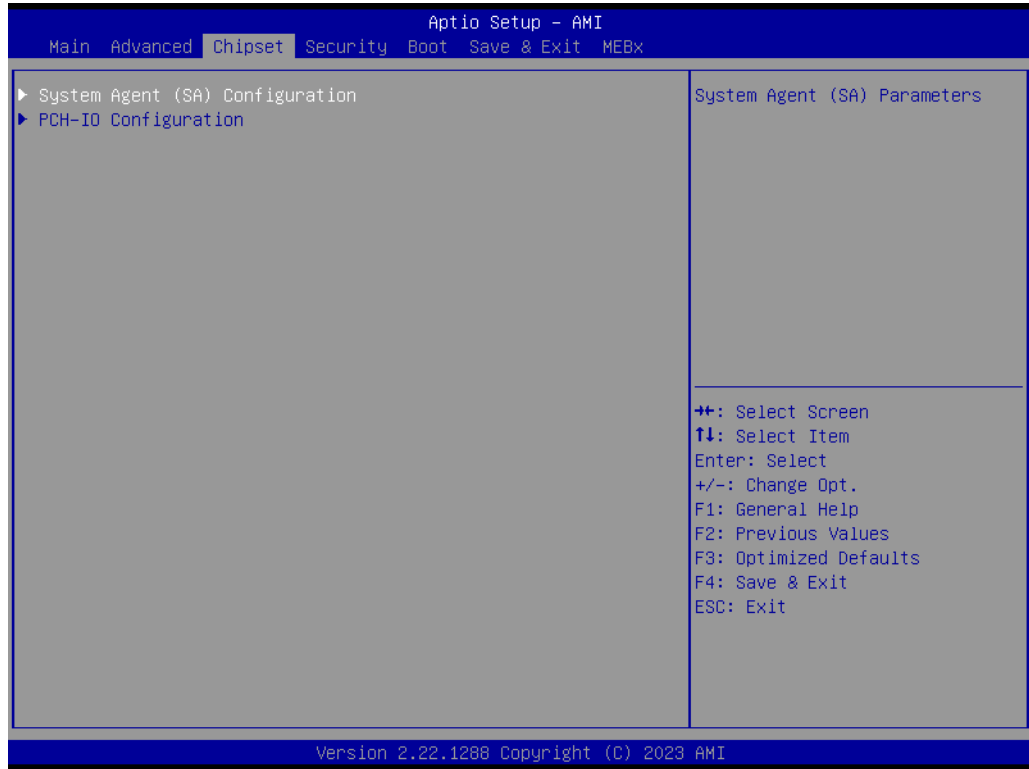

Figure 3.56

3.2.3.1 System Agent (SA) Configuration

Chipset → System Agent (SA) Configuration

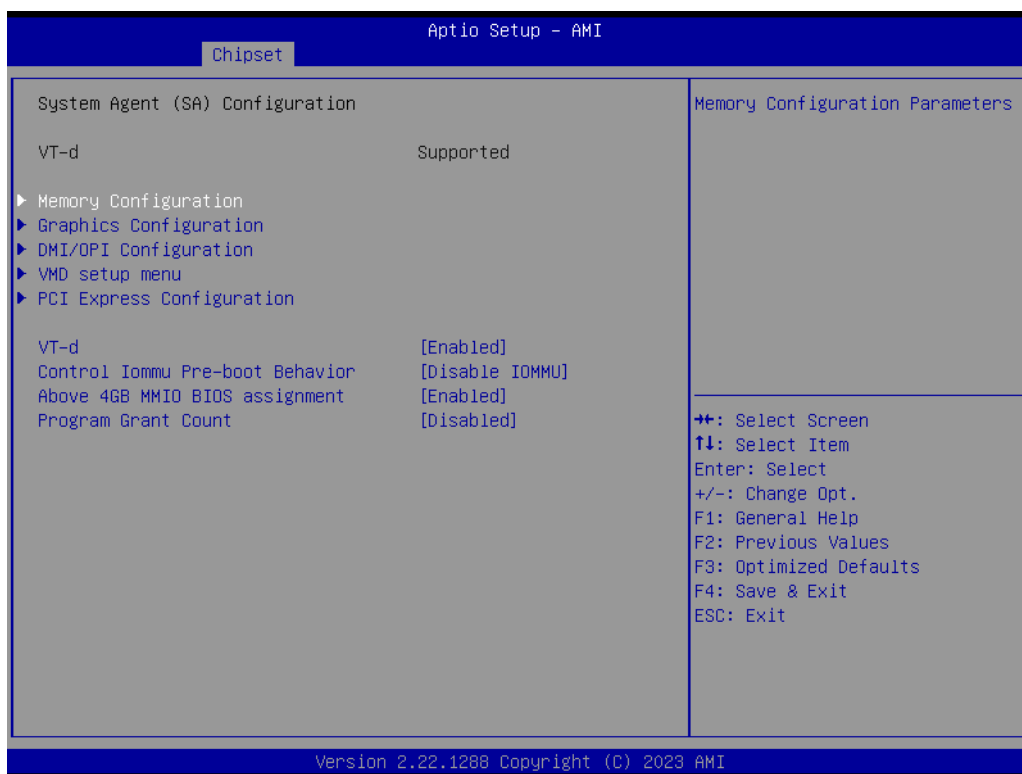

Figure 3.57

Memory Configuration

Chipset → System Agent (SA) Configuration → Memory Configuration

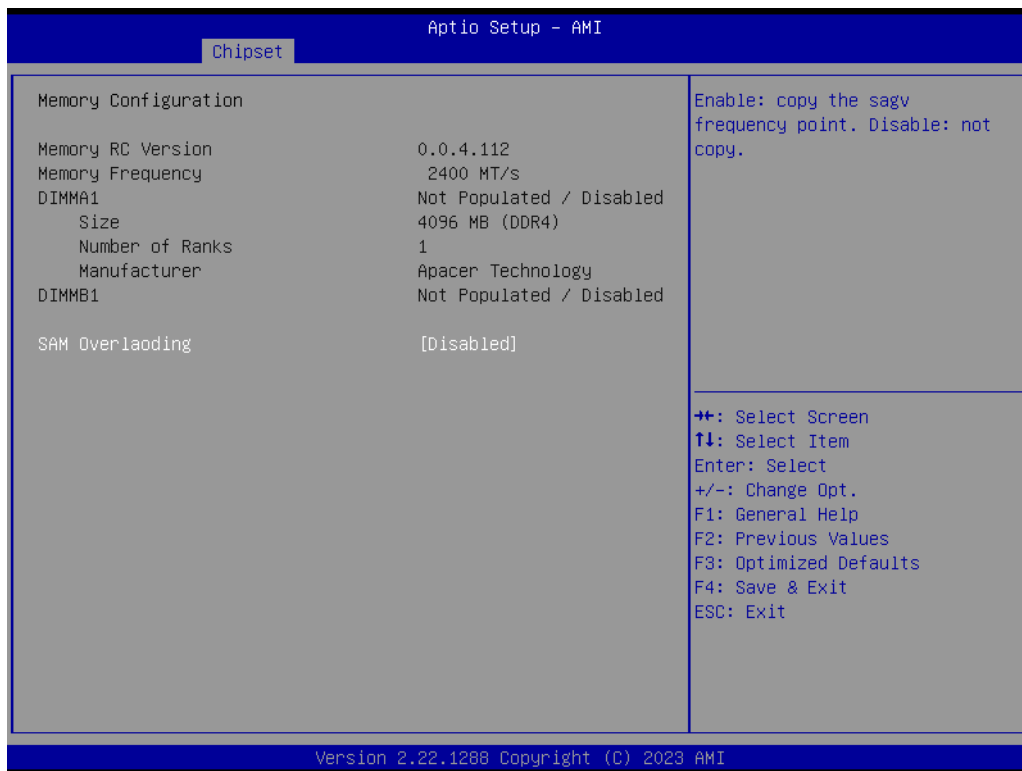

Figure 3.58

Graphics Configuration

Chipset → System Agent (SA) Configuration → Graphics Configuration

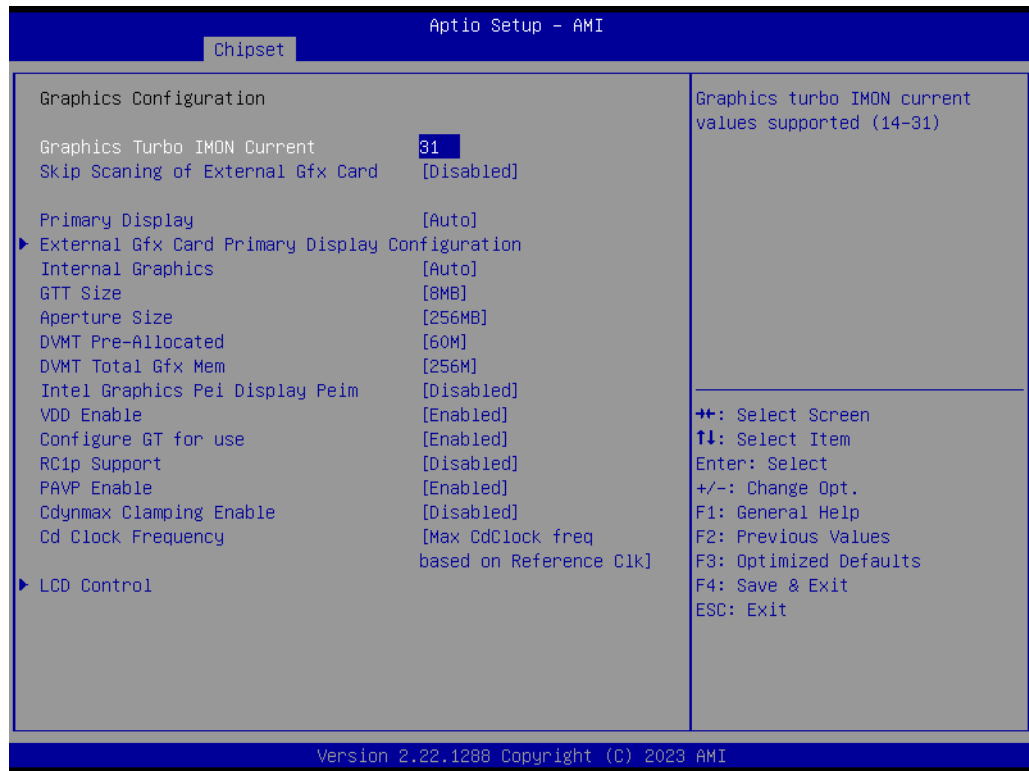

Figure 3.59

External Gfx Card Primary Display Configuration

Chipset → System Agent (SA) Configuration → Graphics Configuration → External Gfx Card Primary Display Configuration



Figure 3.60

LCD Control

Chipset → System Agent (SA) Configuration → Graphics Configuration → LCD Control

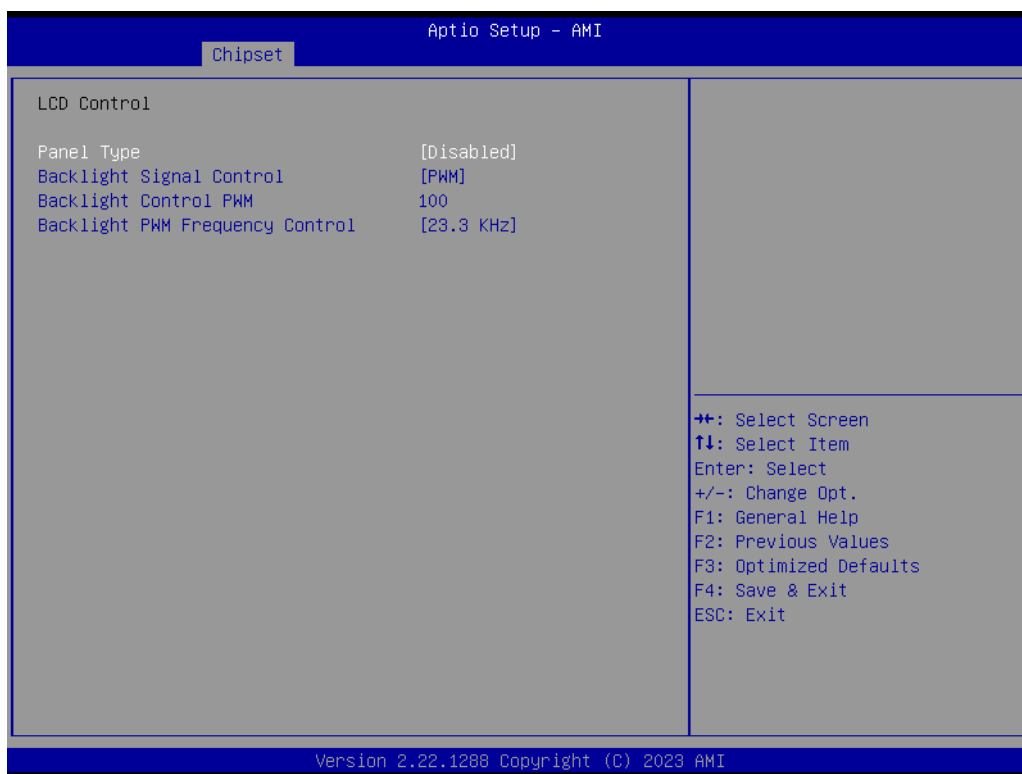

Figure 3.61

DMI/OPI Configuration

Chipset → System Agent (SA) Configuration → DMI/OPI Configuration

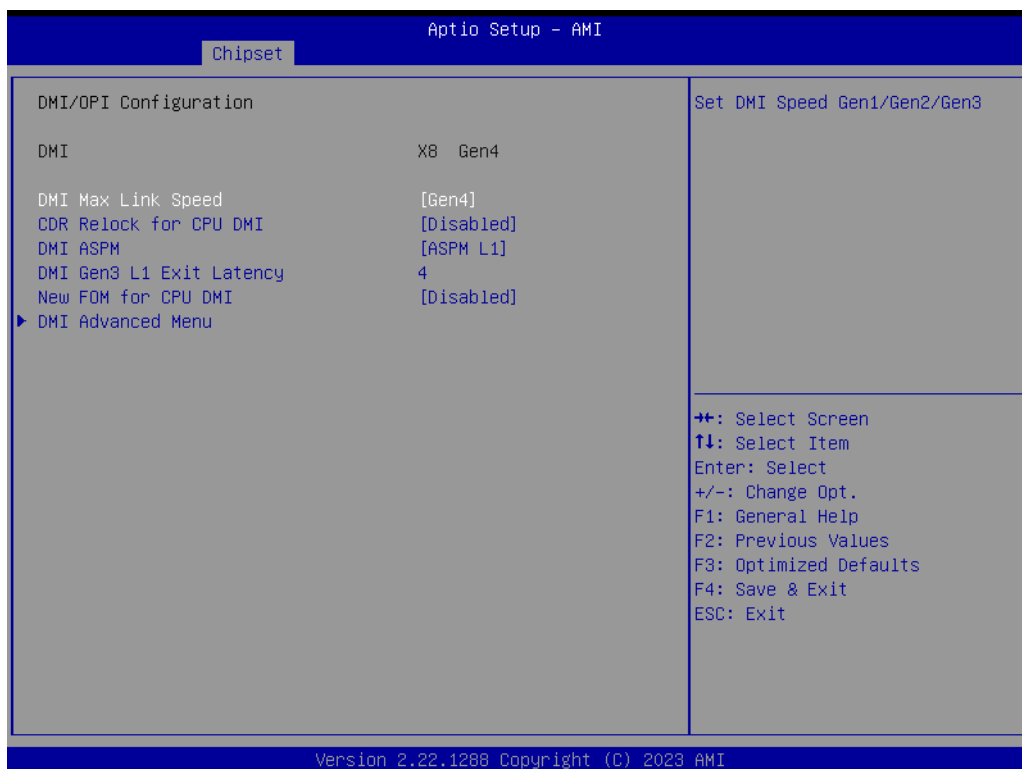

Figure 3.62

DMI Advanced Menu

Chipset → System Agent (SA) Configuration → DMI/OPI Configuration → DMI Advanced Menu

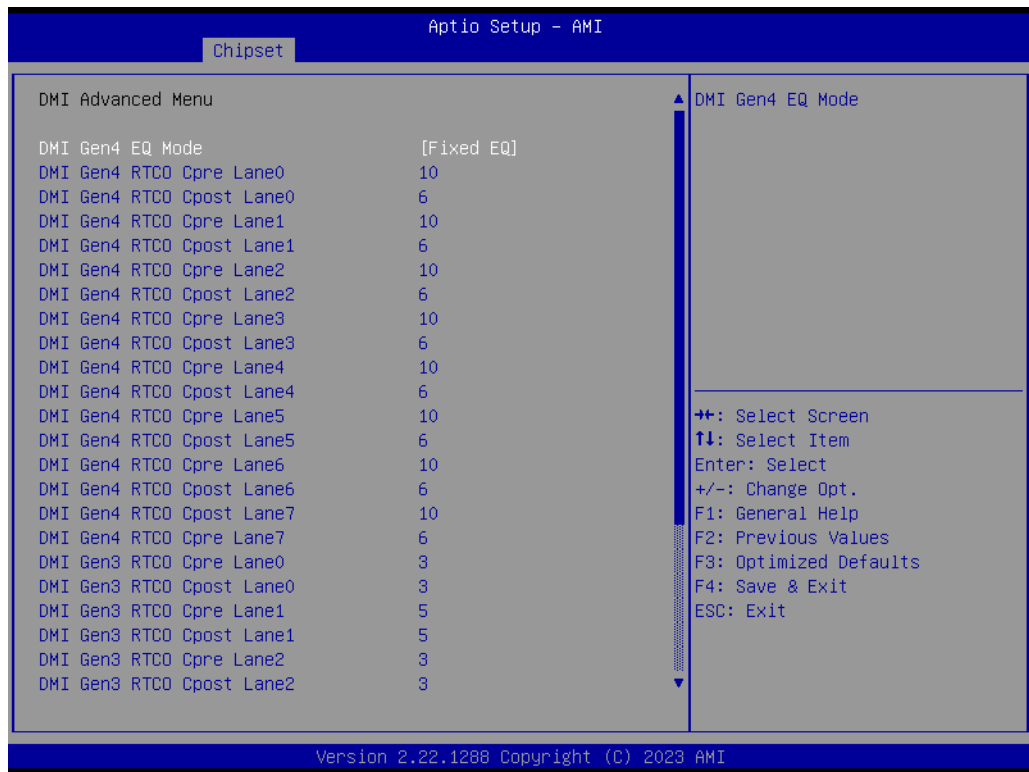

Figure 3.63

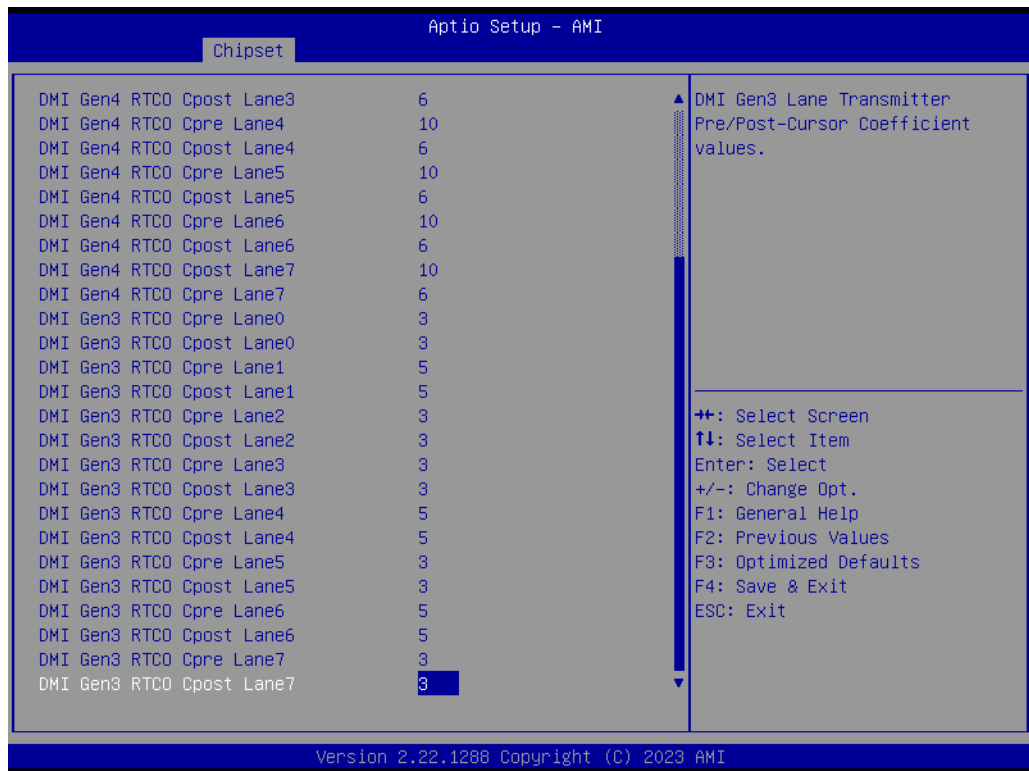

Figure 3.64

VMD Setup Menu

Chipset → System Agent (SA) Configuration → VMD Setup Menu



Figure 3.65

PCI Express Configuration

Chipset → System Agent (SA) Configuration → PCI Express Configuration



Figure 3.66

PCI Express Configuration

Chipset → System Agent (SA) Configuration → PCI Express Configuration → PCI EXPRESS SLOT

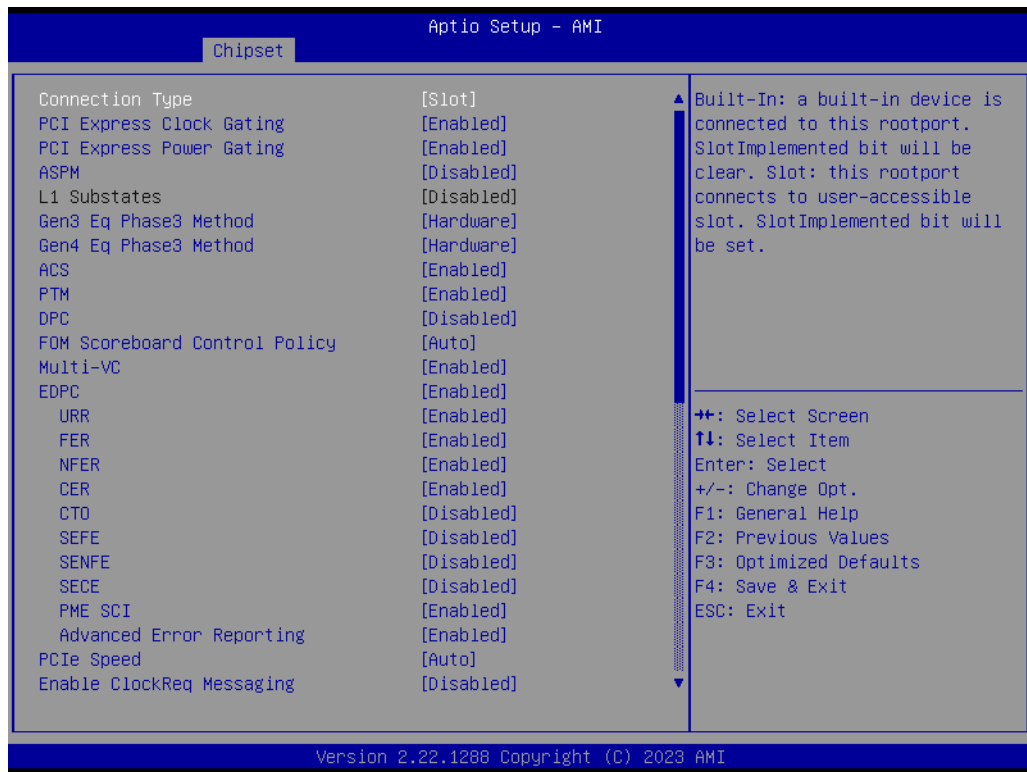

Figure 3.67

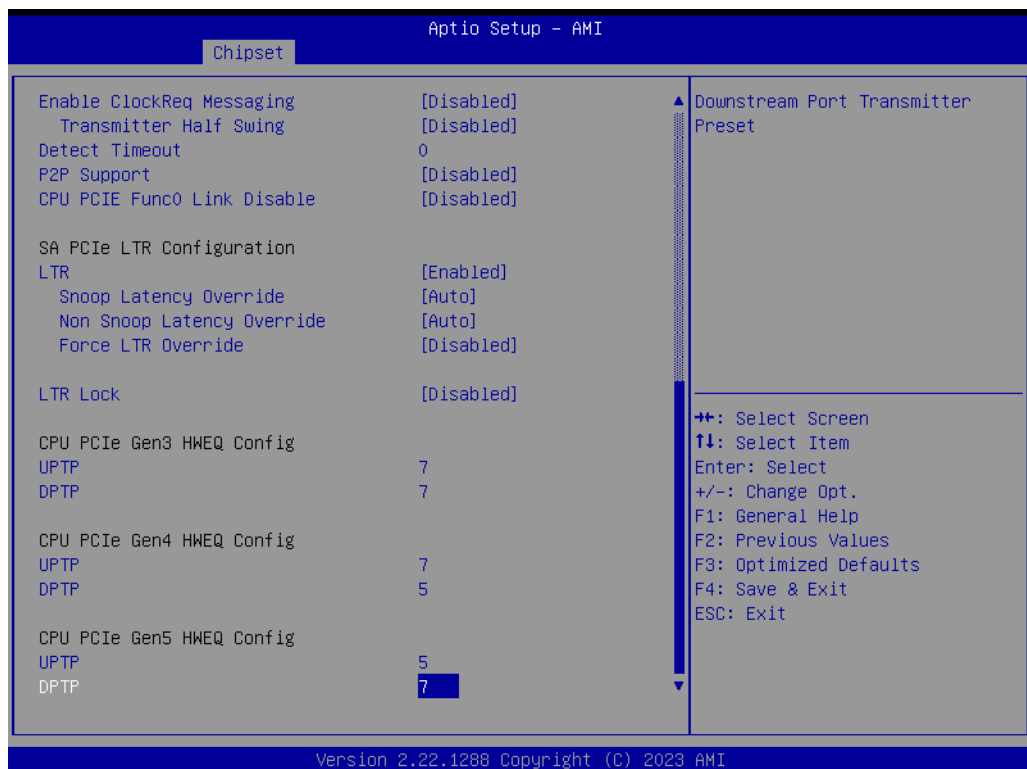

Figure 3.68

3.2.3.2 PCH-I/O Configuration

Chipset → PCH-I/O Configuration

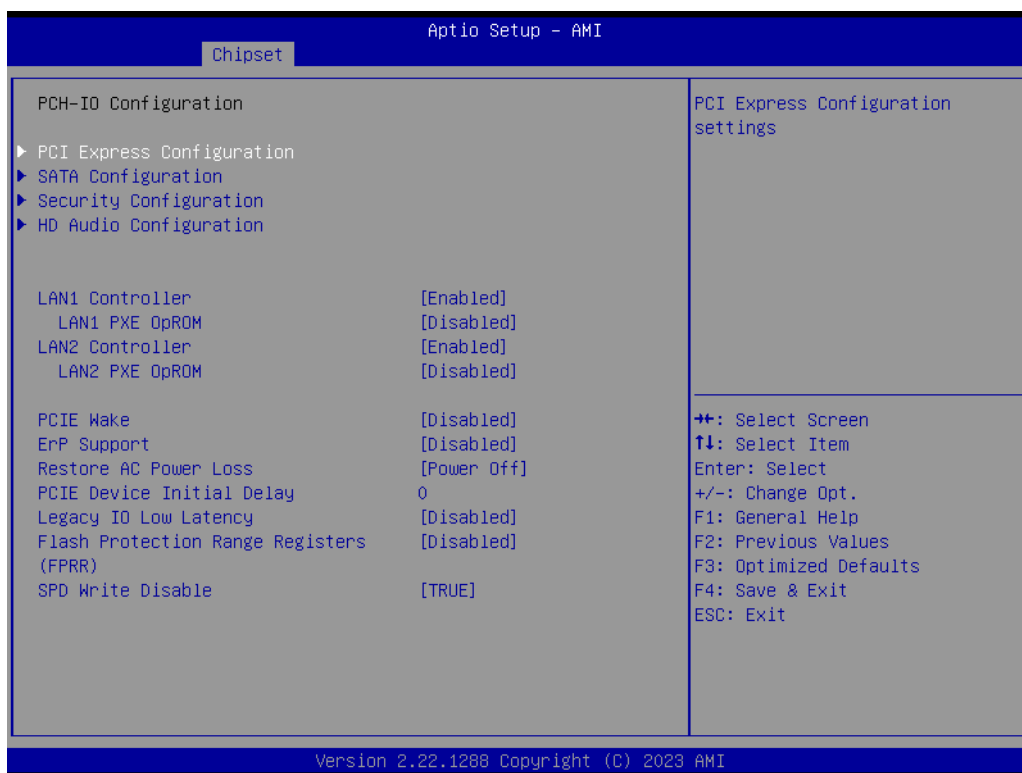

Figure 3.69

ErP Support Note

Chipset → PCH-I/O Configuration → ErP Support

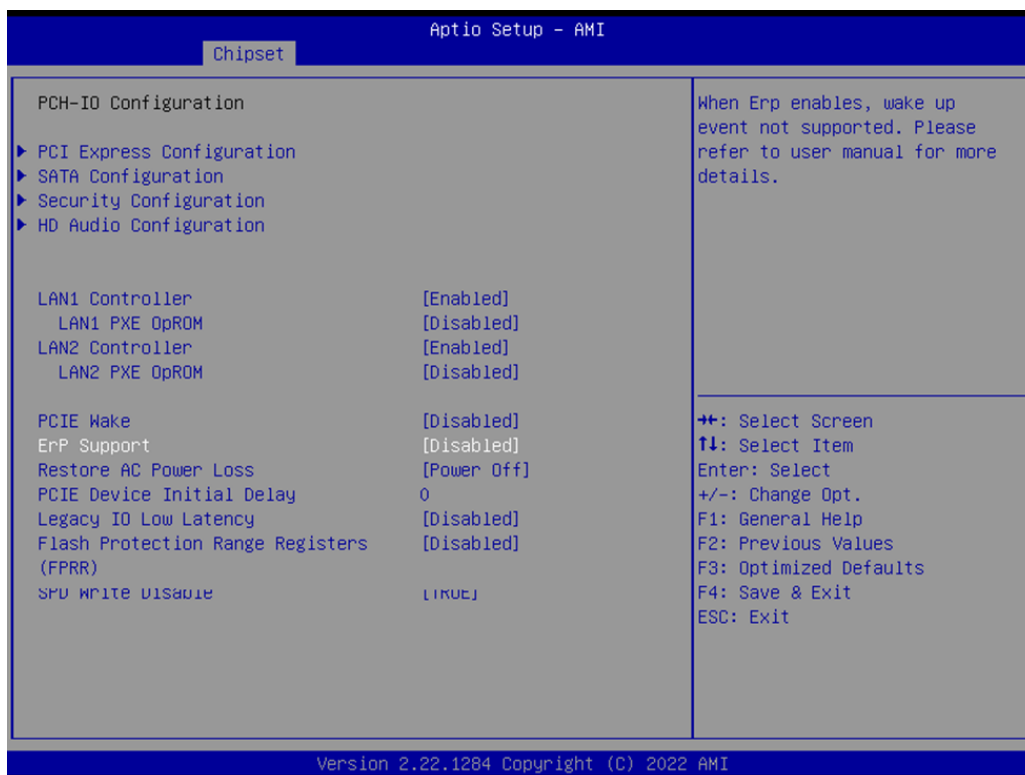

Figure 3.70

When ErP enables, restore AC power loss & below features are not supported.

[USB : S3/S4]

[PCIE Wake] Connect to PCIe slots, depending on add-on card driver behavior.

[RT: S5]

[WOR: S5]

[WOL: depends on LAN chip and driver behavior(GBE)]

Support S3/S4/S5 (with I219 & I226)

PCI Express Configuration

Chipset → PCH-I/O Configuration → PCI Express Configuration

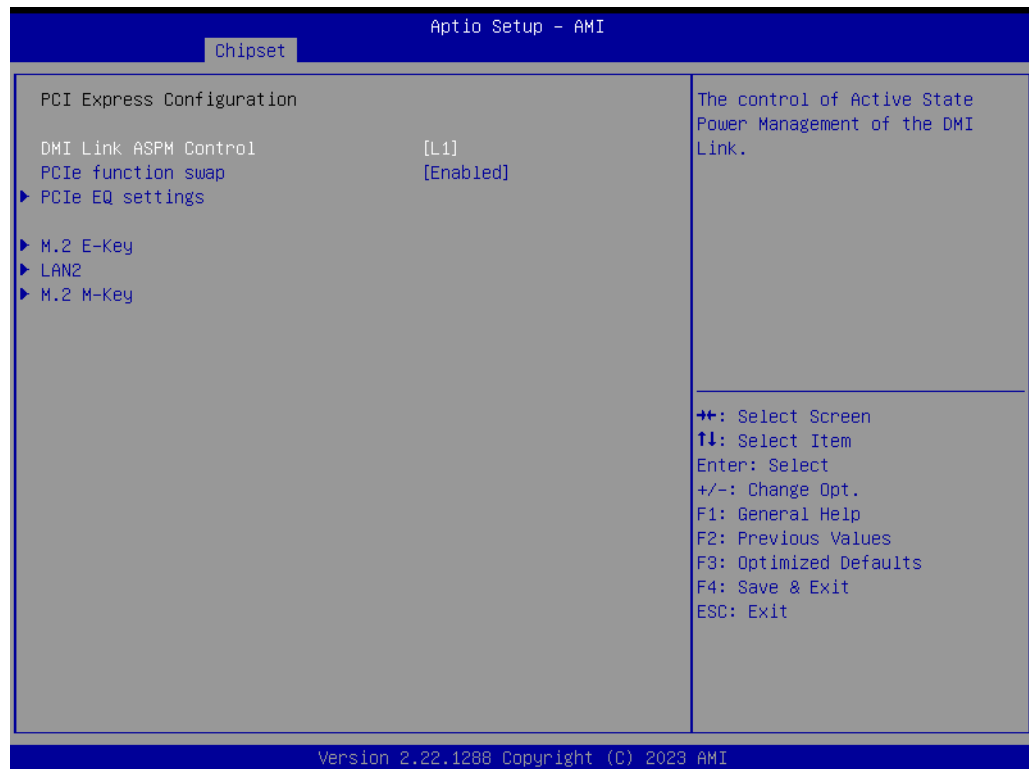

Figure 3.71

PCIe EQ Settings

Chipset → PCH-I/O Configuration → PCI Express Configuration → PCIe EQ Settings



Figure 3.72

LAN2

Chipset → PCH-I/O Configuration → PCI Express Configuration → LAN2

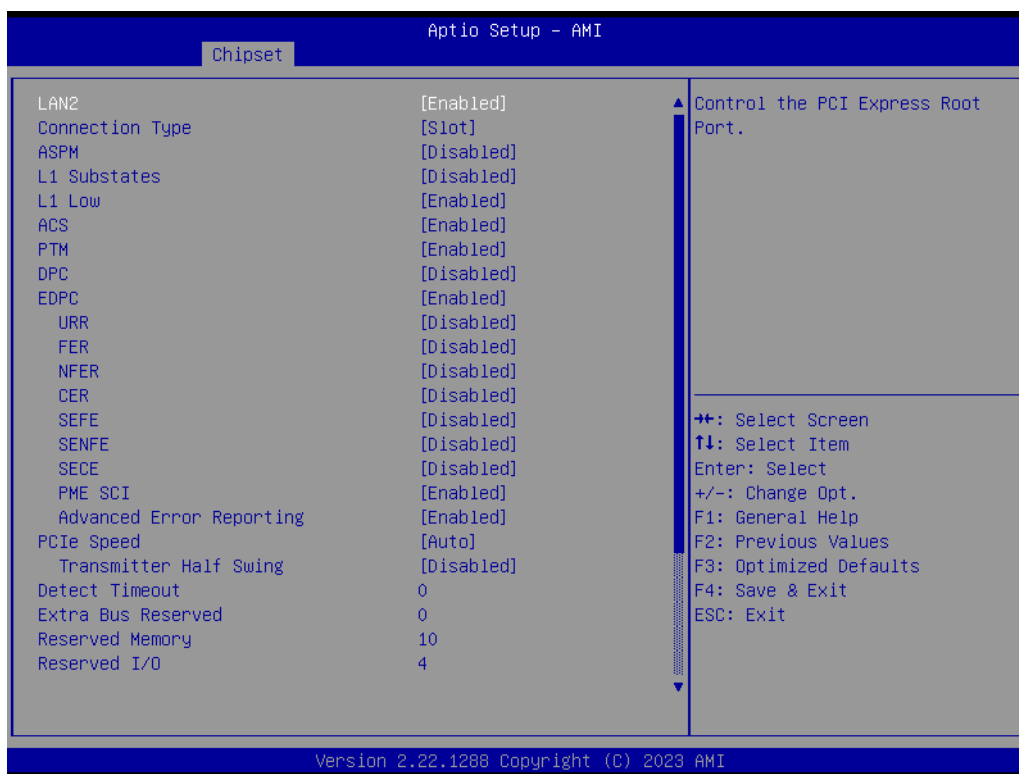

Figure 3.73

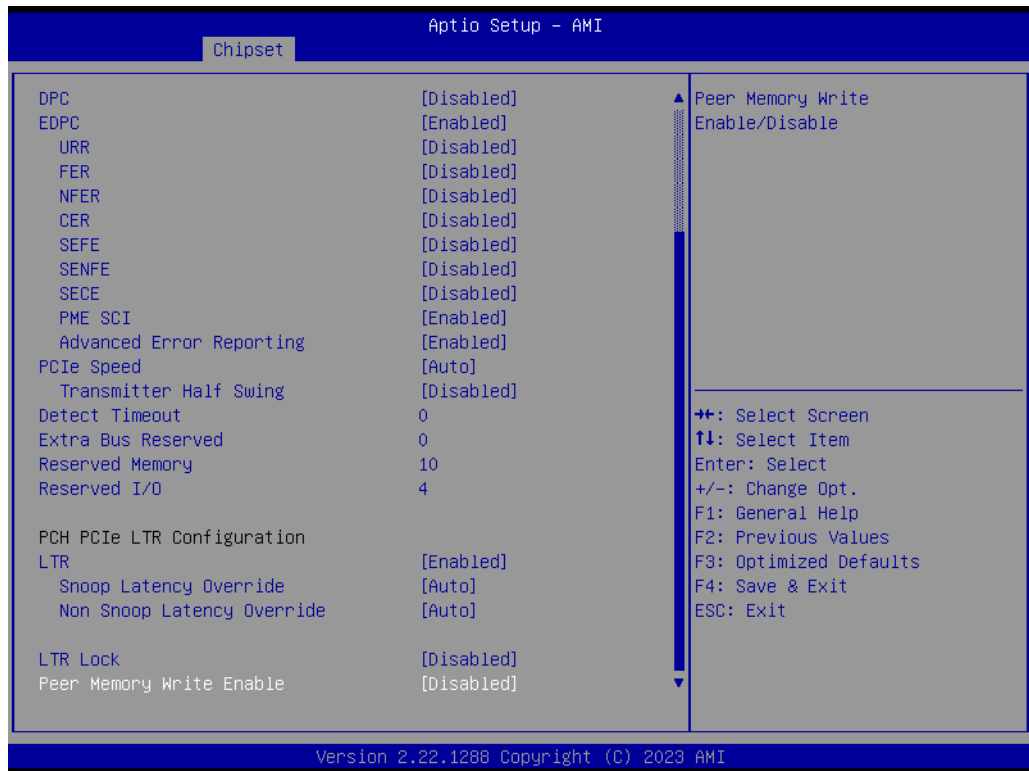

Figure 3.74

M.2 E-Key

Chipset → PCH-I/O Configuration → PCI Express Configuration → M.2 E-Key

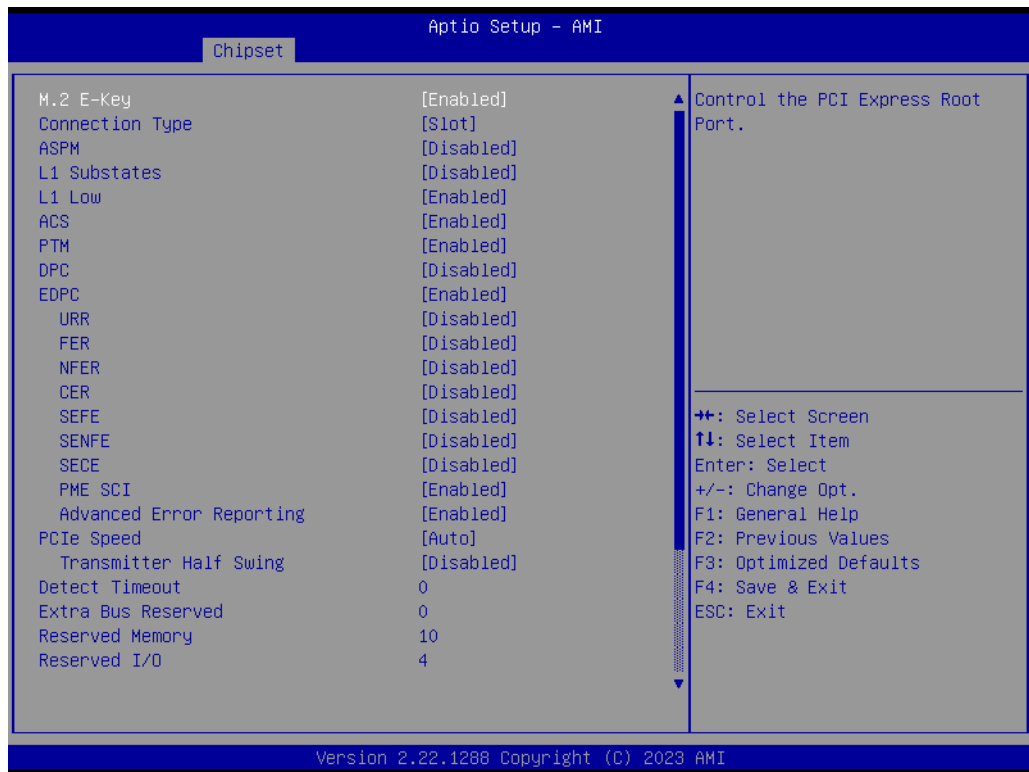

Figure 3.75

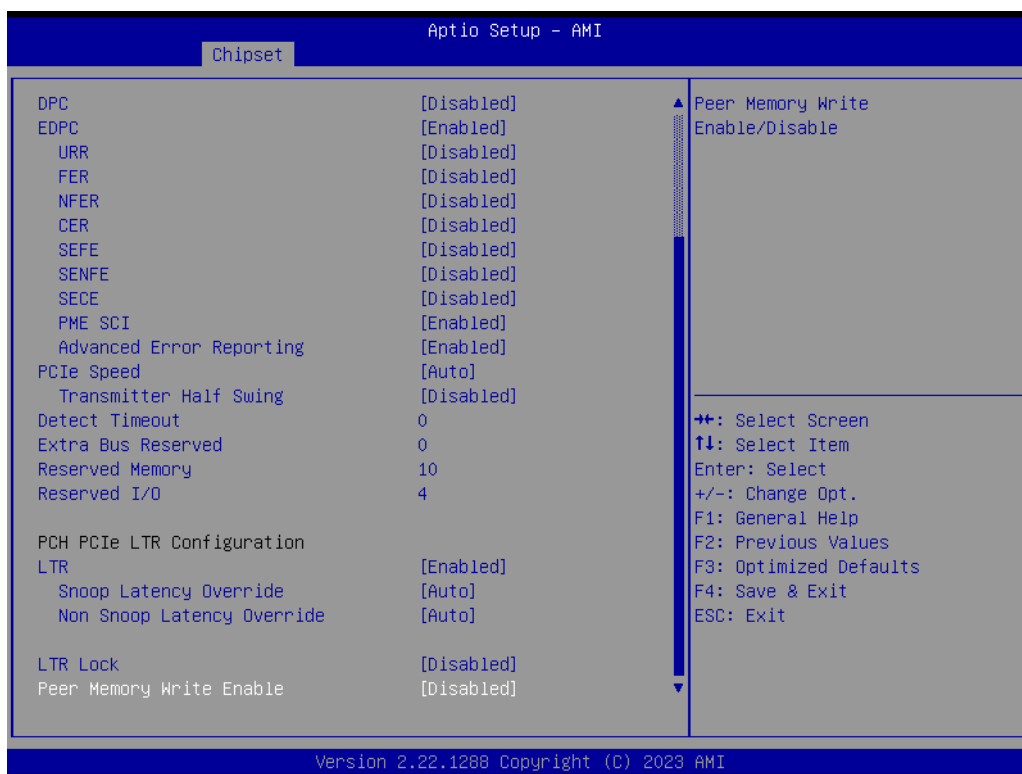

Figure 3.76

M.2 M-Key

Chipset → PCH-I/O Configuration → PCI Express Configuration → M.2 M-Key

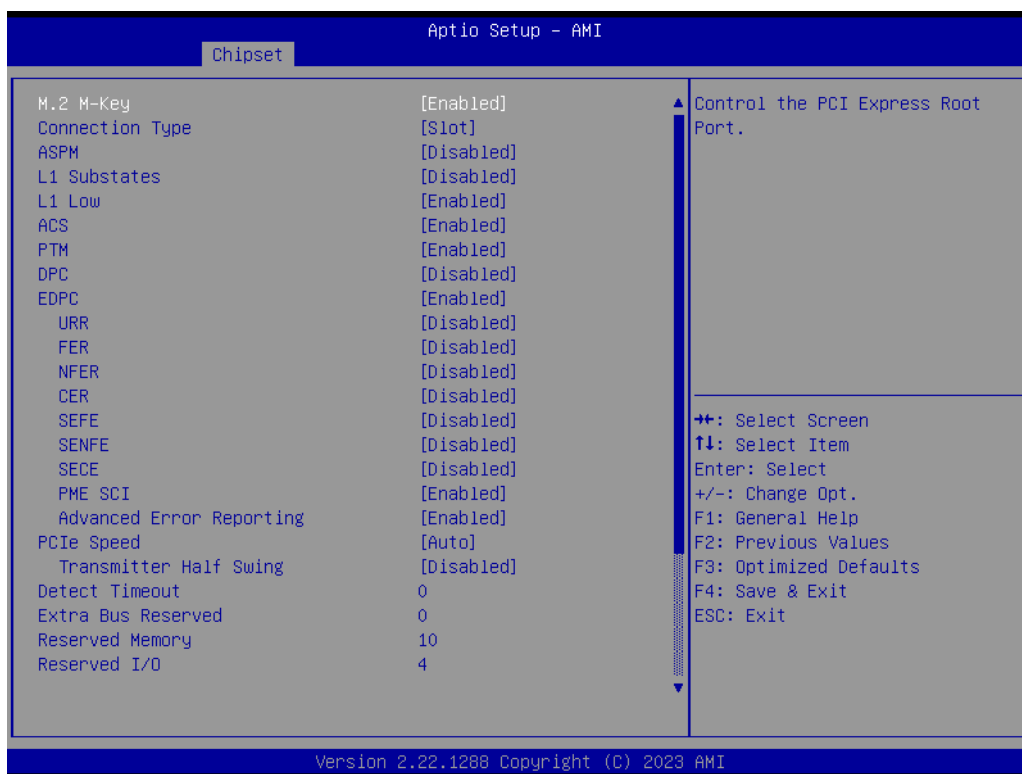

Figure 3.77

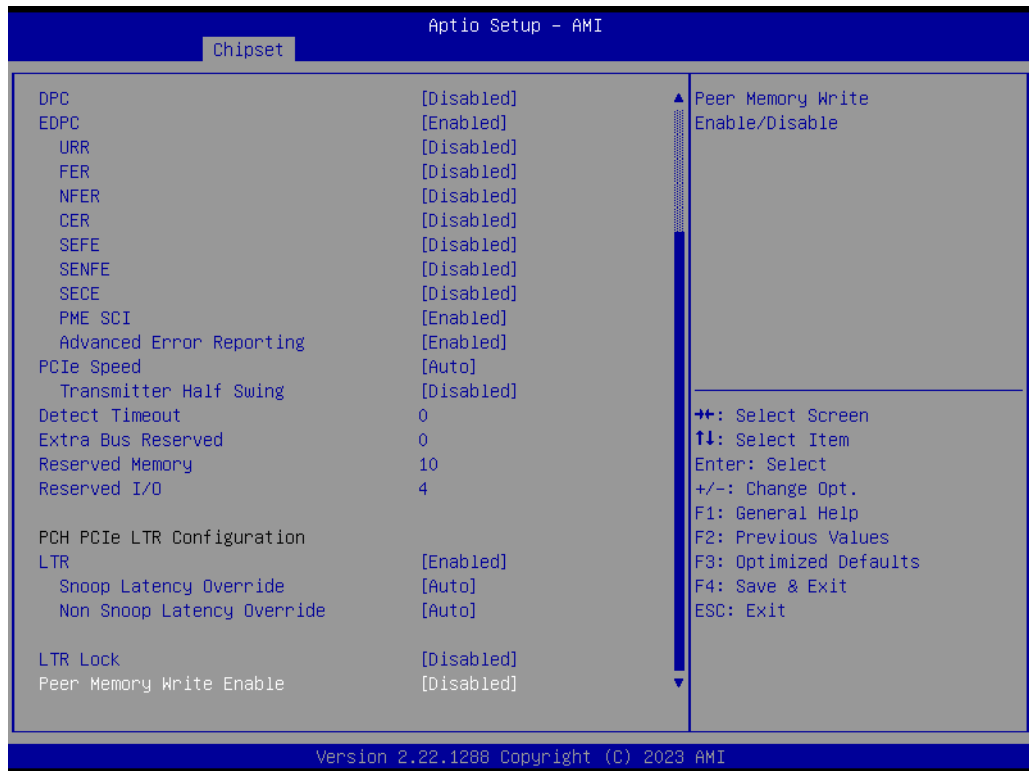

Figure 3.78

SATA Configuration

Chipset → PCH-I/O Configuration → SATA Configuration

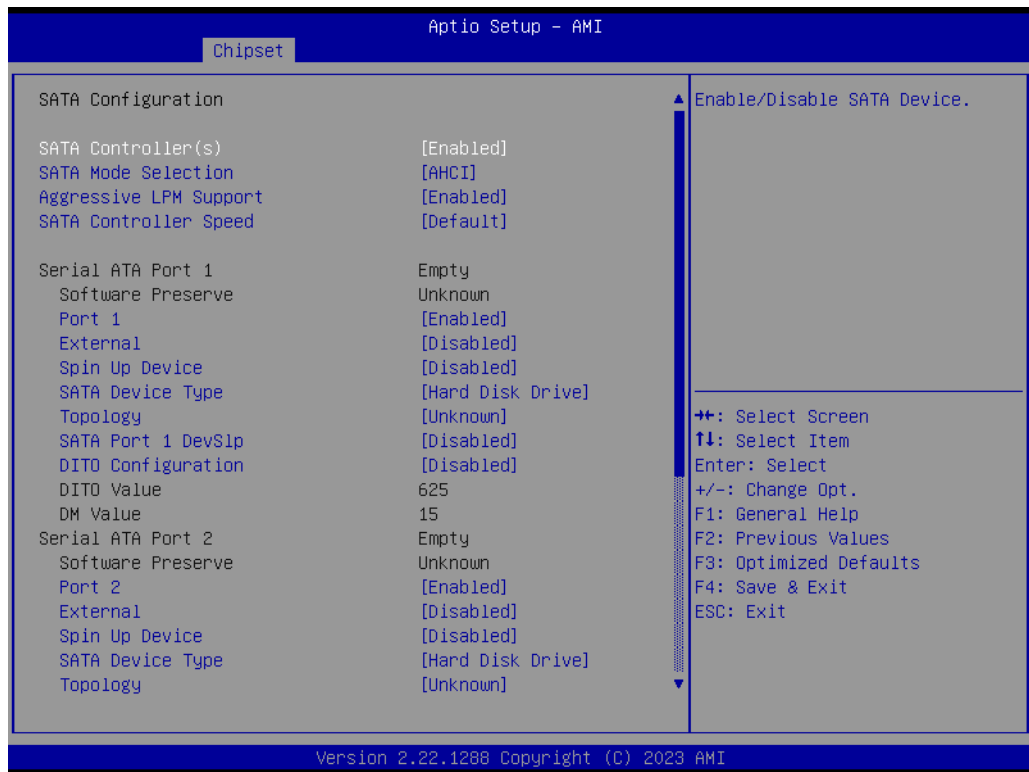

Figure 3.79

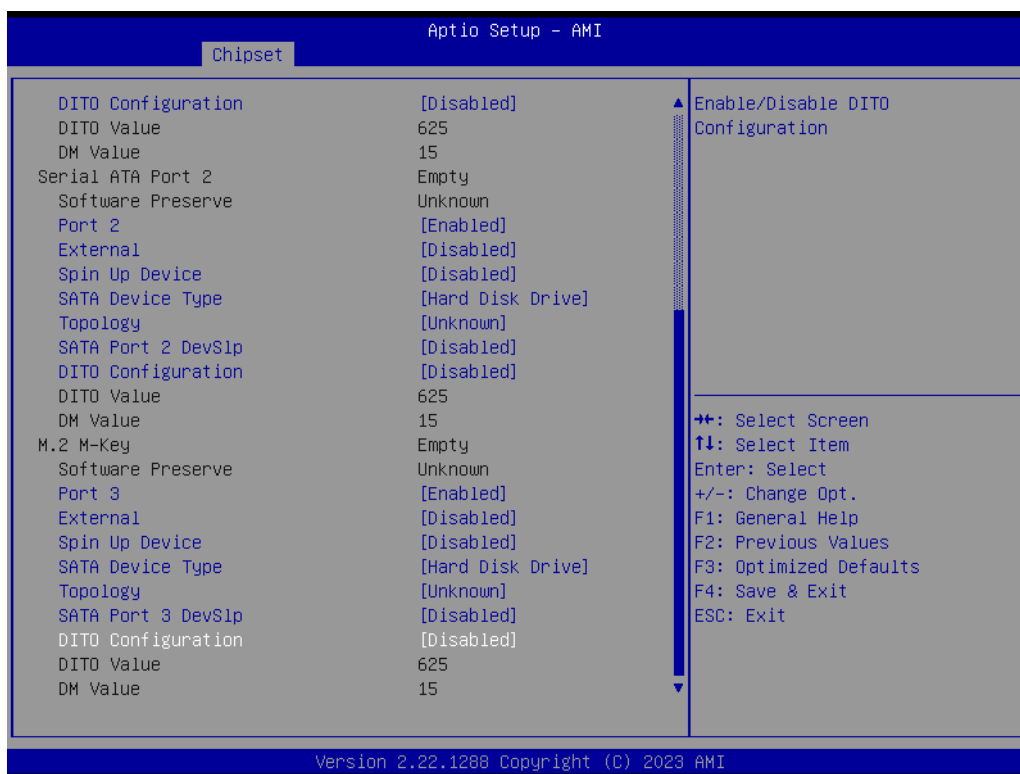

Figure 3.80

Security Configuration

Chipset → PCH-I/O Configuration → Security Configuration



Figure 3.81

HD Audio Subsystem Configuration Settings

Chipset → PCH-I/O Configuration → HD Audio Subsystem Configuration Settings

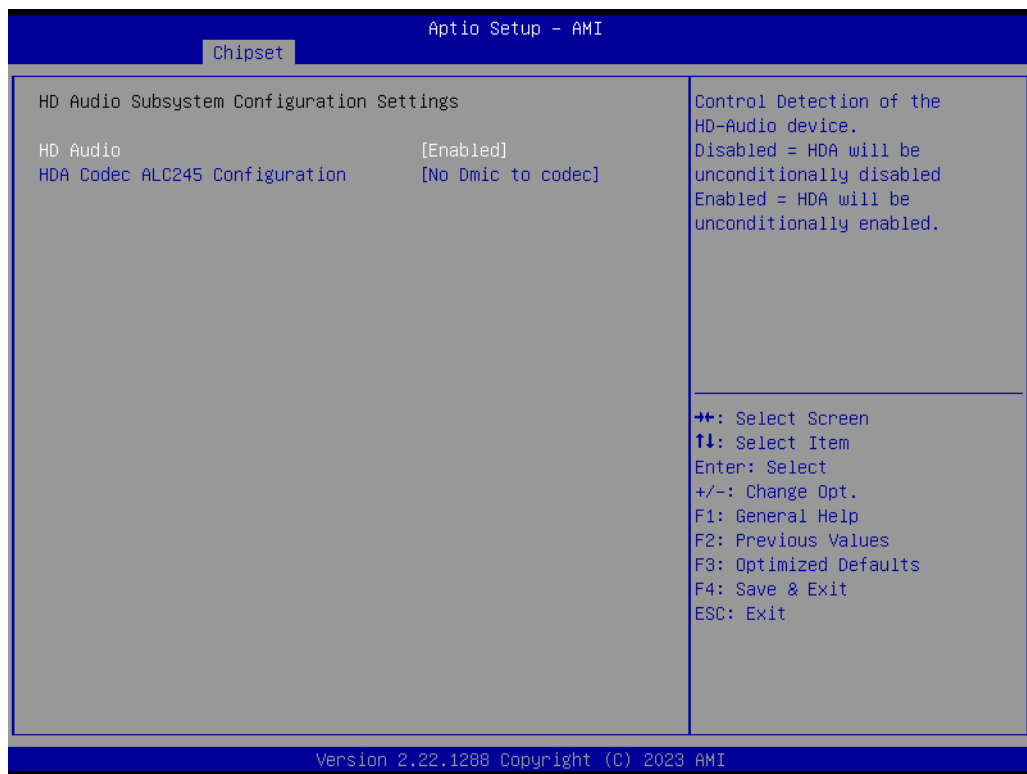

Figure 3.82

3.2.4 Security



Figure 3.83

- **Administrator Password**
Select this option and press <ENTER> to access the sub-menu, and then type in the password to set the Administrator password.
- **User Password**
Select this option and press <ENTER> to access the sub-menu, and then type in the password to set the User Password.

Secure Boot

Security → Secure Boot

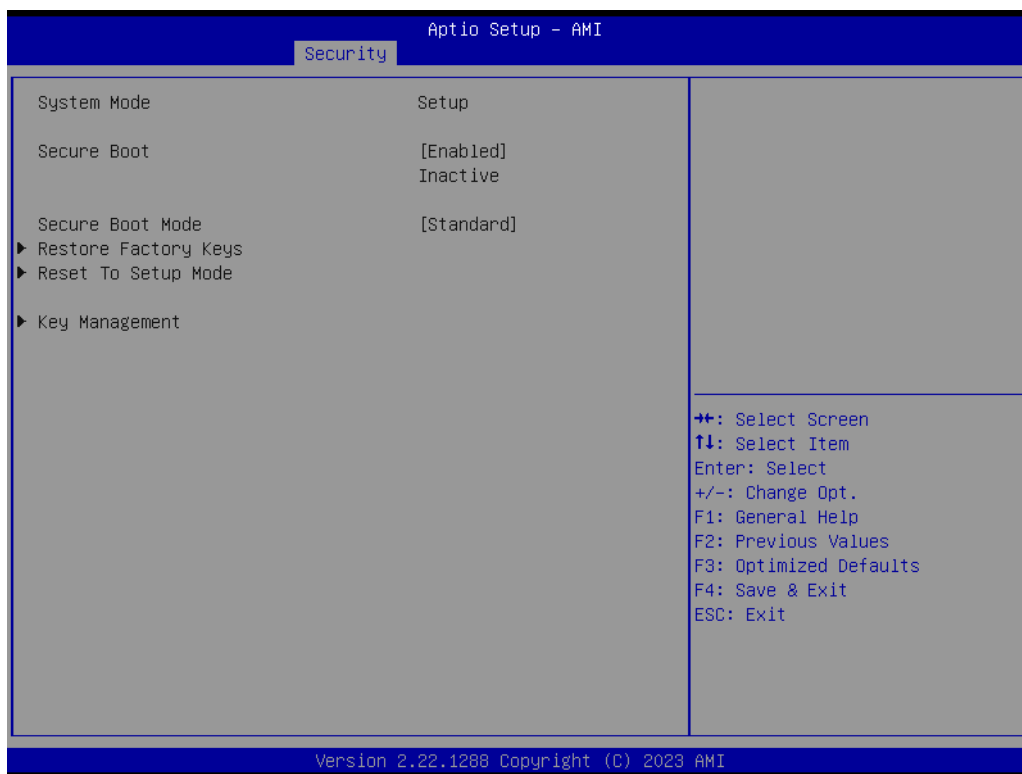

Figure 3.84

3.2.5 Boot Setting

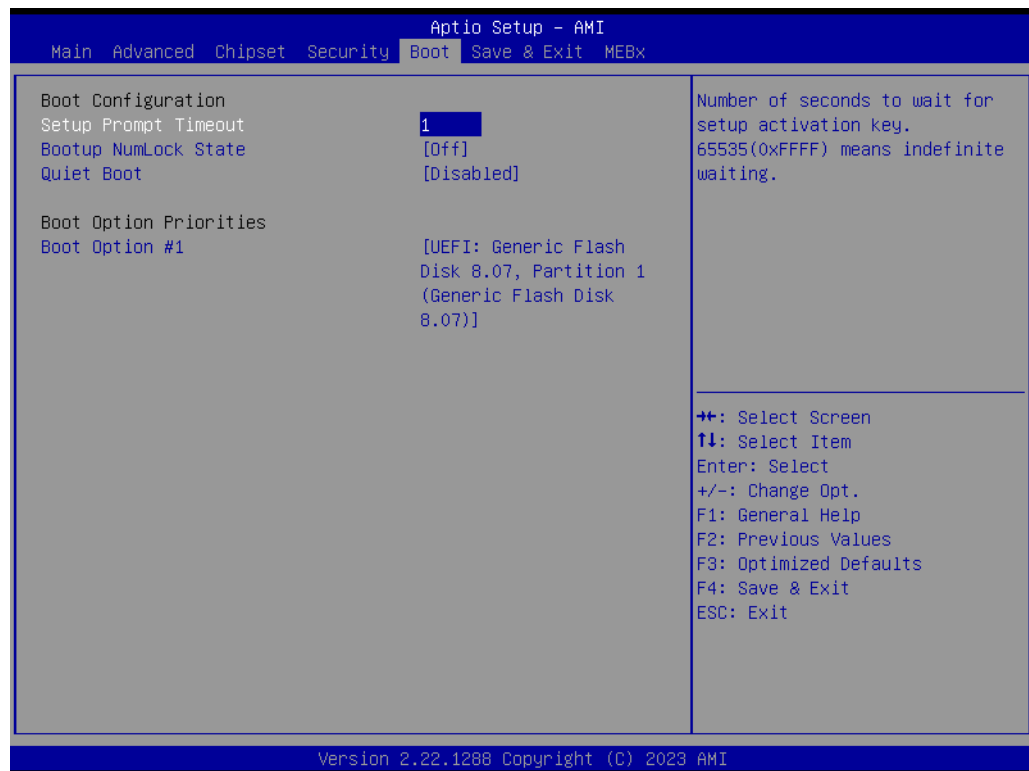

Figure 3.85

- **Setup Prompt Timeout**
Use the <+> and <-> keys to adjust the number of seconds to wait for the setup activation key.
- **Bootup NumLock State [Off]**
On or off power state for the NumLock.

3.2.6 Save & Exit Configuration

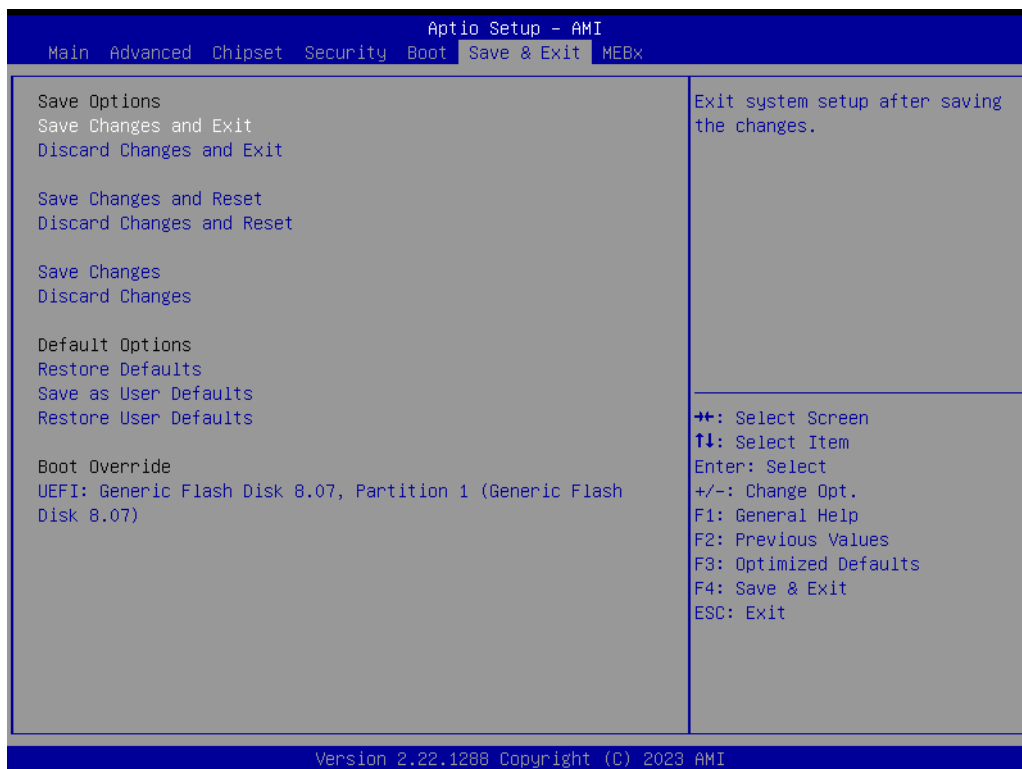

Figure 3.86

- **Save Changes and Exit**
 When users have completed system configuration, select this option to save changes, exit the BIOS setup menu, and reboot the computer to take effect of all system configuration parameters.

 1. Select **Save Changes and Exit** from the Save & Exit menu and press <Enter>. The following message appears: Save Configuration Changes and Exit Now?
 2. Select [Ok] or [Cancel]
- **Discard Changes and Exit**
 Select this option to quit setup without making any permanent changes to the system configuration.

 1. Select **Discard Changes and Exit** from the Save & Exit menu and press <Enter>. The following message appears: Discard Changes and Exit setup now? [Ok] or [Cancel]
 2. Select Ok to discard changes and exit.
- **Save Changes and Reset**
 When users have completed system configuration, select this option to save changes, exit the BIOS setup menu and reboot the computer for it to take effect.

 1. Select **Save Changes and Reset** from the Save & Exit menu and press <Enter>. The following message appears: Save Configuration Changes and Exit Now? [Ok] or [Cancel]
 2. Select [Ok] or [Cancel]
- **Discard Changes and Reset**
 Select this option to quit Setup without making any permanent changes to the system configuration.

 1. Select **Discard Changes and Reset** from the Save & Exit menu and press <Enter>. The following message appears: Discard Changes and Exit Setup

Now? [Ok] or [Cancel]

2. Select Ok to discard changes and reset.

- **Restore Default**

The BIOS automatically configures all setup items to optimal settings when users select this option. Defaults are designed for maximum system performance, but may not work best for all computer applications. In particular, do not use the Defaults if the user's computer is experiencing system configuration problems. Select Restore Defaults from the Exit menu and press <Enter>.

- **Save as User Default**

Save the all current settings as a user default.

- **Restore User Default**

Restore all settings to user default values.

- **Boot Override**

Shows the boot device types on the system.

Chapter 4

Software Introduction
& Services

4.1 Introduction

The mission of Advantech Embedded Software Services is to "Enhance quality of life with Advantech platforms and Microsoft® Windows® embedded technology." We enable Windows® Embedded software products on Advantech platforms to more effectively support the embedded computing community. Customers are freed from the hassle of dealing with multiple vendors (hardware suppliers, system integrators, embedded OS distributors) for projects. Our goal is to make Windows® Embedded Software solutions easily and widely available to the embedded computing community.

4.2 Value-Added Software Services

Software API: It is an interface that defines the ways by which an application program may request services from libraries and/or operating systems. It provides not only the underlying drivers required but also a rich set of user-friendly, intelligent, and integrated interfaces, which speeds development, enhances security, and offers add-on value for Advantech platforms. It plays the role of catalyst between developer and solution, and makes Advantech embedded platforms easier and simpler to adopt and operate with customer applications.

4.2.1 Software API

4.2.1.1 Control

GP I/O



General Purpose Input/Output is a flexible parallel interface that allows a variety of custom connections. It allows users to monitor the level of signal input or set the output status to switch on/off the device. Our API also provides Programmable GPIO, which allows developers to dynamically set the GPIO input or output status.

SMBus



SMBus is the System Management Bus defined by Intel Corporation in 1995. It is used in personal computers and servers for low-speed system management communications. The SMBus API allows a developer to interface with an embedded system environment and transfer serial messages using the SMBus protocols, allowing multiple simultaneous device control.

4.2.1.2 Display

Brightness Control



The Brightness Control API allows developers to access embedded devices and easily control brightness.

4.2.1.3 Monitor

Watchdog



A watchdog timer (WDT) is a device that performs a specific operation after a certain period of time if something goes wrong and the system does not recover on its own. A watchdog timer can be programmed to perform a warm boot (restarting the system) after a certain number of seconds.

Hardware Monitor



The Hardware Monitor (HWM) API is a system health supervision API that inspects certain condition indexes, such as fan speed, temperature, and voltage.

Chapter 5

Chipset Software
Installation Utility

5.1 Before you Begin

To facilitate the installation of the enhanced display drivers and utility software, read the instructions in this chapter carefully. The drivers for the AIMB-279 are located on the Advantech support website: <http://support.advantech.com/support>. The drivers on the support website will guide and link you to the utilities and drivers under a Windows system. Updates are provided via Service Packs from Microsoft*.

 **Note!** *The driver files on the website are compressed. Do not attempt to install the drivers by copying the files manually. You must download the files and decompress them first. Also, please use the supplied SETUP program to install the drivers.*

Before you begin, it is important to note that most display drivers need to have the relevant software application already installed in the system prior to installing the enhanced display drivers. In addition, many of the installation procedures assume that you are familiar with both the relevant software applications and operating system commands. Review the relevant operating system commands and the pertinent sections of your application software's user manual before performing the installation.

5.2 Introduction

The Intel Chipset Software Installation (CSI) utility installs the Windows INF files that outline to the operating system how the chipset components will be configured. This is needed for the proper functioning of the following features:

- Core PCI PnP services
- Serial ATA interface support
- USB support
- Identification of Intel chipset components in the Device Manager

 **Note!** *This utility is used for the following versions of Windows, and it has to be installed **before** installing all the other drivers:*

- Windows 10 (64-bit)

Chapter 6

Display Driver Setup

6.1 Introduction

The 12/13th Gen Intel® Core™ i processors are embedded with an integrated graphics controller. You need to install the driver to enable the function.

Optimized integrated graphics solution: Intel Flexible Graphics supports versatile display options and a 3D graphics engine. The dual independent displays include enhanced display modes for widescreen flat panels for extended, twin, clone, and dual display modes. The optimized 3D support delivers an intensive and realistic visual experience.

6.2 Windows 10 Display Driver Installation

Note! *Before installing this driver, make sure the CSI utility has been installed in your system. See Chapter 5 for information on installing the CSI utility.*



Download the driver from the website to your computer. Navigate to the “AIMB-279 Technical Downloads” folder and complete the installation of the drivers for Windows 10.

Chapter 7

LAN Configuration

7.1 Introduction

The AIMB-279 has two Gigabit Ethernet LANs via dedicated PCI Express x1 lanes, Intel® i226 and I219LM (Phy) that offer bandwidth of up to 500 MB/sec, eliminating the bottleneck of network data flow and incorporating Gigabit Ethernet at 2500 Mbps.

7.2 Features

- Integrated 10/100/1000/2500 Mbps transceiver
- 10/100/1000/2500 Mbps triple-speed MAC
- High-speed RISC core with 24KB cache
- On-chip voltage regulation
- Wake-on-LAN (WOL) support
- PCI Express x1 host interface

7.3 Installation

Note! *Before installing this driver, make sure the CSI utility has been installed in your system. See Chapter 5 for information on installing the CSI utility.*



AIMB-279's Intel® i226 and Intel® i219LM Gigabit integrated controllers support all major network operating systems. However, the installation procedure varies from system to system. Please find and use the section that provides the driver setup procedure for the OS you are using.

7.4 Windows® 10 Driver Setup (Intel® i219LM & Intel® i226)

Download the driver from the support website to your computer and decompress the file. Select "Autorun", then navigate to the directory for your OS.

Note! *Before installing this driver, make sure the CSI utility has been installed in your system. See Chapter 5 for information on installing the CSI utility.*



ADVANTECH

Enabling an Intelligent Planet

www.advantech.com

Please verify specifications before quoting. This guide is intended for reference purposes only.

All product specifications are subject to change without notice.

No part of this publication may be reproduced in any form or by any means, such as electronically, by photocopying, recording, or otherwise, without prior written permission from the publisher.

All brand and product names are trademarks or registered trademarks of their respective companies.

© Advantech Co., Ltd. 2024