

CS-110H/P1001 Series

10.4" TFT-LCD Sunlight Readable Touch Panel PC with Intel® Atom™ E3845 Quad Core Processor



- 10.4" TFT-LCD with Ultra High Brightness up to 1,500 nits and 1024 x 768 (XGA) Resolution
- Onboard Intel® Atom™ E3845 Processor Quad Core, 1.91GHz
- Supports 1x DDR3L SO-DIMM Socket, up to 8 GB
- 1x 2.5" SATA Drive Bay, 1x CFast Card and 1x SIM Card Socket
- 2x GbE LAN, 4x USB, 2x COM, 1x VGA, 1x DisplayPort, 4x DI/4x DO
- 1x Mini-PCle Expansion Socket for Wireless and I/O Expansion
- Wide Range Operating Temperature -20°C to 70°C
- Designed with Aluminum Die-casting Front Frame
- True Flat IP65 Front Panel Protection
- Supports Panel / VESA / Rack Mounting
- Convertible Display System (CDS) Technology Supported
- 2x Universal I/O Bracket (For P1001E only)

Overview

CS-110/P1001 Series is a 10.4" TFT-LCD sunlight readable touch panel PC offering 1,500 nits ultra high brightness and 1024 x 768 (XGA) resolution. The system is equipped with Intel® Atom® E3845 processor and provides extensive I/O including 2x GbE, 4x USB, 2x RS232/422/485, 4x DI/4x DO, 1x VGA and 1x DisplayPort. It also supports 1x Mini-PCle slot, 1x SIM socket, and 2x Universal I/O Bracket(For P1001E only) for a variety of wireless connections, such as BT/WiFi and 3G/LTE. In addition, there are 2 types of storage devices including 2.5" SATA HDD and CFast. The accessible design of these storage devices allows quick data access and easy maintenance.

CS-110/P1001 Series supports Convertible Display System (CDS) technology. Comparing to regular standalone panel PCs, it can lower maintenance cost and reduce unplanned downtime. Furthermore, CS-110/P1001 Series is a truly rugged display system supporting wide range operating temperature (-20°C to 70°C), IP65 dust/water proof front panel, wide range DC power input (9 to 48VDC) and rigorous industrial protections.

Highlights



Sunlight Readable

Providing ultra high brightness 1,500 nits and resolution up to 1024 x 768 (XGA), CS-110/P1000 Series is suitable for all lighting conditions including direct sunlight.



Wide Temperature

CS-110/P1000 Series supports wide range operating temperature from -20°C to 70°C and is suitable for deploying in extreme and harsh environments.



Multiple Functions

CS-110/P1000 Series provides extensive I/O, Mini-PCle slot, 2.5" SATA drive bay, CFast socket, and SIM card slot.

CS-110H Specifications

Model Name	CS-110HC
Display	
LCD Size	• 10.4" (4:3)
Max. Resolution	• 1024 x 768
Brightness (cd/m2)	• 1500
Contrast Ratio	• 1400 : 1
LCD Color	• 16.2M
Pixel Pitch (mm)	• 0.206 (H) x 0.206 (V)
Viewing Angle (H-V)	• 178 / 178
Backlight MTBF	• 50000 hrs (LED Backlight)
Touch Screen	
Touch Type	• Projected Capacitive
Physical	
Dimension (W x D x H)	• 295 x 227.3 x 56.2 mm
Weight Information	• 2.24 kg
Mechanical Construction	• Flat Rugged Aluminum Die-casting Bezel
Environment	
Front Panel Protection	• IP 65 Compliant
Operating Temperature	• Ambient with Air flow: -20°C to 70°C(extended temperature peripherals)
Storage Temperature	• -20°C to 70°C
Relative Humidity	• 80% RH @ 40°C (Non-Condensing)
EMC	• CE, UKCA, FCC, ICES-003 Class A

P1001 Specifications

Model Name	P1001	P1001E
System		
Processor	• Onboard Intel® Atom™ Processor E3845 Quad Core, 1.91 GHz	
Memory	• 1x DDR3L 1066/1333 MHz SO-DIMM Socket (un-buffered and non-ECC) • Support up to 8 GB	
BIOS	• AMI 64Mbit SPI BIOS	
Graphics		
VGA	• 1x VGA Connector (1920x1080@60Hz)	
DP	• 1x DisplayPort Connector (1920x1080@60Hz)	
Audio		
Line-out	• 1x Line-out, Phone Jack 3.5mm	
Mic-in	• 1x Mic-in, Phone Jack 3.5mm	
I/O		
LAN	• 2x GbE LAN (Supports WoL, Teaming, Jumbo Frame & PXE), RJ45 - GbE1: Intel® I219-LM - GbE2: Intel® I210	
USB	• 1x USB 3.2 Gen1 (Type A), 3x USB 2.0 (Type A)	
COM	• 2x DB9 for COM1~2, Support RS232/422/485 with Auto Flow Control	
DIO	• 8x Digital I/O (4in/4out)	
Power Mode Switch	• 1x AT/ATX Mode Switch	
Power Switch	• 1x Power Switch	
Reset Button	• 1x Reset Button	
Storage		
SSD/HDD	• 1x 2.5"SATA HDD Bay	
CFast	• 1x External CFast Socket	
SIM Card	• 1x External SIM Card Socket	
Expansion		
Mini PCI Express	• 1x Full-size Mini PCIe Socket for Wi-Fi/GSM/Expansion Module	
I/O Brackets		• 2x Universal I/O Brackets
Other Function		
Watchdog Timer	• Software Programmable Supports 256 Levels System Reset	
Internal Speaker	• AMP 2W + 2W (Internal Speaker)	
OSD Function	• LCD On/Off, Brightness Up, Brightness Down	
Power		
AT/ATX Power	• Support AT, ATX Mode	
Power Input	• 1x 3-pin Terminal Block Connector with Power Input 9~48VDC	
Power Adapter (Optional)	• 1x Optional AC/DC 12V/5A, 60W Power Adapter	

Physical		
Dimension (W x D x H)	• 204.5 x 149 x 37.5 mm	• 204.5 x 150 x 60 mm
Weight Information	• 1.34kg	• 1.54kg
Mechanical Construction	• Extruded Aluminum with Heavy Duty Metal	
Mounting	• Wall / VESA / CDS Mounting	
Reliability & Protection		
Reverse Power Input	• Yes	
Over Voltage Protection	<ul style="list-style-type: none"> • Protection Range: 51~58V • Protection Type: shut down operating voltage, re-power on at the present level to recover 	
Over Current Protection	• 20A	
ESD Protection	• +/-8kV (air), +/-4kV (contact)	
Surge Protection	• 2kV	
Operating System		
Microsoft® Windows®	<ul style="list-style-type: none"> • Windows® 10, Windows® 8, Windows® 7 • Windows® Embedded 8 Standard, Windows® Embedded Standard 7 	
Linux	• Supports by project	
Environment		
Operating Temperature	• Ambient with Air Flow: -20°C to 70°C (with Industrial Grade Peripherals)	
Storage Temperature	• -30°C to 85°C	
Relative humidity	• 10%~95% (non-condensing)	
Shock	• Operating, 15 Grms, Half-sine 11 ms Duration (w/ SSD, according to IEC60068-2-27)	
Vibration	• Operating, 1 Grms, 5-500 Hz, 3 Axes (w/ SSD, according to IEC60068-2-64)	
EMC	• CE, UKCA, FCC, ICES-003 Class A	

CS-110H/P1001 External Layout

Front I/O

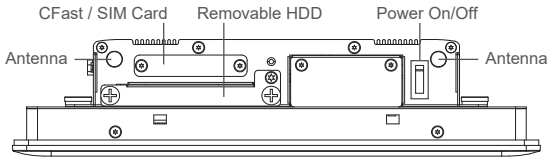

Rear I/O

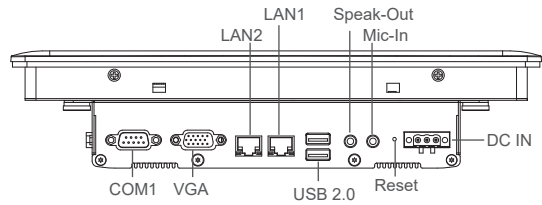

Left I/O

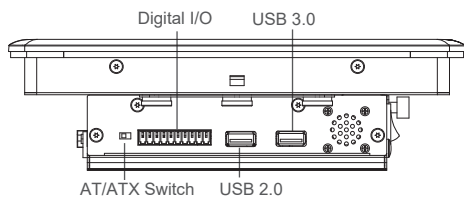

Right I/O

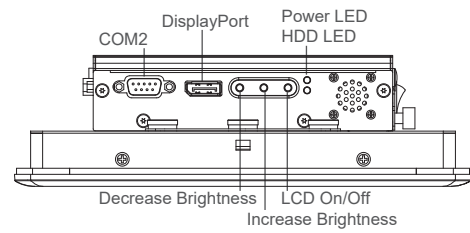

CS-110H/P1001E External Layout

Front I/O

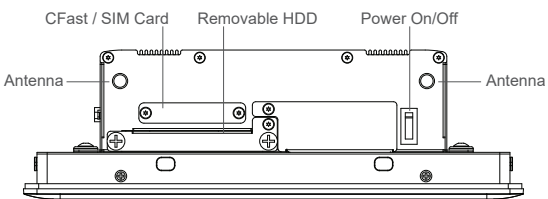

Rear I/O

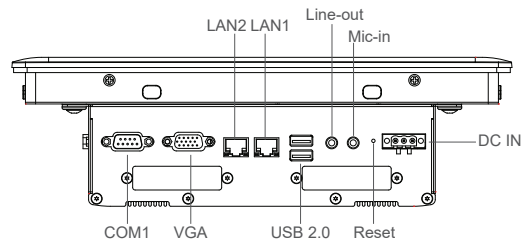

Left I/O

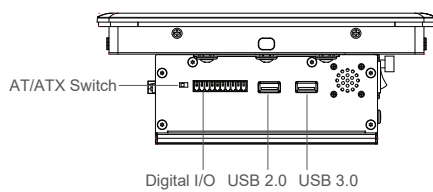

Right I/O

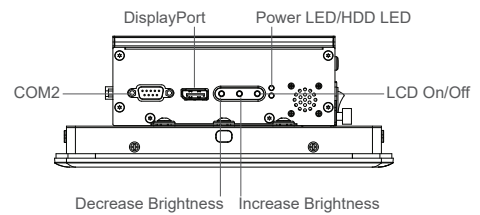

CS-110H/P1001 Dimensions

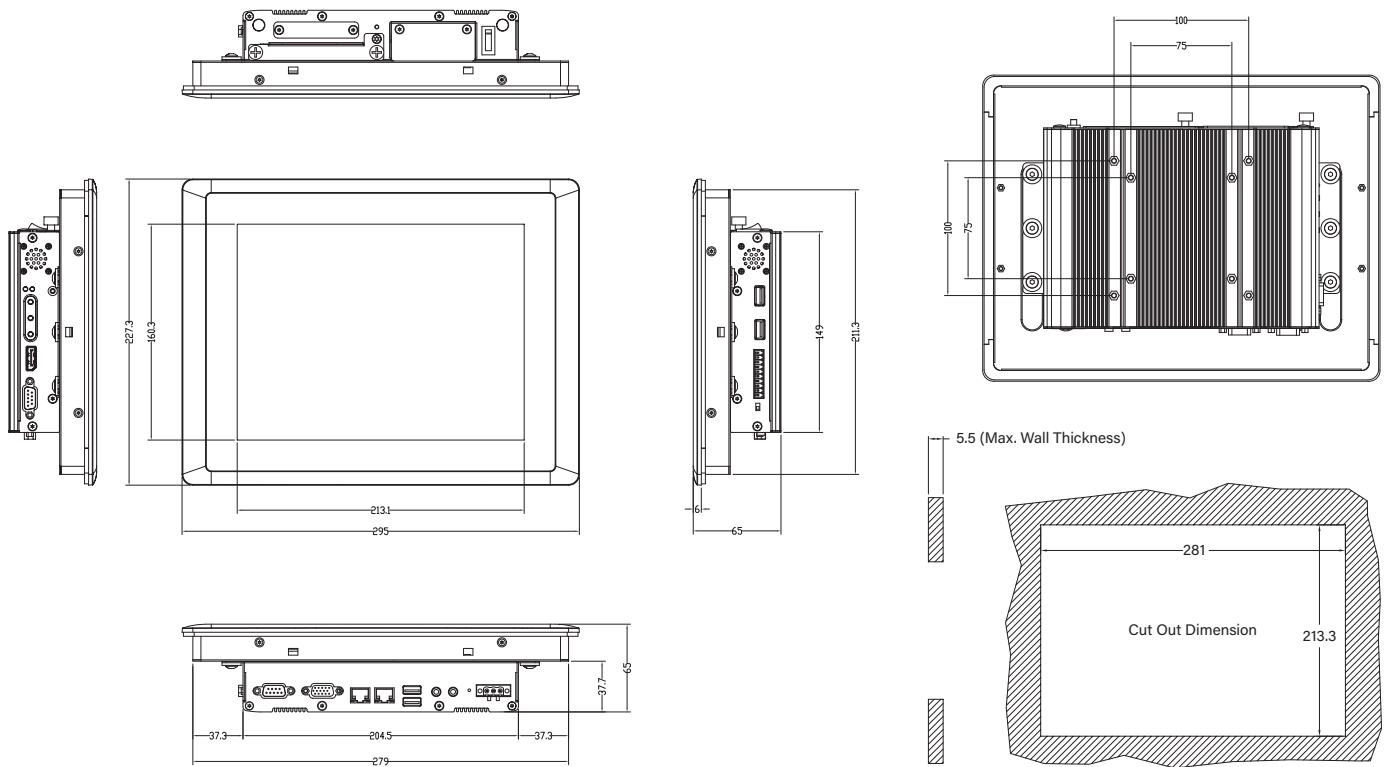

CS-110H/P1001E Dimensions

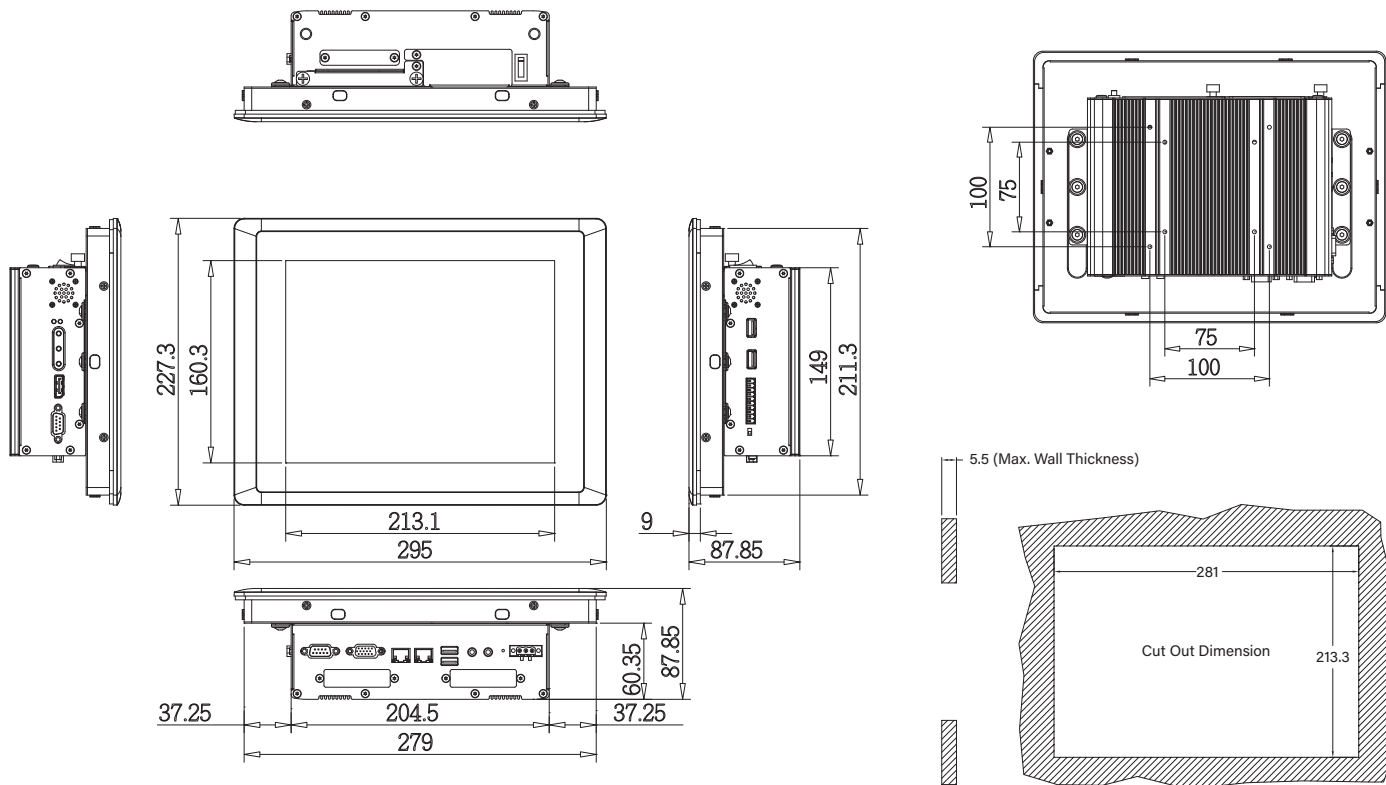

Ordering Information

Available Models

Model No.	Description
CS-110HC-R11/P1001-R10	10.4" TFT-LCD 1500 nits Sunlight Readable Touch Panel PC with Intel® Atom™ E3845 Quad Core Processor and P-Cap. Touch
CS-110HC-R11/P1001E-R10	10.4" TFT-LCD 1500 nits Sunlight Readable Touch Panel PC with Intel® Atom™ E3845 Quad Core Processor, P-Cap. Touch and 2x Universal I/O Bracket

Model Configuration

	CS-110HC	P1001	P1001E
CS-110HC/P1001	V	V	--
CS-110HC/P1001E	V	--	V

V : Compatible

Package Checklist



• CS-110H/P1001 Series Panel PC x 1	• Power Terminal Block Connector (Female) x 1
• Panel Mounting Kit x 1	• HDD Screw Pack x 1
• DIO Terminal Block Connector (Female) x 1	• Mini PCIe Screw Pack x 1

Optional Modules and Accessories

Model No.	Description
MEC-COM-M212-DB9	Mini-PCIe Module with 2x COM Ports, 1x Standard DB9 Cable (For P1001E only)
MEC-LAN-M102-30	Mini-PCIe Module with 2x LAN Ports, 2x 30cm cable (For P1001E only)
MEC-USB-M102-30	Mini-PCIe Module with 2x USB 3.2 Gen1 Ports, 1x 30cm cable (For P1001E only)
UB0303	2x Universal Bracket each with 1x DB9 Cutout (For P1001E only)
UB0311	1x Universal Bracket with 2x RJ45 Cutout (For P1001E only)
UB0314	1x Universal Bracket with 2x USB Cutout (For P1001E only)
URM01	Universal 19" Rack Mount Kit for Industrial Panel PC & Industrial Monitor
GST60A12-CIN1	Adapter AC/DC 12V 5A 60W, GST60A12-CIN1, wide temp (-30°C ~ +70°C)
SL2-SL3	US 2 heads power cord, US B type to IEC C13, SVT 18AWG/3C Black 1.8M SL-2+SL-3
SL6-SL3	EU 2 heads power cord, EU G type to IEC C13, H05VV-F 0.75mm2/3G Black 1.8M SL-6+SL-3
QP026-SL3	UK 2 heads power cord, UK I type to IEC C13, H05VV-F 0.75mm2/3G Black 1.8M QP026+SL-3

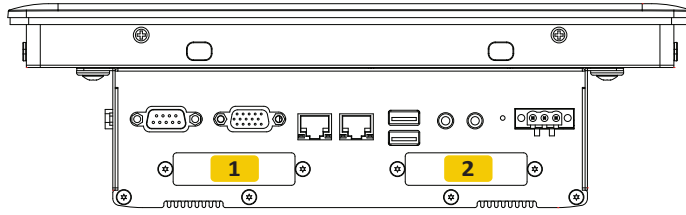
Optional Module Configuration (For P1001E only)

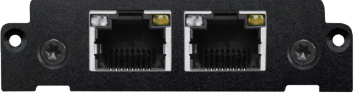

Model No.	Description	1	2
 <p>MEC-COM-M212-DB9/UB0303</p>	Mini-PCle Module with 2x COM Ports, 1x Standard DB9 Cable, 2x Universal Bracket each with 1x DB9 Cutout	V	V
 <p>MEC-LAN-M102-30/UB0311</p>	Mini-PCle Module with 2x LAN Ports, 2x 30cm cable, w/ 1x Universal Bracket with 2x RJ45 Cutout	V	V
 <p>MEC-USB-M102-30/UB0314</p>	Mini-PCle Module with 2x USB 3.2 Gen1 Ports, 1x 30cm cable, 1x Universal Bracket with 2x USB Cutout	V	V

V : Compatible