

User Manual

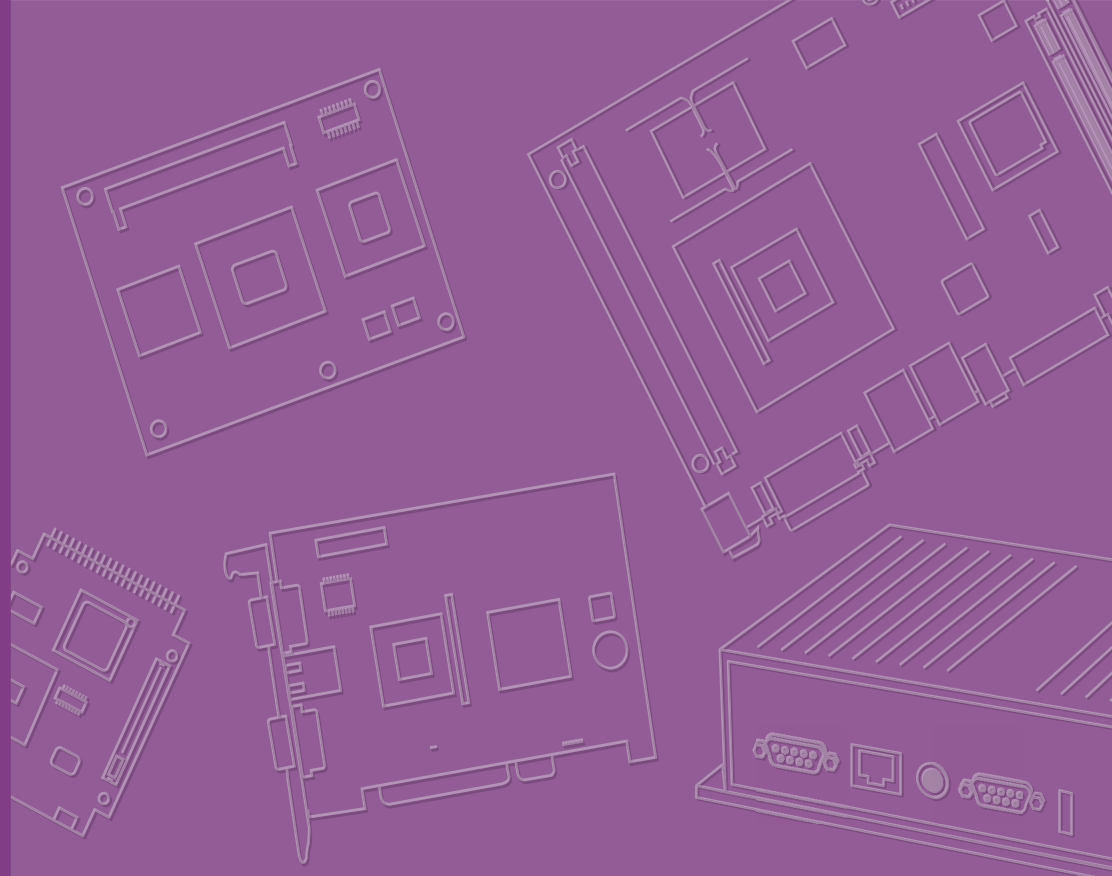

IDS-3315 Series

15" Industrial Front IP65 Monitor

ADVANTECH

Enabling an Intelligent Planet

Copyright

The documentation and the software included with this product are copyrighted 2018 by Advantech Co., Ltd. All rights are reserved. Advantech Co., Ltd. reserves the right to improve the products described in this manual at any time without notice. No part of this manual may be reproduced, copied, translated, or transmitted in any form, or by any means, without the prior written permission of Advantech Co., Ltd. The information provided in this manual is intended to be accurate and reliable. However, Advantech Co., Ltd. assumes no responsibility for its use, nor for any infringements of the rights of third parties that may result from its use.

Acknowledgements

Intel and Pentium are trademarks of Intel Corporation.

Microsoft Windows and MS-DOS are registered trademarks of Microsoft Corp.

All other product names or trademarks are properties of their respective owners.

Product Warranty (2 years)

Advantech warrants the original purchaser that all of its products will be free from defects in materials and workmanship for two years from the date of purchase.

This warranty does not apply to any products that have been repaired or altered by persons other than repair personnel authorized by Advantech, or products that have been subject to misuse, abuse, accident, or improper installation. Under the terms of this warranty, Advantech assumes no liability for the consequence of such events.

Because of Advantech's high quality-control standards and rigorous testing, most customers never need to use our repair service. If an Advantech product is defective, it will be repaired or replaced free of charge during the warranty period. For out-of-warranty repairs, customers will be billed according to the cost of the replacement materials, service time, and freight. Please consult your dealer for more details.

If you suspect that your product is defective, follow the steps outlined below.

1. Collect all the information about the problem encountered. (For example, CPU speed, Advantech products used, other hardware and software used, etc.) Note anything abnormal and list any onscreen messages displayed when the problem occurs.
2. Call your dealer and describe the problem. Please have your manual, product, and all relevant information readily available.
3. If your product is diagnosed as defective, obtain a return merchandise authorization (RMA) number from your dealer. This allows us to process your return more quickly.
4. Carefully pack the defective product, a completed Repair and Replacement Order Card, and a proof of purchase date (such as a photocopy of your sales receipt) in a shippable container. Products returned without a proof of purchase date are not eligible for warranty service.
5. Write the RMA number clearly on the outside of the package and ship it prepaid to your dealer.

Declaration of Conformity

CE

This product has passed the CE test for environmental specifications. Test conditions for passing included the equipment being operated within an industrial enclosure. In order to protect the product from damage due to electrostatic discharge (ESD) or electromagnetic interference (EMI) leakage, we strongly recommend the use of CE-compliant industrial enclosure products.

FCC Class A

This equipment has been tested and found to comply with the limits for a Class A digital device, pursuant to part 15 of the FCC Rules. These limits are designed to provide reasonable protection against harmful interference when the equipment is operated in a commercial environment. This equipment generates, uses, and can radiate radio frequency energy and, if not installed and used in accordance with the instruction manual, may cause harmful interference to radio communications. Operation of this equipment in a residential area is likely to cause harmful interference. In such cases, users are required to correct the interference at their own expense.

Technical Support and Assistance

1. Visit the Advantech website at <http://support.advantech.com> to obtain the latest product information.
2. Contact your distributor, sales representative, or Advantech's customer service center for technical support or additional assistance. Please have the following information ready before calling:
 - Product name and serial number
 - Description of your peripheral attachments
 - Description of your software (operating system, version, application software, etc.)
 - Comprehensive description of the problem
 - The exact wording of any error messages

Warnings, Cautions, and Notes

Warning! Warnings indicate conditions that if not observed can result in personal injury!



Caution! Cautions are included to prevent hardware damage or data losses.



New batteries are at risk of exploding if incorrectly installed. Do not attempt to recharge, force open, or heat the battery. Replace the battery only with the same or equivalent type recommended by the manufacturer. Discard used batteries according to the manufacturer's instructions.

Note! Notes provide additional optional information.



Document Feedback

To assist us in improving this manual, we welcome all comments and constructive criticism. Please send all feedback in writing to support@advantech.com

Safety Instructions

1. Read these safety instructions carefully.
2. Retain this user manual for future reference.
3. Disconnect this equipment from all AC outlets before cleaning. Use a damp cloth to clean the equipment. Do not use liquid or spray detergents.
4. For plugable equipment, the power outlet socket should be located near the equipment and easily accessible.
5. Protect the equipment from humidity.
6. Place this equipment on a reliable surface during installation. Dropping or letting the equipment fall may cause damage.
7. The openings of the enclosure are for air convection. Prevent the equipment from overheating. Do not cover the openings.
8. Ensure that the voltage is correct before connecting the equipment to a power outlet.
9. Position the power cord away from high-traffic areas. Do not place anything over the power cord.
10. All cautions and warnings on the equipment should be noted.
11. If idle for a long duration, disconnect the equipment from the power source to avoid damage from transient overvoltage.
12. Never pour liquid into an opening. This may cause fire or electrical shock.
13. Never open the equipment. For safety reasons, the equipment should only be opened by qualified service personnel.
14. If one of the following occurs, have the equipment checked by service personnel:
 - The power cord or plug is damaged.
 - Liquid has penetrated into the equipment.
 - The equipment has been exposed to moisture.
 - The equipment is malfunctioning or does not function according to the user manual.
 - The equipment has been dropped or damaged.
 - The equipment shows obvious signs of breakage.
15. Do not store this equipment in an environment where the temperature fluctuates below $-20\text{ }^{\circ}\text{C}$ ($-4\text{ }^{\circ}\text{F}$) or above $60\text{ }^{\circ}\text{C}$ ($140\text{ }^{\circ}\text{F}$) because this could damage the equipment. The equipment should be stored in a controlled environment.
16. The sound pressure level at the operator's position does not exceed 70 dB (A) in accordance with IEC 704-1:1982.

DISCLAIMER: These instructions are provided according to IEC 704-1. Advantech disclaims all responsibility for the accuracy of any statements contained herein.

Caution! *Information regarding the adapter output rating (12 V_{DC}, 5 A/18 W min) is provided in the user manual to assist with adaptor selection if a power adapter is not shipped with the unit.*



Contents

Chapter 1	Overview	1
1.1	Introduction	2
1.2	Features	2
1.3	Applications	2
1.4	Product Photos	2
1.5	Naming Rule	3
Chapter 2	System Setup	5
2.1	Specifications	6
2.2	Rear Mount Assembly	7
2.3	Packing List	7
Chapter 3	Touchscreen	9
3.1	OSD Functions	10
3.2	OSD Menu Details	11
3.2.1	Luminance	11
3.2.2	Image Setup	12
3.2.3	Color Temperature	14
3.2.4	OSD Setup	15
3.2.5	Extra	16
3.3	Touch Drivers	19
Appendix A	Troubleshooting	21
A.1	Introduction	22
A.2	Troubleshooting	22

Chapter 1

Overview

- Introduction
- Features
- Applications
- Product Photos
- Naming Rule

1.1 Introduction

Advantech's IDS-3315 series is a brand new Industrial front IP65 Monitor, designed for waterproof and dustproof at the front side for different applications, such as public signage, front of house information, medical, and point-of-sale.

1.2 Features

- 15" XGA LED backlight panel which provides 20~30% power saving
- -20°C ~ +60°C wide operating temperature range support
- Front IP65 for waterproof and dustproof
- Design with 5-wire resistive and P-cap touchscreen (optional)
- Versatile mounting methods for rear mount and VESA mount (75 x 75 mm, 100 x 100 mm)

1.3 Applications

Application scenarios

- KIOSK / POI machine
- Transportation machine
- Ticketing machine
- Financial ATM
- Entertainment / gaming / slot machine
- Human-Machine Interface equipment controller monitor
- Public communication machine
- Public advertisement machine

1.4 Product Photos

Front View



1.5 Naming Rule

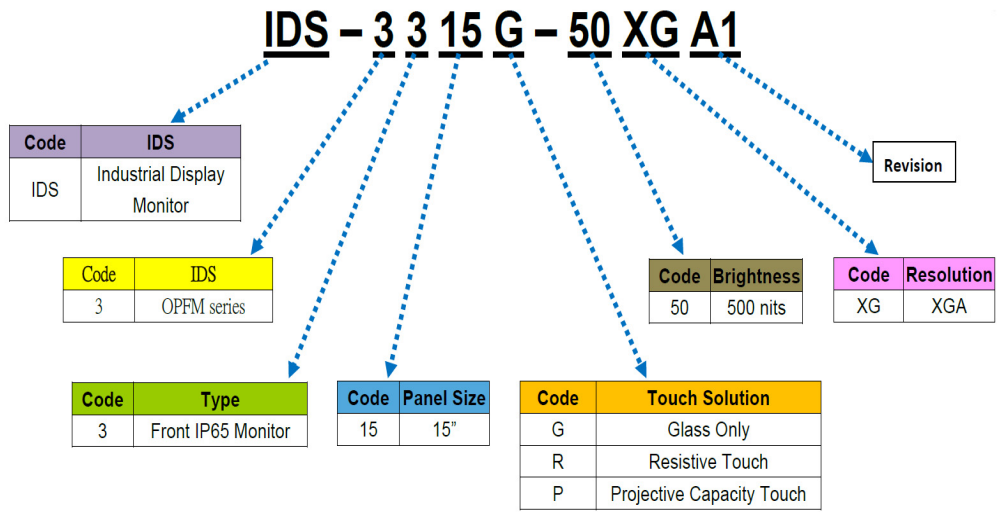

Chapter 2

System Setup

- Specifications
- Dimensions
- Rear Mount Assembly
- Cable Clamp
- Packing List

2.6 Specifications

Note! The IDS-3315 offers the following features.



Unless otherwise indicated, all the specifications listed below are subject to change without prior notification.

Display	Model	IDS-3315
	Size	15" LED panel
	Resolution	1024 x 768 (XGA)
	Viewing Angle	88°/88° (H), 88°/88° (V)
	Brightness	500 (cd/m ²)
	Color Support	16.7M/262K
	Contrast Ratio	2500:1
	Response Time	16 [msec]
	Backlight Life (hrs)	50,000 hrs
Touchscreen	Touchscreen Type	5-Wire Resistive Touchscreen / Projected Capacitive Touchscreen
	Surface Hardness	3H / Mohs 5
	Durability	10 million touches / -
	Transparency	80% / 89 ± 3%
Environment	Operating Temperature	-20 ~ 60° C (-4 ~ 140° F)
	Storage Temperature	-30 ~ 70° C (-22 ~ 158° F)
	Humidity	5 ~ 95% @ 40° C, non-condensing
	Vibration	5-500 Hz, 0.026G ² /Hz, 2.16Grms, X, Y, Z 1 hour per axis
System	I/O	VGA x 1, DVI x 1, HDMI x 1, 12V DC Jack x 1, USB x 1, RS232 x 1 (RS232 and USB are reserved for the connection to enable touch usage only)
	OSD	Keys: Power on/off, Menu/Enter, Left/Up, Right/Down, Exit/Auto, Source Menu Functions: Brightness, Contrast, Screen Setting, Color Temp, OSD Language, Reset, Auto Adjust
	Power	60 W power adapter, with AC 100 ~ 240 V input and DC +12 V @ 5 A output
	EMC Compliance	CE/FCC/CCC

2.7 Rear Mount Assembly

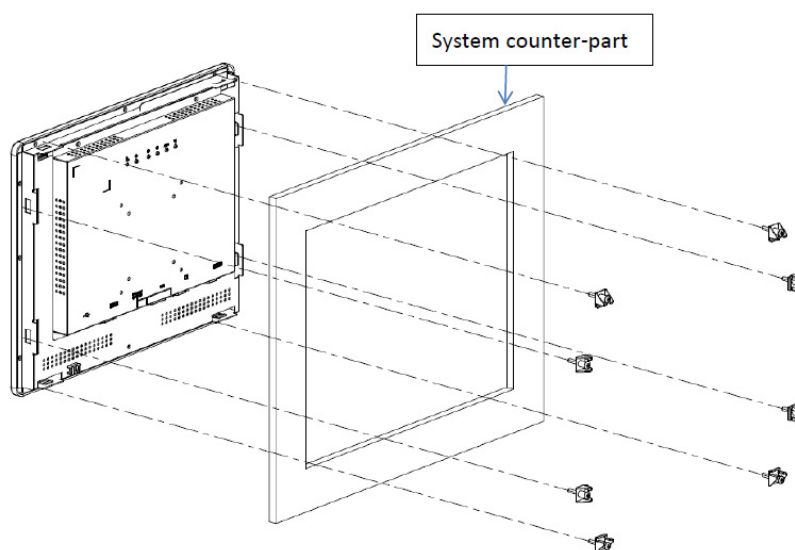

Note! Suggested screws - M4x10L



2.8 Packing List

- 1 x VGA cable 15P(M) 1.8 meter
- 1 x USB-A(M)/USB-A(M) 1.8 meter
- 8 x Panel-mount clamps
- 8 x Panel-mount clamber screws: M4_25L
- 1 x Cable clamp
- 1 x Cable clamp screw
- 1 x Cable tie
- 1 x 60 W DC12V Power Adapter (optional order)
- 1 x Power Cord (optional order)
- 1 x DVI cable 2.0 meter (optional order)
- 1 x RS232 9P/9P 1.8M M/F cable (optional order)

Note! The accessory cables listed above may differ according to SKU.



Chapter 3

Touchscreen

- OSD Functions
- Touch Drivers

3.1 OSD Functions

IDS-3315 is equipped with 1024 x 768 display resolution and the following OSD features:

Buttons	Description
Power	Turn the monitor power ON or OFF
Menu	Activate the OSD menu Select
Auto/Exit	Automatically adjust the clock, phase H-position and V-position
Value Up/Down	Move the selector to the previous option Reduce the value of the selected option

LED Function

DPMS ON	Green
DPMS STANDBY	Orange
DPMS OFF	Red

Hot Key	Function
Value Down	ECO mode

3.2 OSD Menu Details

3.2.1 Luminance

Contrast

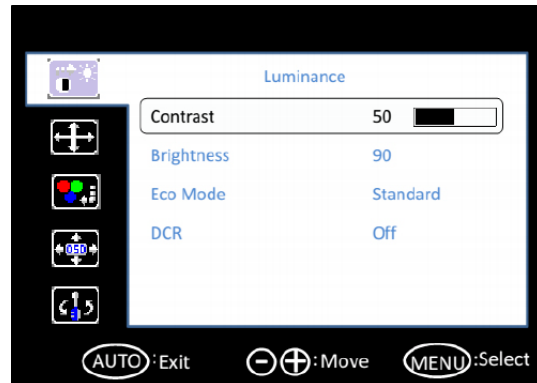
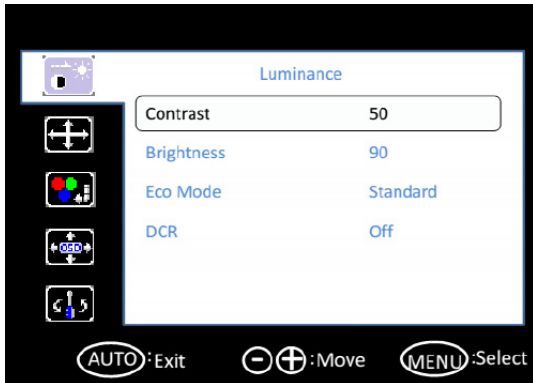

Brightness

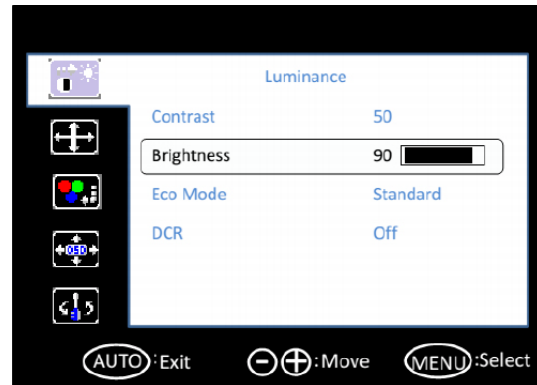
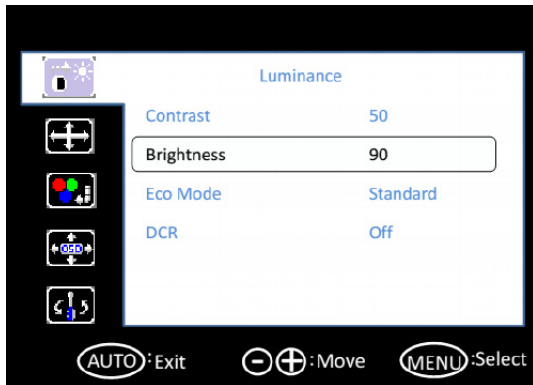

Eco Mode

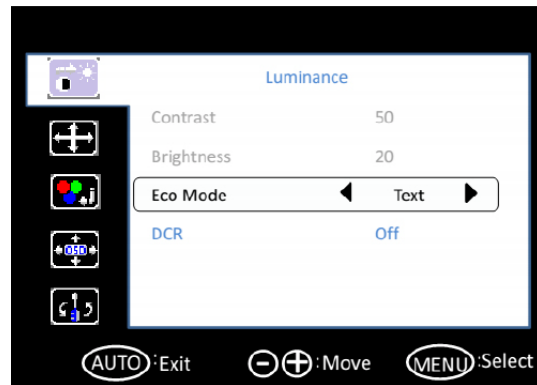
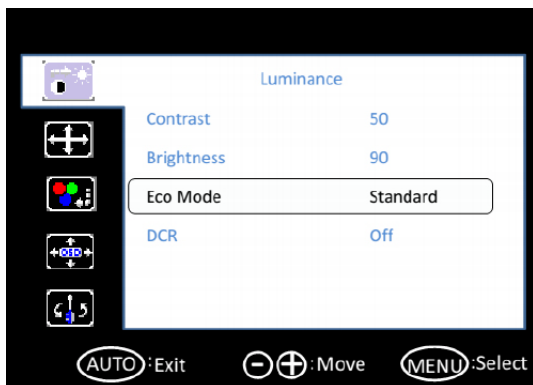

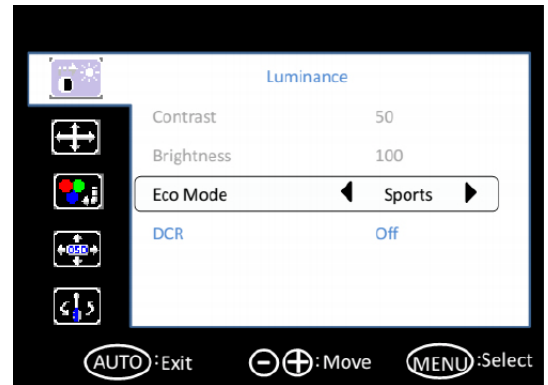
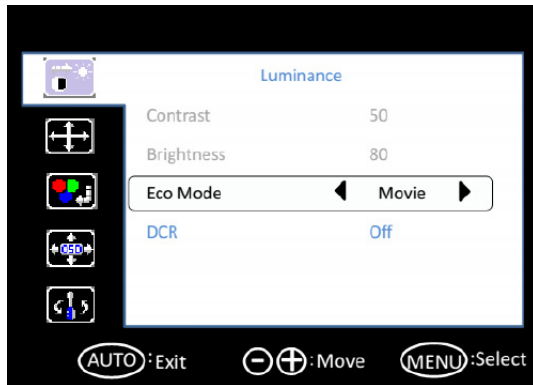
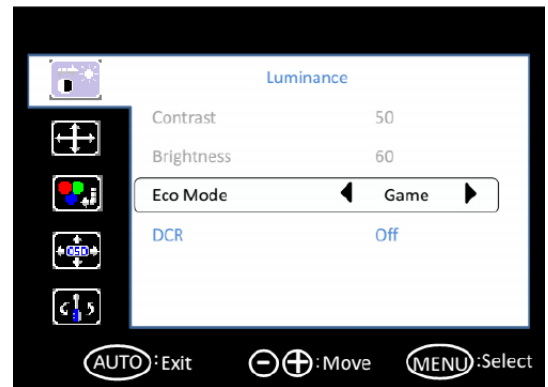
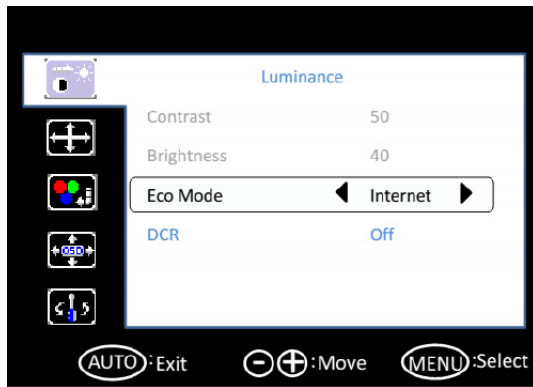

DCR

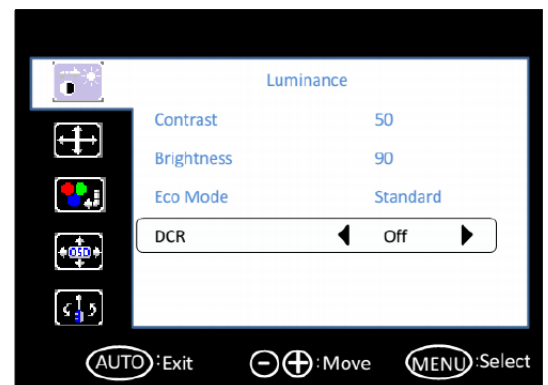
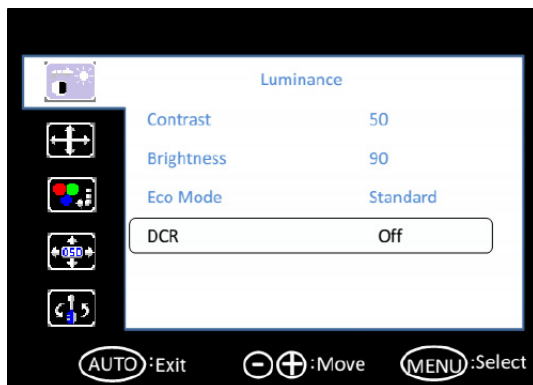

3.2.2 Image Setup

Clock

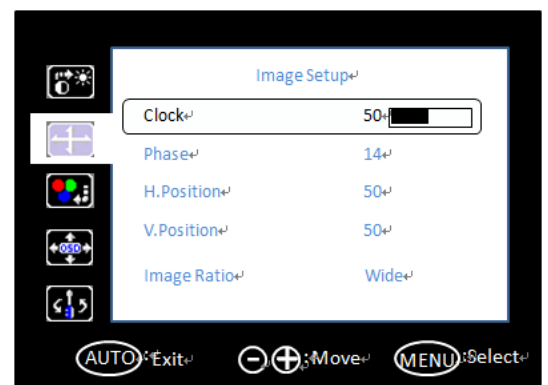
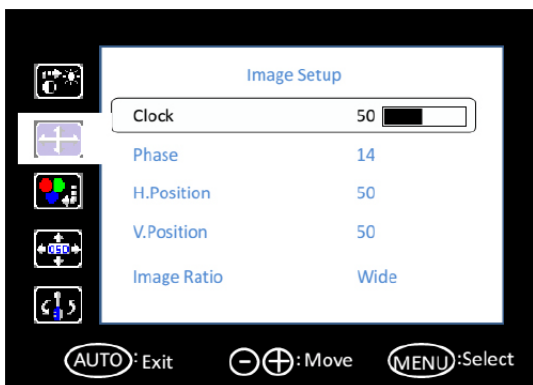

Phase

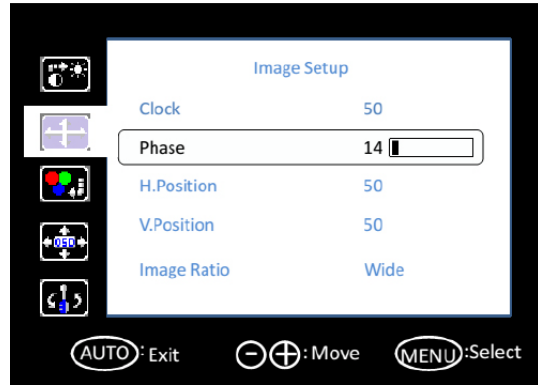
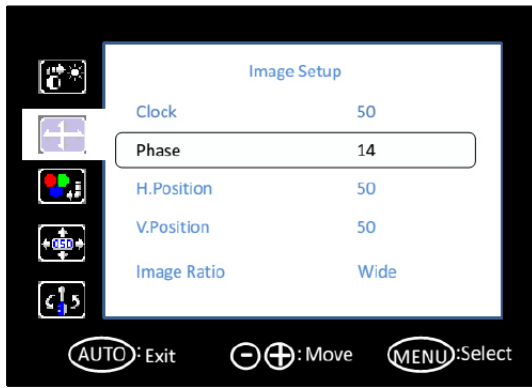

H. Position

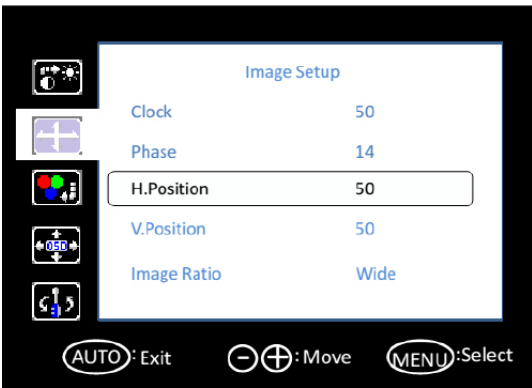

V. Position

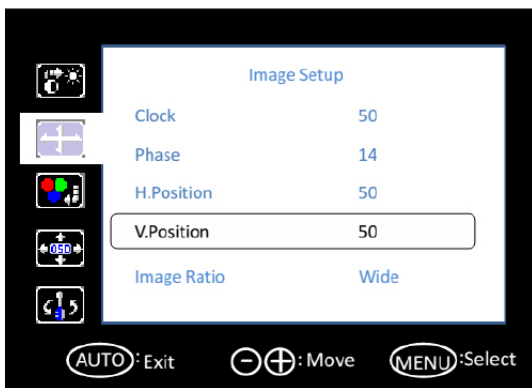
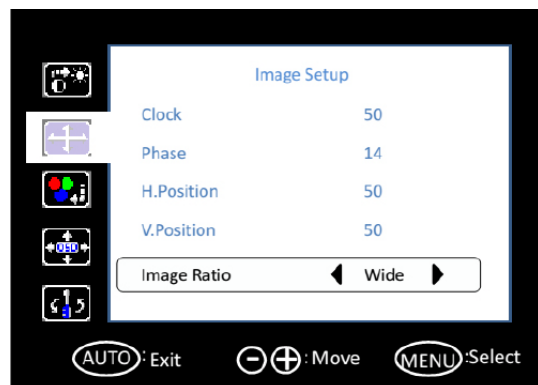
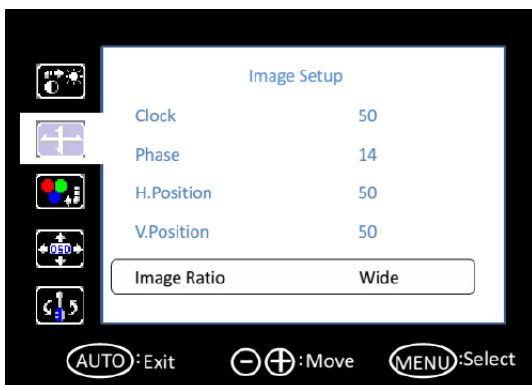
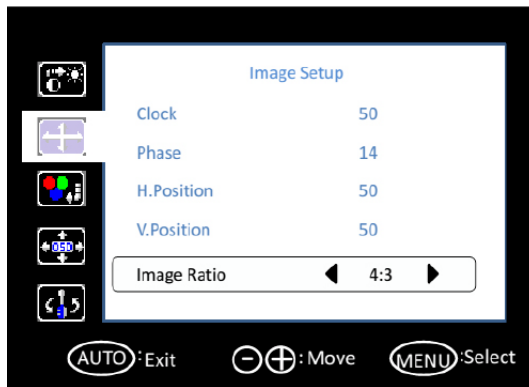

Image Ratio





3.2.3 Color Temperature

Color Temperature

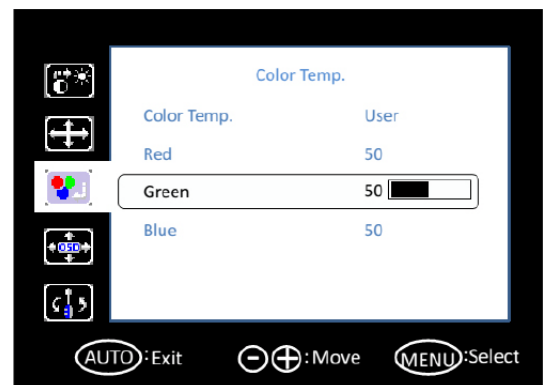
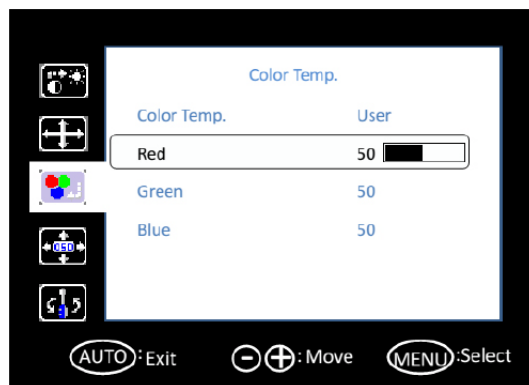
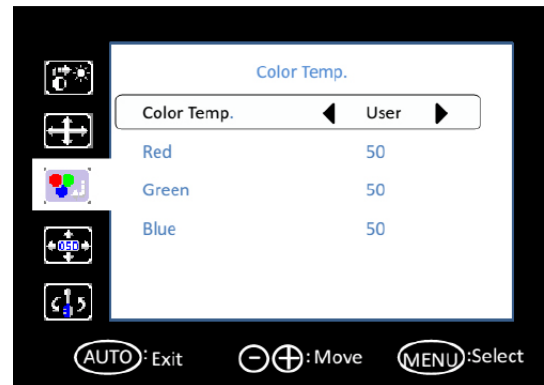
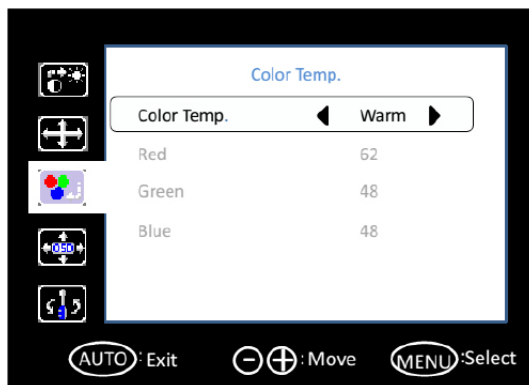
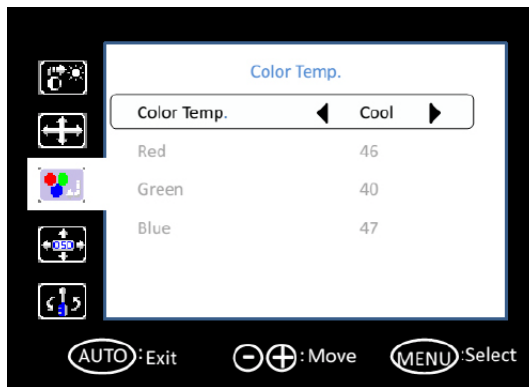

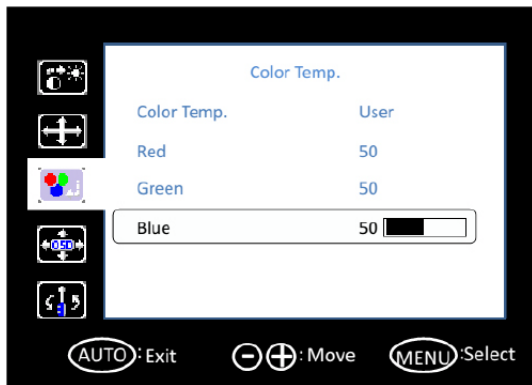

3.2.4 OSD Setup

H. Position

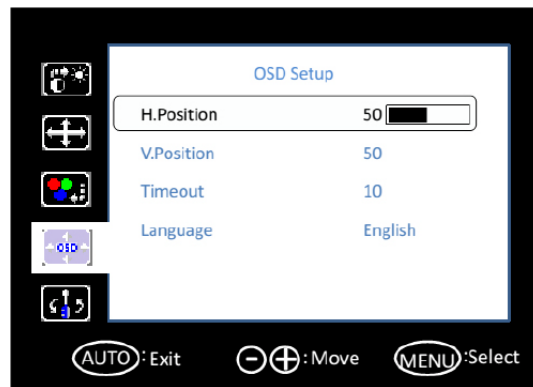
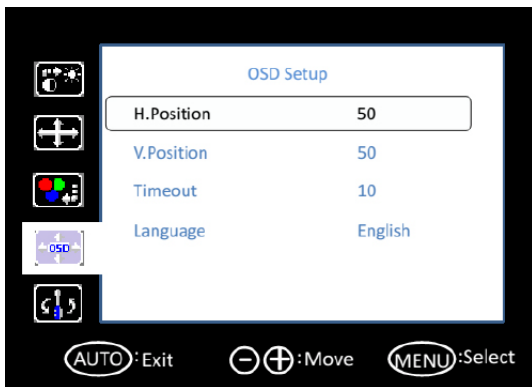

V. Position

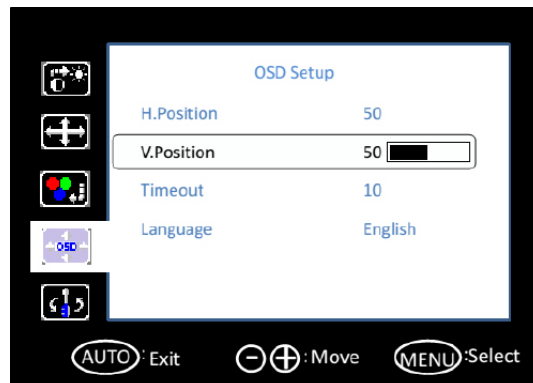
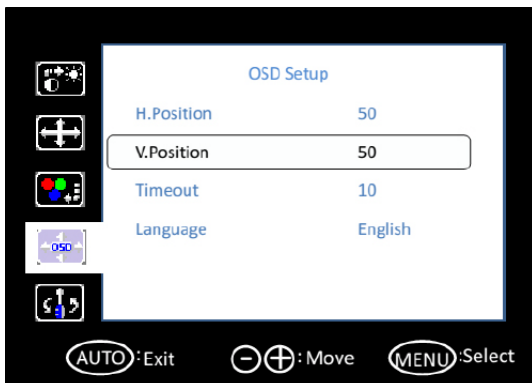

Timeout

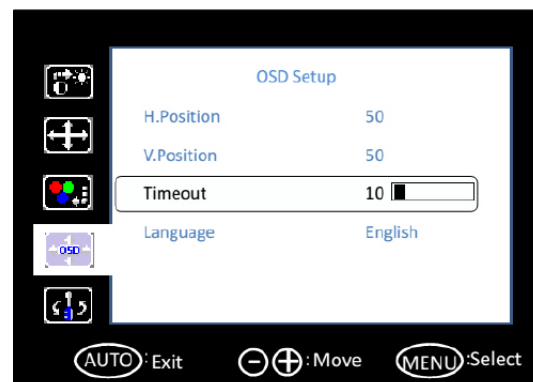
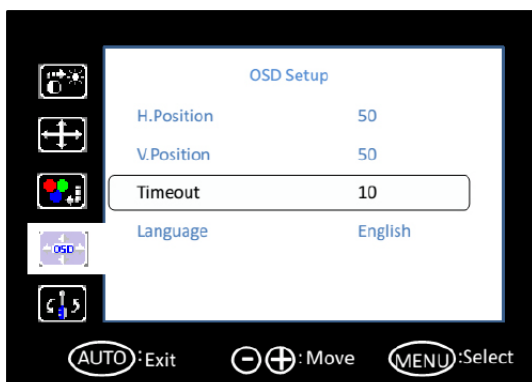

Language



3.2.5 Extra

Input Select

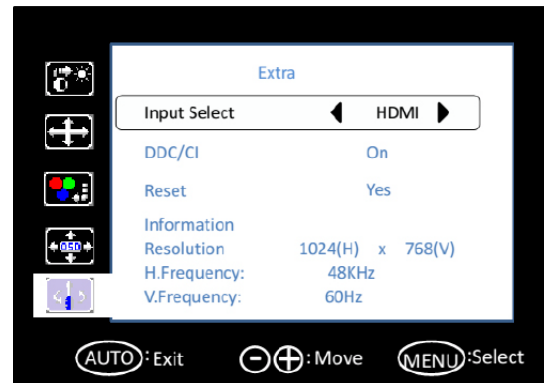
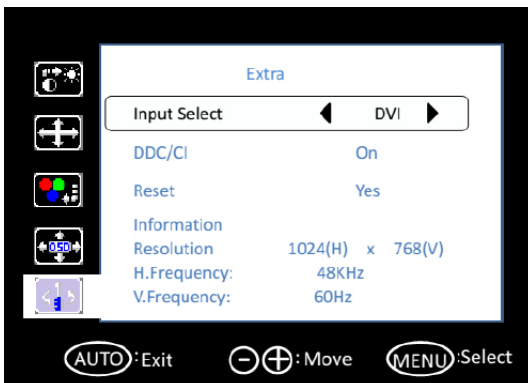
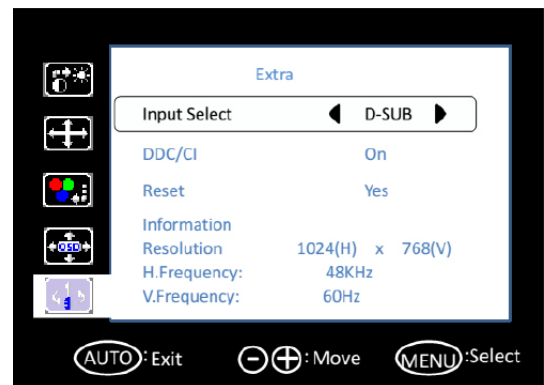
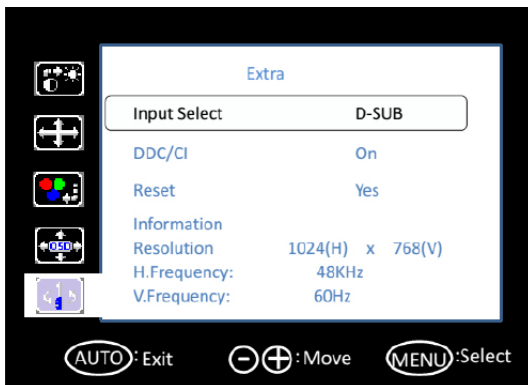

DDC/CI

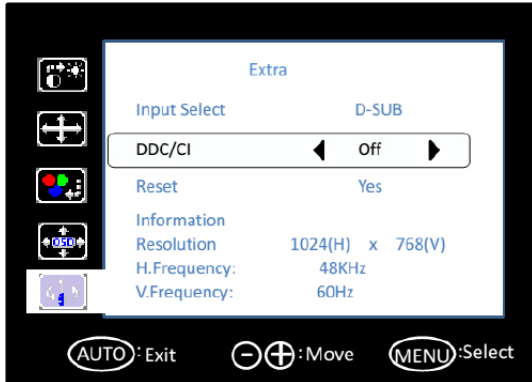
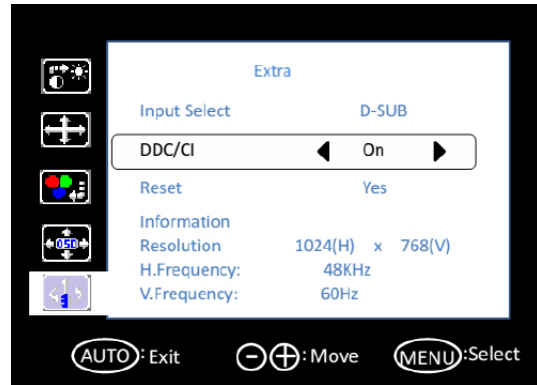
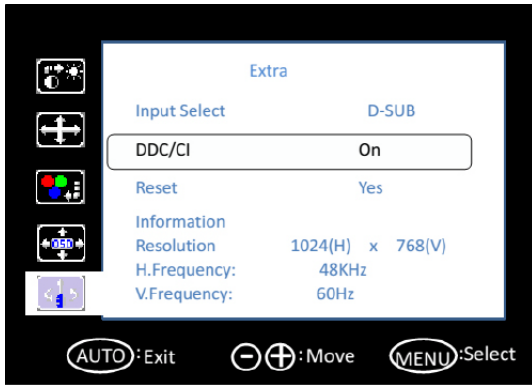

Reset

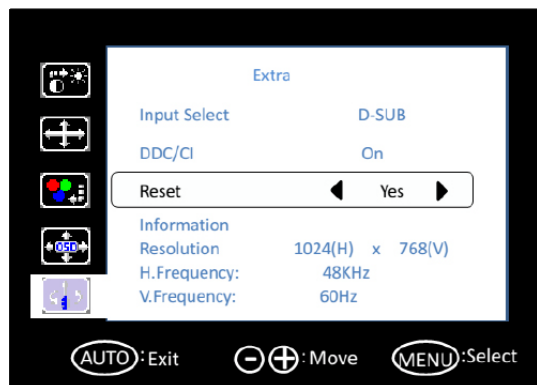
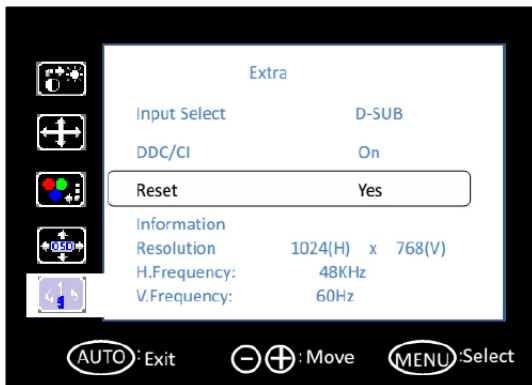

Layer 1	Layer 2	Layer 3	Comment	Default Value
Luminance	Contrast	0	Adjusts contrast	50
		100		
	Brightness	0	Adjusts brightness (backlight)	90
		100		
	ECO Mode	Standard		Standard
		Sport		
		Movie		
		Game		
		Internet		
		Text		
DCR	On	Sets dynamic contrast ratio	Off	
	Off			
Image setup	Clock	0	Adjusts clock latency of output capture window	Depends on the input resolution
		100		
	Phase	0	Adjusts clock phase of output capture window	Depends on the input resolution
		100		
	H. Position	0	Adjusts horizontal position of output capture window	50
		100		
V. Position	0	Adjusts vertical position of output capture window	50	
	100			
Image Ratio	Wide	Adjusts aspect ratio to full screen	Wide	
	4:3	Adjusts aspect ratio to 4:3 screen		
Color Temperature	Color Temp.	Warm -->	Adjusts color temperature to warm	User
		Normal -->	Adjusts color temperature to normal	
		Cool -->	Adjusts color temperature to cool	
		User -->	Adjusts color temperature to user defined	
OSD Setup	H. Position	0	Adjusts OSD horizontal position	50
		100		
	V. Position	0	Adjusts OSD vertical position	50
		100		
	Timeout	5	Sets OSD timeout counter	10
		100		
Language	English	Sets OSD display language	English	
	Spanish			
	French			
	Portuguese			
	Russian			
	简体中文			
	繁體中文			
	Korean			

Extra	Input Select	D-Sub	Sets input source	Depends on the input source
		HDMI		
		DVI		
	DDC/CI	On	Sets DDC/CI function on/off	On
Off				
Reset	Yes	Sets user setting reset	On	
	No			
Information	Resolution	Display current source information	Depends on the input source	
	H. Frequency			
	V. Frequency			

3.3 Touch Drivers

The touchscreen driver is available online at the Advantech website. Use the following link to access the driver: <http://support.advantech.com/support/default.aspx>

Appendix **A**

Troubleshooting

A.1 Introduction

If the monitor is malfunctioning or does not operate according to the user manual, refer to the following instructions before calling the Advantech service center.

If you are unable to correct the faults using the instructions provided below, please contact your distributor or the Advantech service center.

A.2 Troubleshooting

The image is displayed incorrectly/the full screen image does not appear

- Ensure that the screen resolution on the motherboard is correct.

The screen image is not centered

- Adjust the horizontal and vertical position of the OSD or select the “Auto” option for automatic adjustment.

Out of range

- If an “Out of Range” message appears onscreen, this indicates that the display output signal is not compatible with the LCD display (for example, the output resolution exceeds the LCD display resolution).
- Adjust the BIOS settings to match the correct resolution.

No signal

- The display is powered on but is not receiving or displaying output signals from the computer. Check all power switches, power cables, and VGA signal cables and ensure that both ends of all cables are properly connected.

Going to sleep

- If the system goes to sleep, either the display has been set to power-saving mode or is experiencing a sudden signal disconnection problem. Check the BIOS system settings and/or Windows configuration. Then check both ends of the power cable connected to the computer.

ADVANTECH

Enabling an Intelligent Planet

www.advantech.com

Please verify specifications before quoting. This guide is intended for reference purposes only.

All product specifications are subject to change without notice.

No part of this publication may be reproduced in any form or by any means, such as electronically, by photocopying, recording, or otherwise, without prior written permission from the publisher.

All brand and product names are trademarks or registered trademarks of their respective companies.

© Advantech Co., Ltd. 2018