



**HIRSCHMANN**

A **BELDEN** BRAND

# User Manual

## Installation

### Industrial ETHERNET Workgroup Switch

### MACH 100 Family



MACH 102-8TP-F

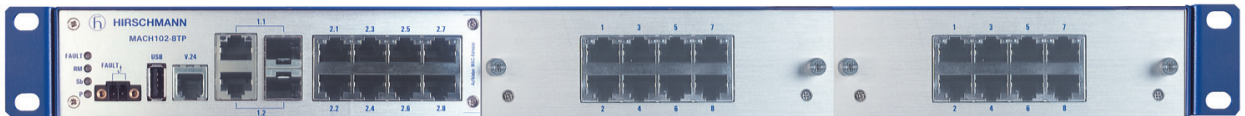

MACH 102-24TP-F

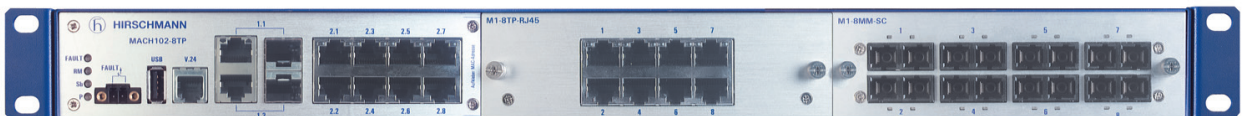

MACH 102-8TP + M1-8TP-RJ45 + M1-8MM-SXC



MACH 102-8TP + M1-8SM-SXC + M1-8SFP



039710001030709000

The naming of copyrighted trademarks in this manual, even when not specially indicated, should not be taken to mean that these names may be considered as free in the sense of the trademark and tradename protection law and hence that they may be freely used by anyone.

© 2009 Hirschmann Automation and Control GmbH

Manuals and software are protected by copyright. All rights reserved. The copying, reproduction, translation, conversion into any electronic medium or machine scannable form is not permitted, either in whole or in part. An exception is the preparation of a backup copy of the software for your own use. For devices with embedded software, the end-user license agreement on the enclosed CD applies.

The performance features described here are binding only if they have been expressly agreed when the contract was made. This document was produced by Hirschmann Automation and Control GmbH according to the best of the company's knowledge. Hirschmann reserves the right to change the contents of this document without prior notice. Hirschmann can give no guarantee in respect of the correctness or accuracy of the information in this document.

Hirschmann can accept no responsibility for damages, resulting from the use of the network components or the associated operating software. In addition, we refer to the conditions of use specified in the license contract.

You can get the latest version of this manual on the Internet at the Hirschmann product site ([www.hirschmann-ac.de](http://www.hirschmann-ac.de)).

Printed in Germany  
Hirschmann Automation and Control GmbH  
Stuttgarter Str. 45-51  
72654 Neckartenzlingen  
Germany  
Tel.: +49 1805 141538

# Content

<b>Safety instructions</b>	<b>5</b>
<b>About this manual</b>	<b>10</b>
<b>Legend</b>	<b>10</b>
<b>1 Device description</b>	<b>11</b>
1.1 Description of the device variants	12
1.1.1 MACH 100 basic device	12
1.1.2 MACH 100 media modules	16
1.1.3 SFP modules	18
<b>2 Assembly and start-up</b>	<b>20</b>
2.1 Installing the device	20
2.1.1 Unpacking and checking	20
2.1.2 Installing the media modules	20
2.1.3 Installing the SFP modules	21
2.1.4 Signal contact „FAULT“	22
2.1.5 Dimension drawings	23
2.1.6 Installing the device and grounding	24
2.1.7 Supply voltage	27
2.1.8 Startup procedure	28
2.1.9 Installing the data lines	28
2.2 Display elements	30
2.3 Making basic settings	32
2.4 Disassembly	34
<b>3 Technical data</b>	<b>35</b>
<b>Weitere Unterstützung</b>	<b>41</b>



# Safety instructions

This documentation contains instructions which must be observed to ensure your own personal safety and to avoid damage to devices and machinery.

## ■ Certified usage

Please observe the following: The device may only be employed for the purposes described in the catalog and technical description, and only in conjunction with external devices and components recommended or approved by the manufacturer. The product can only be operated correctly and safely if it is transported, stored, installed and assembled properly and correctly. Furthermore, it must be operated and serviced carefully.

## ■ Supply voltage

The supply voltage is electrically isolated from the housing.

- Use only undamaged parts.
- The device does not contain any service components. Internal fuses are only triggered if there is a fault in the device. If the device is not functioning correctly, or if it is damaged, switch off the voltage supply and return the device to the plant for inspection.
- Only switch on the device when the housing is closed.
- Only use connection cables that are permitted for the specified temperature range.
- Relevant for North America:  
Only use copper wire/conductors of class 1, 60/75°C or 75°C.



### **Warning!**

Only connect a supply voltage that corresponds to the type plate of your device.



**Warning:** Install an input fuse in the ungrounded voltage cables for every voltage supply connection. For the AC input of the AC/DC power units, use a nominal rating of 3 A, characteristic B.

- Make sure that the disconnecting device is easily accessible so that the MACH 100 device can be disconnected from the main voltage. If you disconnect the device from the main voltage using
  - the plug in the socket
  - an on/off switchit must be easily accessible.

**Note:** For devices with redundant voltage supply (MACH 102-8TP-R, MACH 102-8TP-FR, MACH 102-24TP-FR), both non-heating appliance plugs must be pulled to disconnect the device from the main voltage.

### ■ **Shielding ground**

The shielding ground of the connectable twisted pair lines is connected to the protective conductor connection via the front panel.

- Beware of possible short circuits when connecting a cable section with conductive shielding braiding.

### ■ **Housing**

Only technicians authorized by Hirschmann are permitted to open the housing.

The device is grounded via the voltage supply socket.

- Make sure that the electrical installation meets local or nationally applicable safety regulations.
- The ventilation slits must not be covered so as to ensure free air circulation.
- The clearance to the ventilation slits of the housing must be at least 10 cm (3.94 in).



#### **Warning!**

Never insert sharp objects (small screwdrivers, wires, etc.) into the inside of the product. There is the risk of an electric shock.

- Close all empty slots with a covering panel.
- The device must be installed in the horizontal or upright position, either as a table unit in the switch cabinet (see fig. 15) or on the wall (see fig. 16).
- If you are operating the device in a 19" switch cabinet: install sliding/mounting rails for holding the device (see fig. 14).

### ■ **Environment**

The device may only be operated at the specified maximum ambient temperature (temperature of the surrounding air at a distance of up to 5 cm (1.97 in) to the device) and relative air humidity (non-condensing).

- Install the device in a location where the climatic threshold values specified in the technical data are adhered to.
- Only to be used in an environment with the pollution degree specified in the technical data.

## ■ **Qualification requirements for personnel**

Qualified personnel as understood in this manual and the warning signs, are persons who are familiar with the setup, assembly, startup, and operation of this product and are appropriately qualified for their job. This includes, for example, those persons who have been:

- ▶ trained or directed or authorized to switch on and off, to ground and to label power circuits and devices or systems in accordance with current safety engineering standards;
- ▶ trained or directed in the care and use of appropriate safety equipment in accordance with the current standards of safety engineering;
- ▶ trained in providing first aid.

## ■ **General safety instructions**

Electricity is used to operate this equipment. Comply in every detail with the safety requirements specified in the operating instructions regarding the voltages to apply.

Non-observance of these safety instructions can therefore cause material damage and/or serious injuries.

- Only appropriately qualified personnel should work on this device or in its vicinity. These personnel must be thoroughly familiar with all the warnings and maintenance procedures in accordance with this operating manual.
- The proper and safe operation of this device depends on proper handling during transport, proper storage and assembly, and conscientious operation and maintenance procedures.
- Never start operation with damaged components.
- Only use the devices in accordance with this manual. In particular, observe all warnings and safety-related information.
- Any work that may be required on the electrical installation may only be carried out by personnel trained for this purpose.
  
- Please note that products recommended as accessories may have characteristics that do not fully correspond to those of the corresponding product. This may limit their possible usage in the overall system.

### **Note:**

LED or LASER components in compliance with IEC 60825-1 (2001):  
CLASS 1 LASER PRODUCT  
CLASS 1 LED PRODUCT

## ■ **National and international safety regulations**

- Make sure that the electrical installation meets local or nationally applicable safety regulations.

## ■ **ESD Guidelines**

The media modules are equipped with electrostatically sensitive components. These can be destroyed, or their life cycles reduced, by the effects of an electrical field or by a charge equalization if the card is touched. For this reason, the cards are packaged in a conductive ESD protective bag on delivery. The packaging can be reused.

Make sure you adhere to the following protection measures for electrostatically endangered assemblies:

- Create electrical equipotential bonding between yourself and your environment, e.g. using a wristband, which you clamp to the basic device (knurled screw of an interface card). When the power supply cable is connected, the basic device is grounded via the power supply connection.
- Only now do you take the card out of the conductive bag.
- Outside the basic device, only store the cards in a conductive ESD protective bag.

ESD protective field equipment is available for the safe handling of electrostatically endangered assemblies.

You can find more information about electrostatically endangered assemblies in DIN/IEC 47 (Sec) 1330; February 1994 Edition and DIN EN 100 015.

## ■ **Note on the CE marking**

The devices comply with the regulations contained in the following European directives:

2006/95/EG, 2004/108/EG

Directive of the European Parliament and the council for standardizing the regulations of member states with regard to electromagnetic compatibility.

In accordance with the above-named EU directives, the EU conformity declaration will be at the disposal of the relevant authorities at the following address:

Hirschmann Automation and Control GmbH  
Stuttgarter Strasse 45-51  
72654 Neckartenzlingen  
Tel.: +49 1805 141538

The product can be used in living areas (living area, place of business, small business) and in industrial areas.



- ▶ Interference immunity: EN 61000-6-2:2005
- ▶ Emitted interference: EN 55022:2006 Class A



### **Warning**

This is a class A device. This device can cause interference in living areas, and in this case the operator may be required to take appropriate measures.

The assembly guidelines provided in these instructions must be strictly adhered to in order to observe the EMC threshold values.

### ■ **FCC note:**

Appropriate testing has established that this device fulfills the requirements of a class A digital device in line with part 15 of the FCC regulations.

These requirements are designed to provide sufficient protection against interference when the device is being used in a business environment. The device creates and uses high frequencies and can radiate same, and if it is not installed and used in accordance with this operating manual, it can cause radio transmission interference. The use of this device in a living area can also cause interference, and in this case the user is obliged to cover the costs of removing the interference.

### ■ **Recycling note**

After usage, this product must be disposed of properly as electronic waste in accordance with the current disposal regulations of your county / state / country.

# About this manual

The following manuals are included as PDF files on the enclosed CD ROM:

- ▶ User manual „Installation“
- ▶ User manual “Basic configuration”
- ▶ User manual “Redundancy configuration”
- ▶ Reference manual “Web-based Interface” and
- ▶ Reference manual “Command Line Interface”

The Network Management Software HiVision/Industrial HiVision provides you with additional options for smooth configuration and monitoring:

- ▶ Configuration of multiple devices simultaneously.
- ▶ Graphical interface with network layouts.
- ▶ Auto-topology discovery.
- ▶ Event log.
- ▶ Event handling.
- ▶ Client / Server structure.
- ▶ Browser interface
- ▶ ActiveX control for SCADA integration
- ▶ SNMP/OPC gateway

## Legend

The commendations used in this manual have the following meanings:

▶	Listing
□	Work step
■	Subheading

# 1 Device description

The MACH100 devices are managed Workgroup switches with up to 24 Fast Ethernet and 2 Gigabit Ethernet ports. They consist of a basic device and - depending on the device variant - up to 2 pluggable media modules. They allow you to construct switched industrial ETHERNET networks that conform to the IEEE 802.3 and 802.3u standards using copper wires or optical fibers in a bus or ring topology. You can connect terminal devices and other infrastructure components via twisted pair cables, multi-mode fiber optic and single-mode fiber optic. The twisted pair ports support autocrossing, autonegotiation and autopolarity.

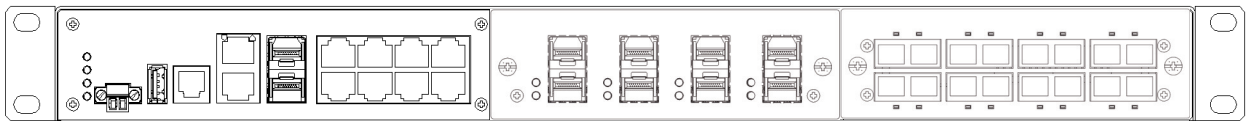

The MACH100 devices provide you with a range of switch variants. You can set up your switch to meet your individual requirements with regard to the transmission media type, the number of 10/100 Mbit/s ports you want (8, 16 or 24), the redundant voltage supply and the software variant.

The devices are modular network components. They are designed for the special requirements of industrial automation. They meet the relevant industry standards, provide very high operational reliability, even under extreme conditions, and also long-term reliability and flexibility. The devices work without a fan. If desired, the voltage supply can be redundant - depending on the device variant. The basic devices are suitable for mounting on the 19" rack and for wall mounting.

The HIPER-Ring redundancy concept enables you to quickly carry out a reconfiguration, and also a simple configuration with only one additional connection. The diagnosis display and the display of the operating parameters and the large label areas provide a quick overview. It can be easily managed via a Web browser, via Telnet, with a management software product (such as HiVision) or locally on the switch (V.24 interface).

The devices provide you with a large range of features:

- ▶ Redundancy functions  
(Rapid Spanning Tree, Redundant Ring Structure, HIPER-Ring, Redundant Coupling, Link Aggregation, Redundant Power Supply)
- ▶ Protection from unauthorized access
- ▶ Synchronized system time in the network
- ▶ Network load control

- ▶ Operation diagnosis
- ▶ Diagnostics (hardware self-testing)
- ▶ Reset
- ▶ Priority
- ▶ VLAN
- ▶ Topology Discovery
- ▶ Web-based Interface
- ▶ Command Line Interface
- ▶ SNMP
- ▶ 802.1x port authentication
- ▶ Real Time Clock

The addition, to the MACH 100 family, of the MICE and RS20/RS30/RS40 open rail family switches, the MACH 3000 and MACH 4000 family of backbone switches, the BAT wireless transmission system, the EAGLE security system, and products for the RSR20/RSR30 and MACH 1000 substation areas, provides continuous communication across all levels of the company.

## **1.1 Description of the device variants**

### **1.1.1 MACH 100 basic device**

A basic device contains all the functions of the industrial Switch and up to 24 Fast Ethernet and 2 Gigabit Ethernet interfaces for connection to the LAN. The MACH 100 devices are managed.

- ▶ The Gigabit ETHERNET combo ports (can be connected optically or with TX) of the basic devices are suitable for the connection of terminal devices or network segments according to the standards IEEE 802.3 100/1000BASE-FX (SFP slot) and IEEE 802.3 1000BASE-TX/ 100BASE-TX / 10BASE-T (RJ45 socket).  
A plugged SFP module switches the TX port off.
- ▶ The Fast ETHERNET ports (10/100 Mbit/s) of the basic devices are suitable for connecting terminal devices or network segments according to the standards IEEE 802.3 100BASE-TX / IEEE 802.3 10 BASE-T. These ports support autonegotiation and autopolarity. The ports are RJ45 sockets. The housings of the RJ45 sockets are electrically connected to the front plate of the device. The pin assignment is identical to MDI-X. When the autonegotiation function is enabled, these ports also support autocrossing.

- ▶ Voltage range: 100 - 240 V AC
- ▶ Temperature range: 0°C to +50 °C
- ▶ Certifications /declarations:  
CE, cUL508 (pending), cUL60950-1 (pending)
- ▶ Software variant: Professional

The devices comply with the specifications of the ISO/IEC standards 8802-3u 100BASE-TX/-1000BASE-T, 8802-3 100BASE-FX and 8802-3 1000BASE-SX/LX.

The MACH 100 basic device contains all the function modules, such as: switch function, management function, redundancy function, voltage connection, management connection, slots for media modules (depending on the device variant).

### ■ **Modular MACH100 basic devices**

The MACH 102-8TP and MACH 102-8TP-R devices from the Industrial ETHERNET MACH100 family are modular switches. The devices consist of a basic switch device and - depending on the device variant - pluggable media modules for additional ports.

Up to two pluggable media modules each provide an additional 8 Fast Ethernet interfaces. They differ as to the media type for connecting segments.

For the sake of simplicity, the basic switch device with various plugged-in media modules will be referred to as MACH 100 in this document.

The basic devices have the following properties:

- ▶ **MACH 102-8TP, MACH 102-8TP-R**
  - ▶ 2 Gigabit ETHERNET combo ports
  - ▶ 8 Fast ETHERNET ports
  - ▶ You can choose the media for an additional 8 or 16 ports via the media modules.
  - ▶ MACH 102-8TP-R: The power supply is connected redundantly.

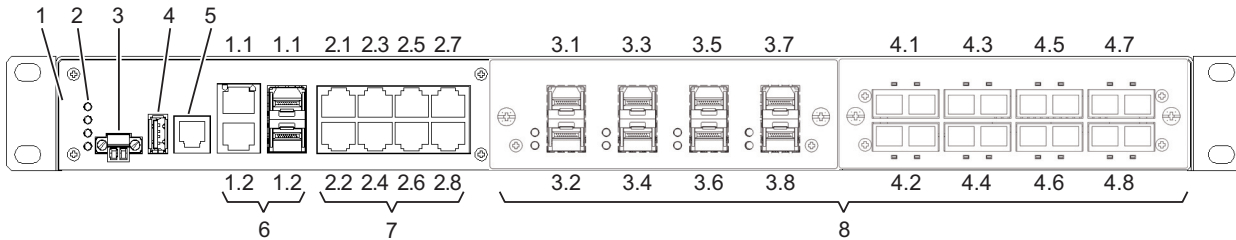

Figure 1: Overview of interfaces and display and control elements in the MACH 102-8TP and MACH 102-8TP-R

- 1 - MACH 100 device
- 2 - LED display elements
- 3 - Signal contact
- 4 - USB interface
- 5 - V.24 access for external management
- 6 - See following table, column 1
- 7 - See following table, column 2
- 8 - See following table, column 3

Gigabit ETHERNET GE ports 1 and 2 (combo ports)	Fast ETHERNET FE ports 1 to 8	Fast ETHERNET FE ports 9 to 24 2 slots for media modules at your option
100/1000 Mbit/s fiber optic, SFP slots Alternatively connectable: 10/100/1000 Mbit/s twisted pair, RJ45 connectors	8 * twisted pair TX, RJ45, 10/100 Mbit/s	8 * twisted pair TX, RJ45, 10/100 Mbit/s or 8 * multimode FX DSC 100 Mbit/s or 8 * singlemode FX DSC 100 Mbit/s or 8 * SFP slot 100 Mbit/s

### ■ Fixed configuration of MACH 100 basic devices

The MACH 102-8TP-F, MACH 102-8TP-FR, MACH 102-24TP-F and MACH 102-24TP-FR devices of the Industrial ETHERNET MACH100 family are switches with a fixed configuration.

The basic devices have the following properties:

- ▶ **MACH 102-8TP-F, MACH 102-8TP-FR**
  - ▶ 2 Gigabit ETHERNET combo ports
  - ▶ 8 Fast ETHERNET ports
  - ▶ MACH 102-8TP-FR: The power supply is connected redundantly.



Figure 2: Overview of interfaces and display and control elements in the MACH 102-8TP-F and MACH 102-8TP-FR

- 1 - MACH 100 device
- 2- LED display elements
- 3 - Signal contact
- 4 - USB interface
- 5 - V.24 access for external management
- 6 - See following table, column 1
- 7 - See following table, column 2

Gigabit ETHERNET - GE ports 1 and 2 (combo ports)	Fast ETHERNET - FE ports 1 to 8
100/1000 Mbit/s fiber optic, SFP slots	8 * twisted pair TX, RJ45, 10/100
Alternatively connectable: 10/100/1000 Mbit/s twisted pair, Mbit/s RJ45 connectors	

- ▶ **MACH 102-24TP-F, MACH 102-24TP-FR**
  - ▶ 2 Gigabit ETHERNET combo ports
  - ▶ 24 Fast ETHERNET ports
  - ▶ MACH 102-24TP-FR: The power supply is connected redundantly.

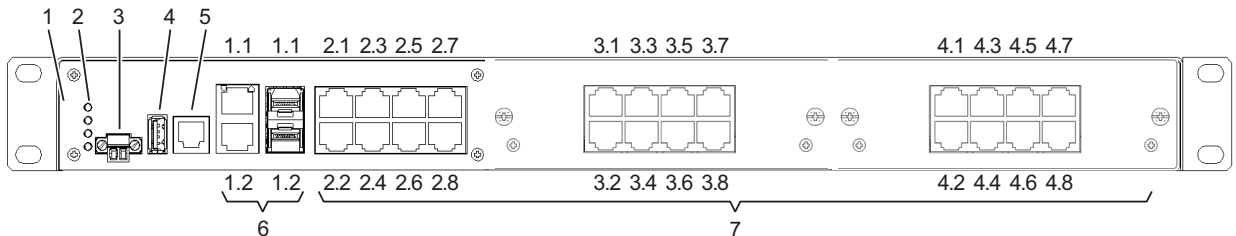

Figure 3: Overview of interfaces and display and control elements in the MACH 102-24TP-F and MACH 102-24TP-FR

- 1 - MACH 100 device
- 2- LED display elements
- 3 - Signal contact
- 4 - USB interface
- 5 - V.24 access for external management
- 6 - See following table, column 1
- 7 - See following table, column 2

Gigabit ETHERNET GE ports 1.1 and 1.2 (combo ports)	Fast ETHERNET FE ports 2.1 to 2.8, 3.1 to 3.8, 4.1 to 4.8
100/1000 Mbit/s fiber optic, SFP slots Alternatively connectable: 10/100/1000 Mbit/s twisted pair, RJ45 connectors	24 * twisted pair TX, RJ45, 10/100 Mbit/s

## 1.1.2 MACH 100 media modules

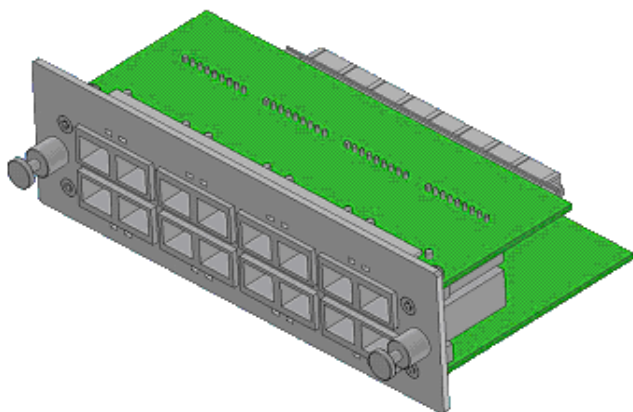

Figure 4: Media module for MACH 100, example: M1-8MM-SC

The MACH 100 media modules form the interface from the device to the LAN.

The modules can be used in

- ▶ MACH 102-8TP basic device
- ▶ MACH 102-8TP-R basic device

The media modules are hot-plug-compatible, which means that you can replace the modules with a module of the same kind during operation.

**Note:** If you are replacing media, e.g. removing a TX media module and plugging in an FX media module in its place, the MACH 100 performs a warm start.

The media modules each have 8 Fast ETHERNET interfaces and differ as to their media type.

The different interfaces of the MACH 100 media modules provide you with the following interface-specific functions:

- ▶ Specific functions of TP/TX interface
  - ▶ Link Control
  - ▶ Auto Polarity Exchange
  - ▶ Autonegotiation
  - ▶ Autocrossing (device may be connected with a crossed-over or an uncrossed cable)



- ▶ Specific functions of fiber optic interface
  - ▶ Link Down monitoring

MACH 100 media modules	TP ports 10/100 Mbit/s	Fiber optic ports Multimode 100 Mbit/s	Fiber optic ports Singlemode 100 Mbit/s	SFP ports Multimode Singlemode Longhaul 100 Mbit/s
M1-8TP-RJ45	8, RJ45	–	–	–
M1-8MM-SC	–	8, SC	–	–
M1-8SM-SC	–	–	8, SC	–
M1-8SFP	–	–	–	8, SFP

Table 1: Media connections per MACH 100 media module (number and type)

### ■ Media module M1-8TP-RJ45

The M1-8TP-RJ45 media module has 8 x 10/100 Mbit ports for connecting terminal devices or network segments according to the standards IEEE 802.3 100BASE-TX / IEEE 802.3 10 BASE-T.

These ports support autonegotiation and autopolarity. The ports are RJ45 sockets. The housings of the RJ45 sockets are electrically connected to the front plate of the device. The pin assignment is identical to MDI-X. When the autonegotiation function is enabled, these ports also support autocrossing.

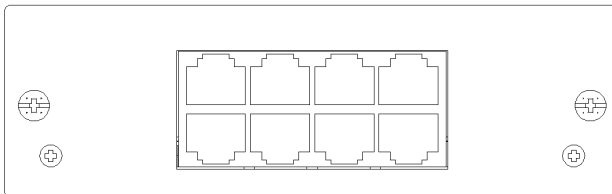

Figure 5: Media module M1-8TP-RJ45

### ■ Media module M1-8MM-SC

The M1-8MM-SC media module has 8 FX ports for connecting terminal devices or network segments in compliance with the IEEE 802.3u 100BASE-FX Multimode standard. The optical ports are configured in 100 Mbit/s Fullduplex (FDX) and support FEFI. They have a SC design.

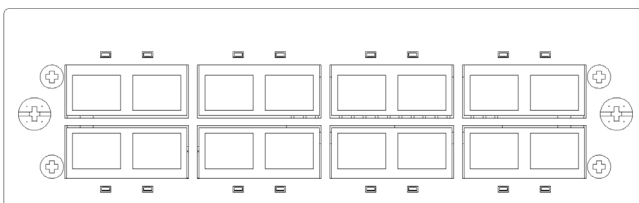

Figure 6: Media module M1-8MM-SC

## ■ Media module M1-8SM-SC

The M1-8SM-SC media module has 8 FX ports for connecting terminal devices or network segments in compliance with the IEEE 802.3u 100BASE-FX Singlemode standard. The optical ports are configured in 100 Mbit/s Fullduplex (FDX) and support FEFI. They have a SC design.

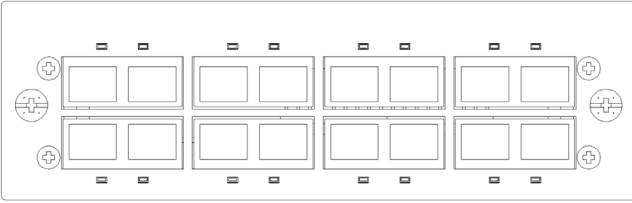

Figure 7: Media module M1-8SM-SC

## ■ Media module M1-8SFP

The M1-8MM-SC media module has 8 FX ports for connecting terminal devices or network segments in compliance with the IEEE 802.3u 100BASE-FX Multimode/Singlemode/Longhaul standard. The optical ports are configured in 100 Mbit/s Fullduplex (FDX) and support FEFI. They are designed as SFP slots for the Hirschmann SFP module types M-FAST SFP-... (see page 38 „Accessories“).

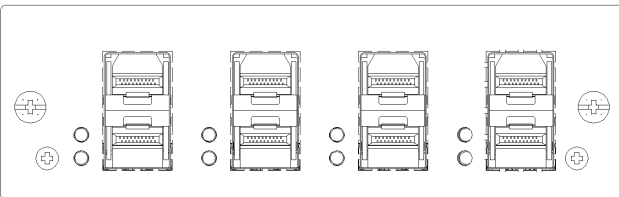

Figure 8: Media module M1-8SFP

### 1.1.3 SFP modules

SFP modules are optical transceivers (Fast ETHERNET and Gigabit ETHERNET SFP modules, see page 38 „Accessories“). SFP stands for Small Form-factor Pluggable and is also frequently referred to as mini-GBIC (Giga-Bit Interface Converter).

The SFP modules are plugged into the SFP slots of the MACH 100 basic device in order to obtain a fiber optic port. The MACH 100 has two TP interfaces and two slots for inserting SFP modules (100/1000 Mbit/s).

By inserting the SFP module you deactivate the corresponding TP interface.

Module type	Transmission	Range	Connection
<b>Fast ETHERNET SFP modules:</b>			LC
M-FAST SFP-MM / LC	1310 nm Multimode	4 km	LC
M-FAST SFP-SM / LC	1310 nm Singlemode	25 km	LC
M-FAST SFP-SM+ / LC	1310 nm Singlemode	25-65 km	LC
M-FAST SFP-LH / LC	1550 nm Longhaul	40-104 km	LC
<b>Gigabit ETHERNET SFP modules:</b>			LC
M-SFP-SX/LC	850 nm Multimode	0.55 km	LC
M-SFP-LX/LC	1330 nm Multimode	0.55 km	LC
	1330 nm Singlemode	20 km	LC
M-SFP-LH/LC	Longhaul	8-72 km	LC
M-SFP-LH+/LC	Longhaul +	60-120 km	LC

*Table 2: SFP modules*

**Note:** Only use Hirschmann SFP modules ([see page 38 „Accessories“](#)).

## 2 Assembly and start-up

The devices have been developed for practical application in a harsh industrial environment. The installation process is correspondingly simple.

On delivery, the device is ready for operation.

The following procedure has been proven to be successful for the assembly of the device:

- ▶ Unpacking and checking
- ▶ Installing the media modules
- ▶ Installing the SFP modules
- ▶ Signal contact
- ▶ Installing the device and grounding
- ▶ Supply voltage
- ▶ Startup
- ▶ Installing the data lines

### 2.1 Installing the device

#### 2.1.1 Unpacking and checking

- Check whether the contents of the package are complete (see page 38 „Scope of delivery“).
- Check the individual parts for transport damage.

#### 2.1.2 Installing the media modules

On delivery, the device is ready for operation.

The modules can be used in

- ▶ MACH 102-8TP basic device
- ▶ MACH 102-8TP-R basic device

- See the ESD guidelines on page 8 and the safety instructions on page 7ff.

The media modules are hot-plug-compatible, which means that you can replace the modules with a module of the same kind during operation.

**Note:** If you are replacing media, e.g. removing a TX media module and plugging in an FX media module in its place, the MACH 100 performs a warm start.

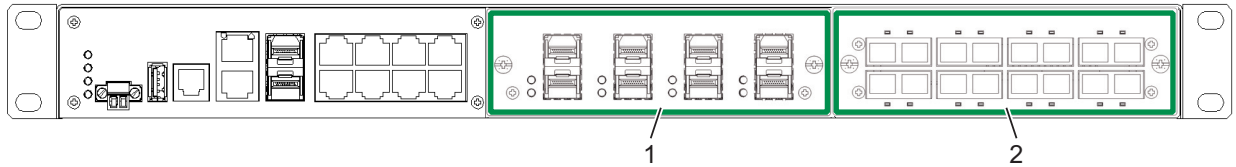
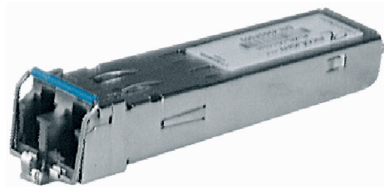

Figure 9: MACH 100 device equipped with media modules  
 1 - Media module 1  
 2 - Media module 2

- To attach a media module, first remove the 2 screws on the protective cover of the media module slot and remove the protective cover.
- Plug the media module into the desired slot.
- Fasten the 2 screws at the corners of the media module.
- Fit the media modules in sequence from left to right.

### 2.1.3 Installing the SFP modules



Fast ETHERNET  
 fiberoptic SFP module

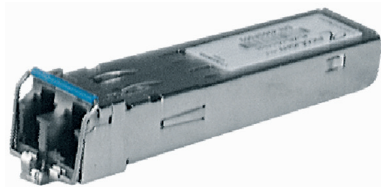

Gigabit ETHERNET  
 fiberoptic SFP module

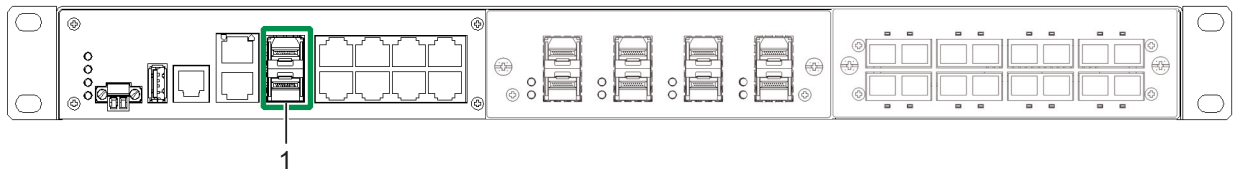

Figure 10: MACH 100 device, front view  
 1 - Two SFP slots

- To attach an SFP module, first remove the protective cap over the socket.
- Push the SFP module with the lock closed into the socket until it latches audibly in place.

**Note:** Only use Hirschmann SFP modules ([see page 38 „Accessories“](#)).

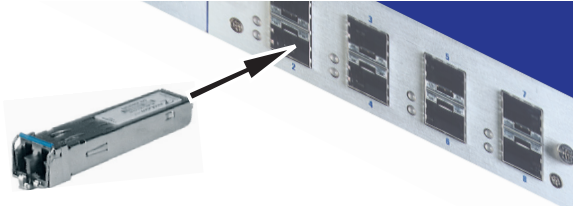

Figure 11: Installing an SFP module

## 2.1.4 Signal contact „FAULT“

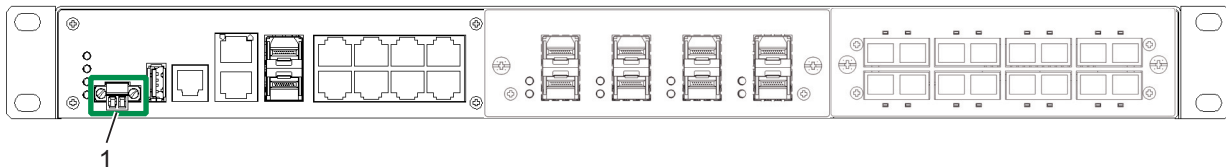

Figure 12: MACH 100 device, front view  
1 - Signal contact

The signal contacts are connected via a 2-pin terminal block with screw locking.

- ▶ The signal contact (“FAULT”, for pin assignment see [fig. 13](#)) is used for the remote monitoring of the device to enable remote diagnostics. You can specify the type of function monitoring in the Management.
- ▶ You can also use the Management to set the signal contact manually and thus control external devices.

A break in contact is used to report the following conditions via the potential-free signal contact (relay contact, closed circuit):

- ▶ The failure of at least one of the two voltage supplies (voltage supply 1 or 2 is below the threshold value).
- ▶ A continuous malfunction in the device (internal supply voltage).
- ▶ The defective link status of at least one port. The report of the link status can be masked by the Management for each port. In the default state, link status monitoring is deactivated.
- ▶ The temperature threshold has been exceeded or has not been reached.
- ▶ The removal of the ACA.

The following condition is also reported in RM mode:

- ▶ Ring redundancy guaranteed. By default, there is no ring redundancy monitoring

### ■ Connecting the terminal block

- Pull the terminal block off the device and connect the signal lines.

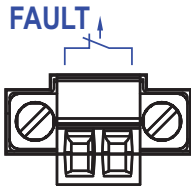

Figure 13: 2-pin terminal block

**Note:** Please note the electrical ratings for the signal contact (see on page 35 „General technical data“).

**Note:** Relevant for North America:

The tightening torque of the terminal block screws is 0,34 Nm (3 lb in).

- Mount the terminal block for the signal contact on the front of the device using the screw locking. Check whether the terminal block is mounted correctly and screwed on.

### 2.1.5 Dimension drawings

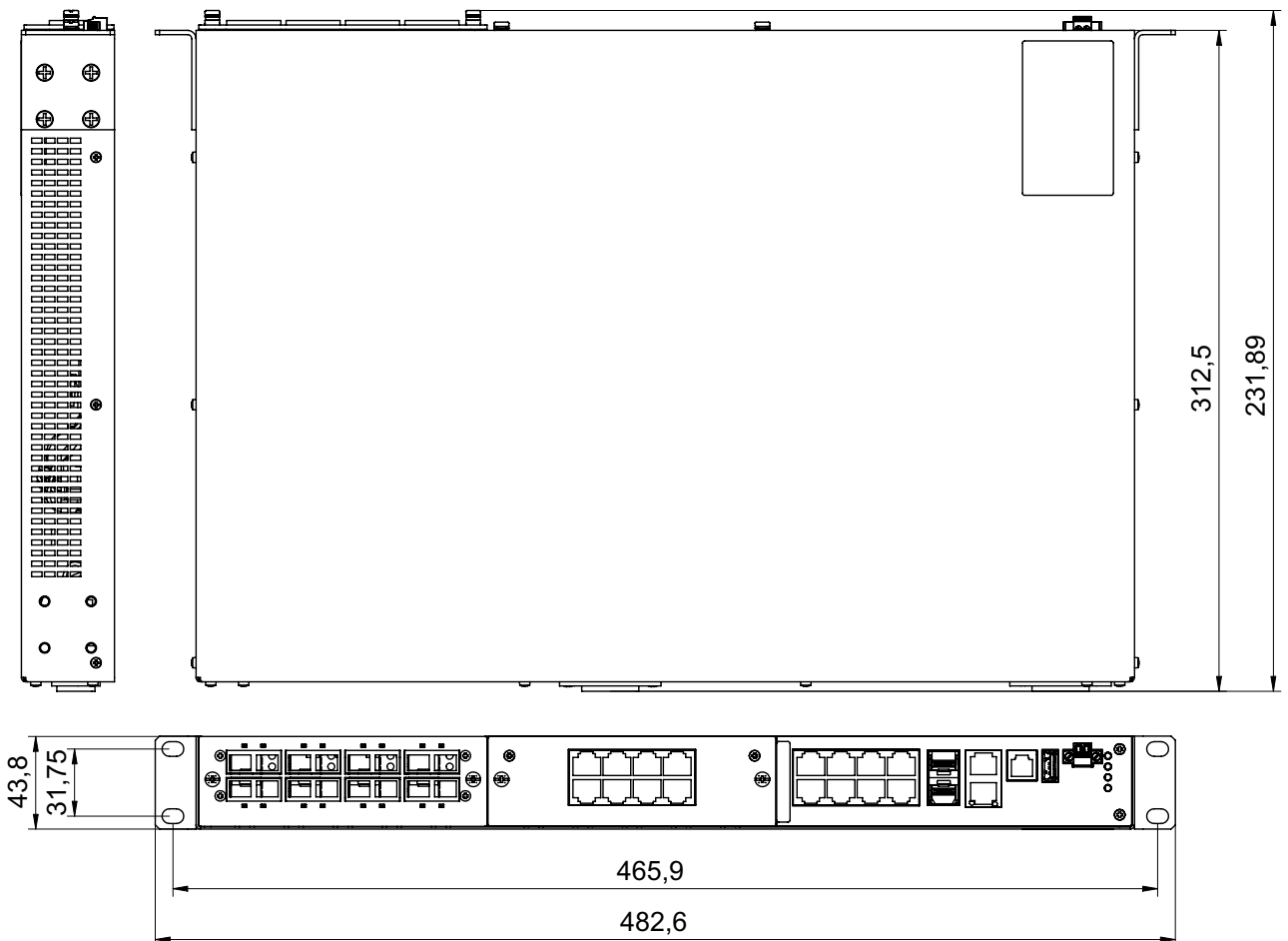

## 2.1.6 Installing the device and grounding

The device can be mounted on a flat surface, in a 19" standard switch cabinet, or on the wall.

Consider the following criteria when selecting the location for mounting your device:

- The installation location should be close to a power outlet.
- The climatic threshold values listed in the technical data must be adhered to.
- The ventilation slits must not be covered so as to ensure free air circulation.
- The clearance to the ventilation slits of the housing must be at least 10 cm (3.94 in).
- The installation location should be freely accessible for the installation and for maintenance and repairs.
- The LED display elements should be clearly and easily visible.
- Make sure that the TP cable is far enough away from power cables and other sources of possible electrical interference.
- Make sure that the device is connected to a separate power source with a ground connection and a main voltage in line with the technical data, and that the device is supplied with power via a separate isolator or power switch. It is recommended to use overvoltage protection for all devices.

**Note:** The shielding ground of the connectable industrial twisted pair lines is connected to the front panel as a conductor.

### ■ Mounting the MACH 100 as a table unit

- Install the device in line with the criteria listed in [„Installing the device and grounding“](#).

### ■ Mounting the MACH 100 in the switch cabinet

The devices are designed to be mounted in a 19" rack.

- Make sure there is sufficient ventilation. If necessary, provide a fan for the 19" rack. This will prevent the basic devices from overheating.
- Measure the depth of the 19" rack so as to allow the main cable, and any power supply cables, to be fitted from the back, and the data cables to be fitted from the front.

If you are operating the device in a 19" switch cabinet, you must install sliding/mounting rails (not included in the delivery) to hold the weight of the device.





### Warning

If the device is installed in a 19" switch cabinet without sliding/mounting rails, increased vibration can cause damage to the device and/or its modules.

For more information on sliding/mounting rails and how to install them, please contact your switch cabinet manufacturer.

- Install the sliding/mounting rails in the 19" switch cabinet as instructed by the manufacturer, and make sure the device is resting on both rails.

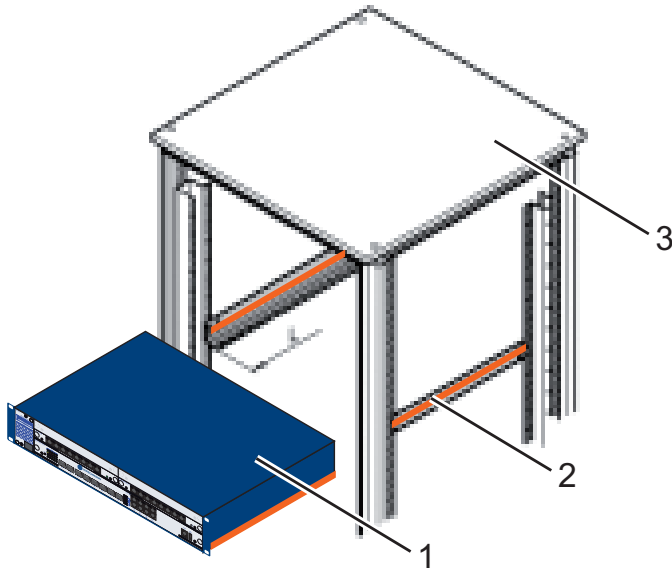

Figure 14: Installation in the switch cabinet with sliding/mounting rails

- 1 - MACH 100 device
- 2 - Chassis runner
- 3 - 19" rack

On delivery, two brackets are attached to the sides of the device (see figure below).

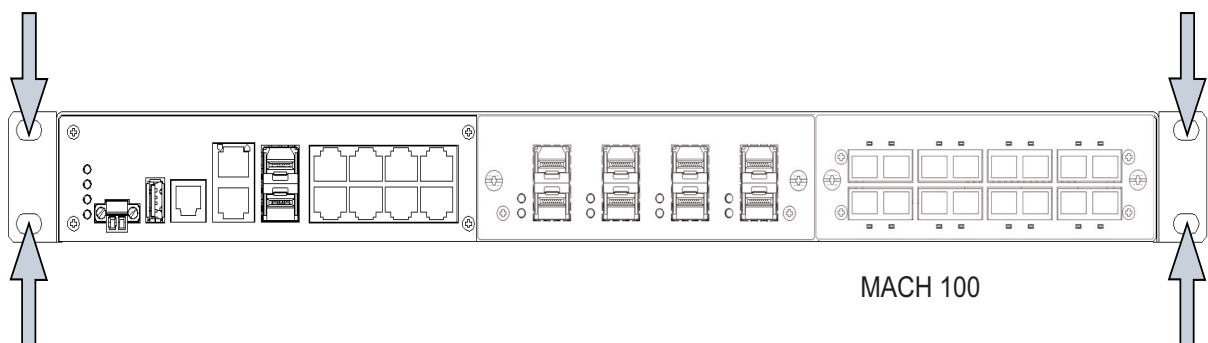

Figure 15: Mounting the MACH 100 in the 19" cabinet

- Fasten the device by screwing the brackets to the switch cabinet.



### Warning

When installing the device, make sure the ventilation slots remain unobstructed, as otherwise the device can overheat and be damaged.

**Note:** When operating the device in environments with strong vibrations, the device can be fastened with two additional brackets at the back of the switch cabinet (see on page 38 „Accessories“), not included in the delivery.

### ■ Mounting the MACH 100 on the wall

- Use the pre-mounted brackets included in the delivery as shown in the following figure (see fig. 16).
- Attach two additional brackets to the device (see on (see on page 38 „Accessories“), not included in the delivery) as shown in the following figure (see fig. 16).
- Fasten the device by screwing the brackets to the wall.



### Warning

When installing the device, make sure the ventilation slots remain unobstructed, as otherwise the device can overheat and be damaged.

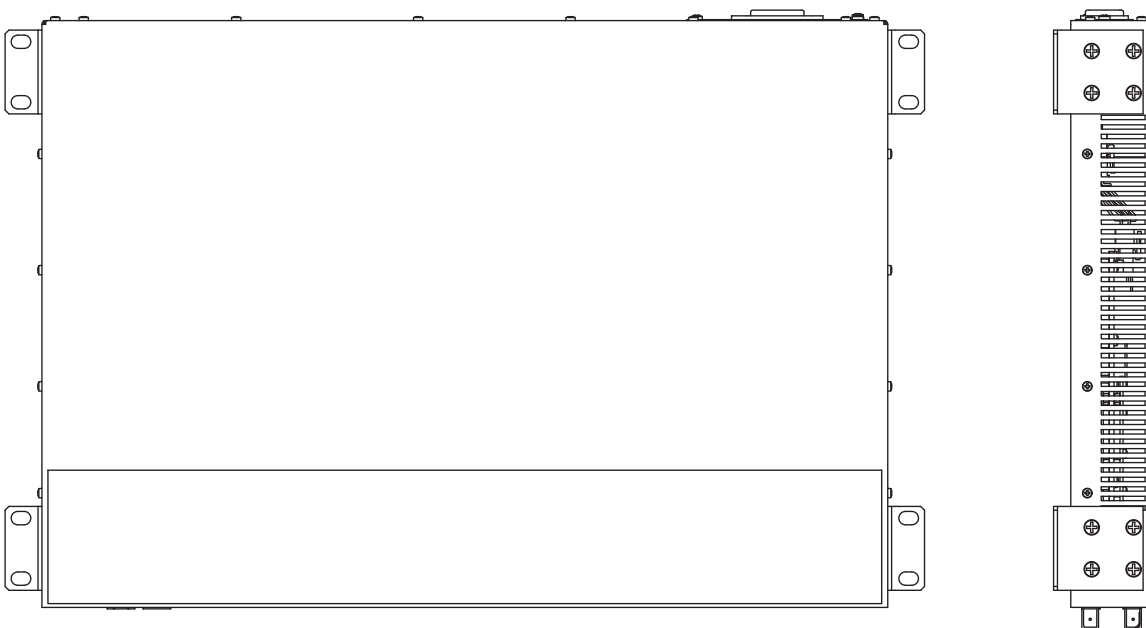

Figure 16: Vertical mounting on the wall

**Note:** The shielding ground of the connectable industrial twisted pair lines is connected to the front panel as a conductor.

## ■ Grounding

The device is grounded via the voltage supply socket ((see fig. 17) and (see fig. 18)).

### 2.1.7 Supply voltage

The input voltage range of the MACH 100 basic devices is designed as 100 - 240 VAC.

The power supply for the MACH 102-8TP-R, MACH 102-8TP-FR and MACH 102-24TP-FR devices is designed as redundant.



**Note:** Note the safety instructions in the chapter from page (see page 7 „General safety instructions“) and only connect a supply voltage that corresponds to the type plate of your device.

## ■ MACH 102-8TP, MACH 102-8TP-F and MACH 102-24TP-F

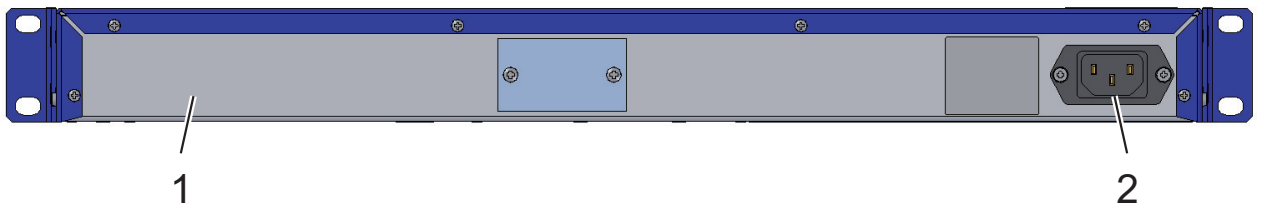

Figure 17: Connections for the MACH 102-8TP, MACH 102-8TP-F and MACH 102-24TP-F on the back of the device

- 1 - MACH 102-8TP, MACH 102-8TP-F or MACH 102-24TP-F device
- 2 - Power supply 100 - 240 V AC

## ■ MACH 102-8TP-R, MACH 102-8TP-FR, MACH 102-24TP-FR

The supply voltage can be connected redundantly. Both inputs are uncoupled. There is no distributed load. With redundant supply, the standard voltage supply alone supplies the device. The redundant voltage supply automatically becomes active if the standard voltage supply fails. In the normal case, the redundant voltage supply works in stand-by mode. The supply voltage is electrically isolated from the housing.

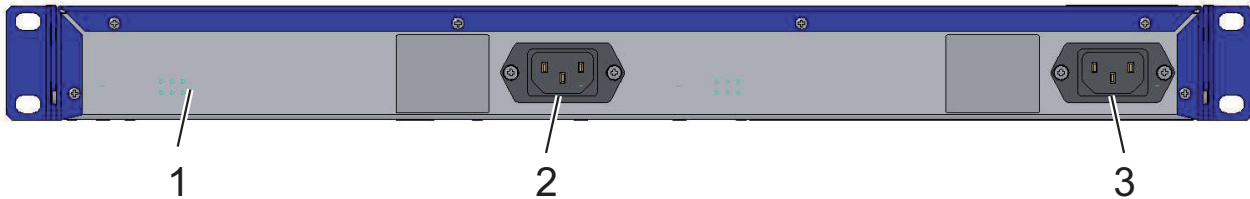

Figure 18: Connections for the MACH 102-8TP-R, MACH 102-8TP-FR and MACH 102-24TP-FR on the back of the device  
1 - MACH 102-8TP-R, MACH 102-8TP-FR or MACH 102-24TP-FR device  
2 - Redundant power supply 100 - 240 V AC  
3 - Standard power supply 100 - 240 V AC

**Note:** With non-redundant supply of the main voltage, the device reports a loss of power. You can avert this message by applying the supply voltage via both inputs, or by changing the configuration in the Management.

### 2.1.8 Startup procedure

By connecting the voltage supply via the voltage supply socket(s), you start the operation of the device.

### 2.1.9 Installing the data lines

#### ■ 10/100 Mbit/s twisted pair connection

10/100 Mbit/s ports (RJ45 or M12 sockets) enable the connection of terminal devices or independent network segments according to the IEEE 802.3 100BASE-TX / 10BASE-T standards.

These ports support:

- ▶ Autonegotiation
- ▶ Autopolarity
- ▶ Autocrossing (if autonegotiation is activated)
- ▶ 100 Mbit/s half duplex, 100 Mbit/s full duplex,
- ▶ 10 Mbit/s half duplex, 10 Mbit/s full duplex.

Default settings: autonegotiation activated.

The socket housings are electrically connected to the front panel.

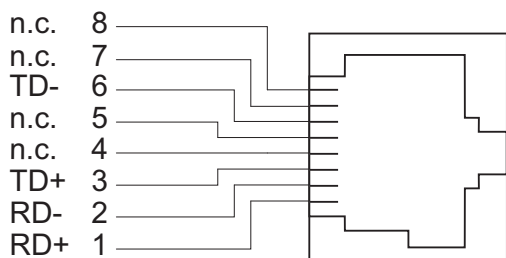

Figure 19: Pin assignment of a TP/TX interface in MDI-X mode, RJ45 socket

### ■ 10/100/1000 Mbit/s twisted pair connection

1000 Mbit/s twisted pair ports (RJ45 sockets) facilitate the connection of terminal devices or independent network segments according to the IEEE 802.3-2000 (ISO/IEC 8802-3:2000) 1000BASE-TX standard.

These ports support:

- ▶ Autonegotiation
- ▶ Autopolarity
- ▶ Autocrossing (if autonegotiation is activated)
- ▶ 1000 Mbit/s full duplex
- ▶ 100 Mbit/s half duplex, 100 Mbit/s full duplex,
- ▶ 10 Mbit/s half duplex, 10 Mbit/s full duplex.

Default settings: autonegotiation.

The socket housing is electrically connected to the front panel.

The pin assignment corresponds to MDI-X.

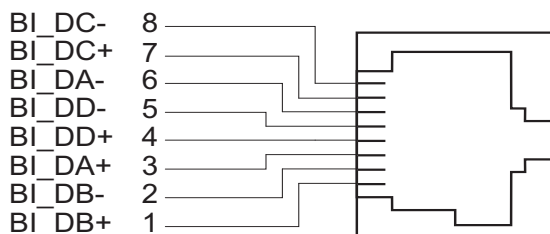

Figure 20: Pin assignment of the 1000 Mbit/s twisted pair interface

**Note:** In general, you should adhere to the following recommendations for data cable connections using copper in environments with high electrical interference levels:

- ▶ Keep the length of the data cables as short as possible - ideally max. 3m long. You should not use any copper data cables for the data transmission between buildings.

- ▶ Power supply and data cables should not run parallel over longer distances, and ideally they should be installed in separate cable channels. If the inductive coupling has to be reduced, the power supply and data cables should cross at a 90° angle.
- ▶ You may also choose to use shielded cables. Ground the cable shielding at one point in order to avoid causing a ground loop.

### ■ **100 Mbit/s fiber optic connection**

100 MBit/s fiber optic ports (SC, SFP slot) enable the connection of terminal devices or independent network segments in compliance with the IEEE 802.3 100BASE-FX standard. These ports support:

- ▶ Full or half duplex mode

Default settings: full duplex

**Note:** Make sure that the LH ports are only connected with LH ports, SM ports are only connected with SM ports, and MM ports only with MM ports.

### ■ **1 Gbit/s fiber optic connection**

1 GBit/s fiber optic ports (SFP slot) enable the connection of terminal devices or independent network segments in compliance with the IEEE 802.3-2000 (ISO/IEC 8802-3:2000) 1000BASE-SX or 1000BASE-LX standards. These ports support:

- ▶ Autonegotiation
- ▶ Full duplex mode

Default settings: autonegotiation

**Note:** Make sure that the LH ports are only connected with LH ports, SX ports are only connected with SX ports, and LX ports only with LX ports.

## **2.2 Display elements**

After the operating voltage is set up, the software starts and initializes itself. Afterwards, the device performs a self-test. During this process, various LEDs light up. The process takes around 70 seconds.

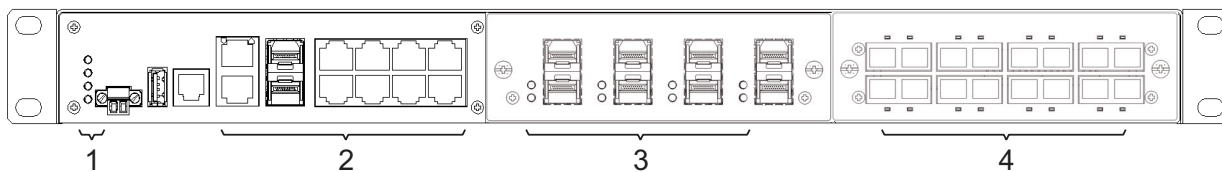

Figure 21: MACH 100 display elements

- 1 - Displays for device state
- 2 - Displays for port state
- 3 - Displays for port state, media module 1
- 4 - Displays for port state, media module 2

## ■ Device state

These LEDs provide information about conditions which affect the operation of the whole device.

<b>P - Power (green/yellow LED)</b>	
Glowing green	MACH 102-8TP, MACH 102-8TP-F, MACH 102-24TP-F: Supply voltage is on. MACH 102-8TP-R, MACH 102-8TP-FR, MACH 102-24TP-FR: Supply voltages 1 and 2 are on.
Glowing yellow	MACH 102-8TP-R, MACH 102-8TP-FR, MACH 102-24TP-FR: Supply voltage 1 or 2 is on.
Not glowing	MACH 102-8TP, MACH 102-8TP-F, MACH 102-24TP-F: Supply voltage is below minimum value. MACH 102-8TP-R, MACH 102-8TP-FR, MACH 102-24TP-FR: Supply voltages 1 and 2 are below minimum value.
<b>RM - Ring Manager (green/yellow LED)</b>	
Glowing green	RM function active, redundant port disabled
Glowing yellow	RM function active, redundant port enabled
Not glowing	RM function not active
Flashing green	Incorrect configuration of the HIPER-Ring (e.g. the ring is not connected to the ring port).
<b>Stand-by - Stand-by mode (green LED)</b>	
Glowing green	Stand-by mode enabled.
Not glowing	No stand-by mode.
<b>FAULT - signal contact (red LED)</b>	
Glowing red	Signal contact 1 is open, i.e. it is reporting an error.
Not glowing	Signal contact 1 is closed, i.e. it is not reporting an error.
<b>RM and Stand-by - display saving processes of the AutoConfiguration Adapter (ACA)</b>	
Flashing alternately	Error during saving process.
LEDs flash synchronously, two times a second	Loading configuration from the ACA.
LEDs flash synchronously, once a second	Saving the configuration in the ACA.

If the manual adjustment is active on the “FAULT” signal contact, then the detected error display is independent of the setting of the signal contact.

## ■ **Port state**

These LEDs display port-related information.

<b>LS - data, link status (one green/yellow LED or one green and one yellow LED)</b>	
Not glowing	No valid connection.
Glowing green	Valid connection.
Flashing green (1 time a period)	Port is switched to stand-by.
Flashing green (3 times a period)	Port is switched off.
Flashing yellow	Data reception.

## **2.3 Making basic settings**

The IP parameters must be entered when the device is installed for the first time. The device provides 6 options for configuring IP addresses:

- ▶ Entry via V.24 connection
- ▶ Entry using the HiDiscovery protocol
- ▶ Configuration via BOOTP
- ▶ Configuration via DHCP
- ▶ Configuration via DHCP Option 82
- ▶ Auto Configuration Adapter

Further information on the basic settings of the device can be found in the "Basic Configuration" user manual on the CD ROM.

## ■ **Default settings**

- ▶ IP address: The device looks for the IP address using DHCP
- ▶ Management password:  
user, password: public (read only)  
admin, password: private (read and write)
- ▶ V.24 data rate: 9,600 Baud
- ▶ Ring redundancy: off
- ▶ Ethernet ports: link status is not evaluated (signal contact)
- ▶ Optical 100 Mbit/s ports: 100 Mbit/s full duplex  
All other ports: autonegotiation
- ▶ Redundancy manager switched off  
(DIP switch RM and Stand-by: ON)
- ▶ Stand-by coupling switched off  
(DIP switch RM and Stand-by: ON)  
Port 3 = control port, port 4 = coupling port for redundant ring coupling
- ▶ Rapid Spanning Tree: on



## ■ USB interface

The USB socket has an interface for the local connection of an AutoConfiguration Adapter (part number ACA 21-USB see on [page 38](#) „Accessories“). It is used for saving/loading the configuration and for loading the software.

Figure	Pin	Function
	1	VCC (VBus)
	2	- Data
	3	+ Data
	4	Ground (GND)

Table 3: Pin assignment of the USB interface

## ■ V.24 interface (external management)

A serial interface is provided on the RJ11 socket (V.24 interface) for the local connection of an external management station (VT100 terminal or PC with appropriate terminal emulation) or an AutoConfiguration Adapter ACA 11. This enables a connection to the Command Line Interface (CLI) and the system monitor to be made.

VT 100 terminal settings	
Speed	9,600 Baud
Data	8 bit
Stopbit	1 bit
Handshake	off
Parity	none

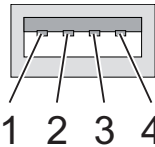
The socket housing is electrically connected to the front panel of the device. The V24 interface is not electrically isolated from the supply voltage.

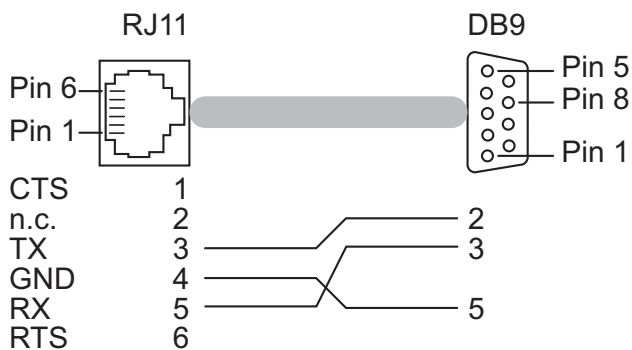

Figure 22: Pin assignment of the V24 interface

**Note:** You will find the order number for the terminal cable, which is ordered separately, in the Technical Data chapter (see on page 35 „Technical data“).

## 2.4 Disassembly

### ■ Disassembling the device

- To detach the device from the switch cabinet or the wall, remove the screws from the brackets on the device.

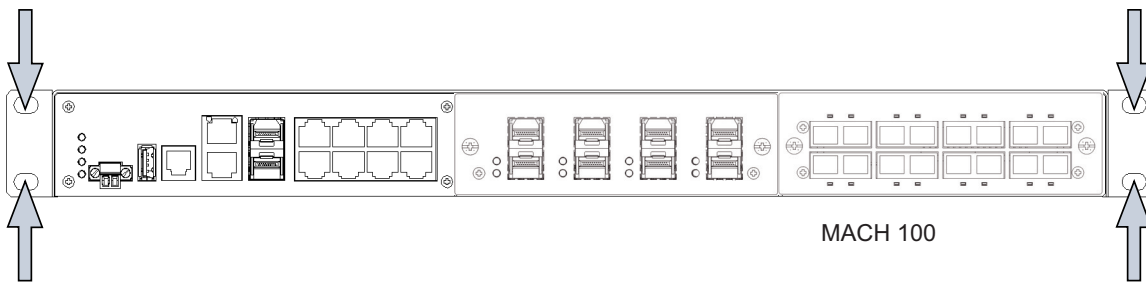

Figure 23: Disassembly

### ■ Disassembling the SFP modules

- Pull the SFP module by the opened lock out of the socket.
- Close the socket with the protective cap.

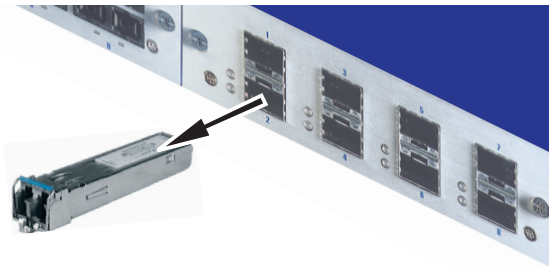

Figure 24: Disassembling an SFP module

## 3 Technical data

### ■ General technical data

Dimensions W x H x D	MACH 102-...	448 mm x 310 mm x 44 mm (without brackets)
Weight of devices	MACH102-	3.60 kg
	8TPMACH102-8TP-	3.85 kg
	RMACH102-8TP-	3.60 kg
	FMACH102-8TP-	3.85 kg
	FRMACH102-24TP- FMACH102-24TP-FR	3.85 kg 4.10 kg
Weight of media modules	M1-8TP-RJ45M1-	0.21 kg
	8MM-SCM1-8SM-	0.21 kg
	SCM1-8SFP	0.18 kg
		0.13 kg
Power supply	Rated voltage	100 - 240 VAC
	Rated frequency	47 - 63 Hz
	Rated power range	0.4 - 0.2 A
Overload current protection at input		Non-replaceable fuse
Activation current		typ. <40 A at 265 V AC and cold start
"FAULT" signal contact		max. 60 V DC or max. 30 V AC, SELV
Environment	Storage temperature (ambient air tempera- ture)	-20 °C to +85 °C
	Humidity	10% to 95% (non-condensing)
	Air pressure (in opera- tion)	Up to 2000 m (795 hPa), higher altitudes on request
Operating temper- ature		0 °C to +50 °C
Pollution degree		2
Protection classes	Laser protection	Class 1 according to EN 60825-1 (2001)
	Protection class	IP 20

### ■ EMC and immunity

EMC interference immunity		
EN 61000-4-2	Electrostatic discharge	
	Contact discharge	4 kV
	Air discharge	8 kV
EN 61000-4-3	Electromagnetic field 80 - 2,700 MHz	10 V/m
EN 61000-4-4	Fast transients (burst)	
	- Power line - Data line	2 kV 4 kV

EMC interference immunity		
EN 61000-4-5	Voltage surges - Power line, line/line: - Power line, line/earth - Data line	1 kV 2 kV 4 kV
EN 61000-4-6	Line-conducted interference voltages 150 kHz - 80 MHz	10 V
EMC emitted interference		
EN 55022	Class A	Yes
FCC 47 CFR Part 15	Class A	Yes

## ■ Network range

TP port	
Length of a twisted pair segment	max. 100 m / 300 ft (cat5e cable with 1000BASE-T)

Table 4: TP port 10BASE-T / 100BASE-TX / 1000BASE-T

Product code M-FAST-SFP-...	Wave-length	Fiber	System at-tenuation	Example for fiber optic line length	Fiber data
-MM/LC...	MM 1310 nm	50/125 µm	0-11 dB	0-5 km	1.0 dB/km, 800 MHz*km
-MM/LC...	MM 1310 nm	62.5/125 µm	0-8 dB	0-4 km	1.0 dB/km, 500 MHz*km
-SM/LC...	SM 1310 nm	9/125 µm	0-13 dB	0-25 km	0.4 dB/km; 3.5 ps/(nm*km)
-SM+/LC...	SM 1310 nm	9/125 µm	10-29 dB	25-65 km	0.4 dB/km; 3.5 ps/(nm*km)
-LH/LC	SM 1550 nm	9/125 µm	10-29 dB	40-104 km	0.25 dB/km; 19 ps/(nm*km)

Table 5: Fiber port 100BASE-FX (SFP fiber optic Fast ETHERNET Transceiver)

Product code M-SFP-...	Wave-length	Fiber	System at-tenuation	Example for fiber optic line length	Fiber data
-SX/LC...	MM 850 nm	50/125 µm	0-7.5 dB	0-550 m	3.0 dB/km, 400 MHz*km
-LX/LC...	MM 1310 nm <sup>a</sup>	50/125 µm	0-11 dB	0-550 m	1.0 dB/km, 800 MHz*km
-SX/LC...	MM 850 nm	62.5/125 µm	0-7.5 dB	0-275 m	3.2 dB/km, 200 MHz*km
-LX/LC...	MM 1310 nm <sup>a</sup>	62.5/125 µm	0-11 dB	0-550 m	1.0 dB/km, 500 MHz*km
-LX/LC...	SM 1310 nm	9/125 µm	0-11 dB	0-20 km	0.4 dB/km; 3.5 ps/(nm*km)
-LH/LC...	LH 1550 nm	9/125 µm	6-22 dB	24-72 km	0.25 dB/km; 19 ps/(nm*km)
-LH+/LC	LH 1550 nm	9/125 µm	15-32 dB	60-120 km	0.25 dB/km; 19 ps/(nm*km)

Table 6: Fiber port 1000BASE-FX (SFP fiber optic Gigabit ETHERNET Transceiver)

- a. With F/O adapter compliant with IEEE 802.3-2002 clause 38 (single-mode fiber offset-launch mode conditioning patch cord)

MM = Multimode, SM = Singlemode, LH = Singlemode Longhaul

## ■ Power consumption/power output, temperature range and order numbers

MACH 100 Family	Description
<b>Basic devices</b>	
MACH102-8TP	Basic device MACH 100 family with 2 x Gigabit ETHERNET combo port, 8 x Fast ETHERNET TX, 2 sockets for media modules for up to 16 additional ports
MACH102-8TP-R	Basic device MACH 100 family with 2 x Gigabit ETHERNET combo port, 8 x Fast ETHERNET TX, 2 sockets for media modules for up to 16 additional ports and redundant power supply
MACH102-8TP-F	Basic device MACH 100 family with 2 x Gigabit ETHERNET combo port, 8 x Fast ETHERNET TX
MACH102-8TP-FR	Basic device MACH 100 family with 2 x Gigabit ETHERNET combo port, 8 x Fast ETHERNET TX and redundant power supply
MACH102-24TP-F	Basic device MACH 100 family with 2 x Gigabit ETHERNET combo port, 24 x Fast ETHERNET TX
MACH102-24TP-FR	Basic device MACH 100 family with 2 x Gigabit ETHERNET combo port, 24 x Fast ETHERNET TX and redundant power supply
<b>Media modules</b>	
M1-8TP-RJ45	8 x Fast ETHERNET TX RJ45
M1-8MM-SC	8 x Fast ETHERNET Multimode, SC connector
M1-8SM-SC	8 x Fast ETHERNET Singlemode, SC connector
M1-8SFP	8 x Fast ETHERNET, SFP slot

Table 7: Power, temperature and order numbers

MACH 100 Family Device/module	Power consumption	Power output	Operating temperature ambient air	Order number
<b>Basic devices</b>				
MACH102-8TP	12 W	41 Btu (IT)/h	0 °C to +50 °C	943 969-001
MACH102-8TP-R	13 W	44 Btu (IT)/h	0 °C to +50 °C	943 969-101
MACH102-8TP-F	12 W	41 Btu (IT)/h	0 °C to +50 °C	943 969-201
MACH102-8TP-FR	13 W	44 Btu (IT)/h	0 °C to +50 °C	943 969-301
MACH102-24TP-F	16 W	55 Btu (IT)/h	0 °C to +50 °C	943 969-401
MACH102-24TP-FR	17 W	58 Btu (IT)/h	0 °C to +50 °C	943 969-501
<b>Media modules</b>				
M1-8TP-RJ45	2 W	7 Btu (IT)/h	0 °C to +50 °C	943 970-001
M1-8MM-SC	10 W	34 Btu (IT)/h	0 °C to +50 °C	943 970-101
M1-8SM-SC	10 W	34 Btu (IT)/h	0 °C to +50 °C	943 970-201
M1-8SFP (incl SFP modules)	11 W	37 Btu (IT)/h	0 °C to +50 °C	943 970-301

## ■ Interfaces

### Basic devices

MACH102-8TP, MACH102-8TP-R, MACH102-8TP-F, MACH102-8TP-FR, MACH102-24TP-F or MACH102-24TP-FR	V.24 port: external management 1 terminal block, 2-pin: each 1 x signal contact, max. 1 A, 24 V USB: ACA 21-USB
MACH102-8TP or MACH102-8TP-R	- 2 combo ports (alternatively 100/1000 Mbit/s optical SFP slot or 1000/100/10 Mbit/s RJ45 socket) - 8 x 10/100 Mbit/s twisted pair, RJ45 socket - 2 slots for media modules (M1-8TP-RJ45, M1-8MM-SC, M1-8SM-SC or M1-8SFP)
MACH102-8TP-F or MACH102-8TP-FR	- 2 combo ports (alternatively 100/1000 Mbit/s optical SFP slot or 1000/100/10 Mbit/s RJ45 socket) - 8 x 10/100 Mbit/s twisted pair, RJ45 socket
MACH102-24TP-F or MACH102-24TP-FR	- 2 combo ports (alternatively 100/1000 Mbit/s optical SFP slot or 1000/100/10 Mbit/s RJ45 socket) - 24 x 10/100 Mbit/s twisted pair, RJ45 socket

### Media modules

M1-8TP-RJ45	8 x 100 Mbit/s twisted pair, RJ45 socket
M1-8MM-SC	8 x 100 Mbit/s Multimode, duplex SC plug
M1-8SM-SC	8 x 100 Mbit/s Singlemode, duplex SC plug
M1-8SFP	8 x 100 Mbit/s, SFP slot

## ■ Scope of delivery

Device	Scope of delivery
MACH102-8TP, MACH102-8TP-R, MACH102-8TP-F, MACH102-8TP-FR, MACH102-24TP-F or MACH102-24TP-FR	MACH 100 device Terminal block for signal contact Two brackets with fastening screws (pre-mounted) Housing feet, stick-on Non-heating appliance cable, Euro model CD ROM with user manual Installation user manual

## ■ Accessories

**Note:** Please note that products recommended as accessories may have characteristics that do not fully correspond to those of the corresponding product. This may limit their possible usage in the overall system.

Name	Order number
Fast ETHERNET SFP modules:	
M-FAST SFP-MM / LC	943 865-001
M-FAST SFP-SM / LC	943 866-001
M-FAST SFP-SM+/ LC	943 867-001
M-FAST SFP-LH / LC	943 868-001
Gigabit ETHERNET SFP modules:	

Name	Order number
M-SFP-SX/LC	943 014-001
M-SFP-LX/LC	943 015-001
M-SFP-LH/LC	943 042-001
M-SFP-LH+/LC	943 049-001
Pocket Guide	280 710-851
AutoConfiguration Adapter ACA 21-USB	943 271-001
Terminal cable	943 301-001
2-pin terminal block (50 units)	943 845-010
Bracket for fastening the housing	943 943-001
HiVision Network Management software	943 471-100
Industrial HiVision Network Management software, operator edition	943 156-xxx
OPC Server software HiOPC	943 055-001

## ■ Underlying norms and standards

Name	
EN 61000-6-2:2005	Generic norm – immunity in industrial environments
EN 55022:2006	IT equipment – radio interference characteristics
IEC/EN 60950-1:2006	Safety for the installation of IT equipment
FCC 47 CFR Part 15:2006	Code of Federal Regulations

*Table 8: List of norms and standards. Certified devices are marked with a certification indicator. From the imprint on the device label you will see the current certification status of your device.*

RFC 768	UDP	RFC 1769	SNTP
RFC 783	TFTP	RFC 1907	MIB2
RFC 791	IP	RFC 1945	HTTP/1.0
RFC 792	ICMP	RFC 2131	DHCP
RFC 793	TCP	RFC 2132	DHCP Options
RFC 826	ARP	RFC 2236	IGMPv2
RFC 951	BOOTP	RFC 2239	MAU-MIB
RFC 1112	IGMPv1	RFC 3411	SNMP Framework
RFC 1157	SNMPv3	RFC 3412	SNMP MDP
RFC 1155	SMIv1	RFC 3413	SNMP Applications
RFC 1213	MIB2	RFC 3414	SNMP USM
RFC 1493	Dot1d	RFC 3415	SNMP VACM
RFC 1542	BOOTP Extensions	RFC 2613	SMON
RFC 1757	RMON	RFC 2674	Dot1p/Q

*Table 9: List of RFCs*

IEEE 802.1 D	Switching, GARP, GMRP, Spanning Tree
IEEE 802.1 D-1998	Media access control (MAC) bridges (includes IEEE 802.1p Priority and Dynamic Multicast Filtering, GARP, GMRP)
IEEE 802.1 Q	Tagging
IEEE 802.1 Q-1998	Virtual Bridged Local Area Networks (VLAN Tagging, GVRP)
IEEE 802.1 w.2001	Rapid Reconfiguration
IEEE 802.3-2002	Ethernet

*Table 10: List of IEEE standards*

## ■ Certifications

The following table shows the status of the certification of the equipment.

Standard	
cUL 508 / CSA C22.2 No.142	pending
cUL 60950-1	pending

*Table 11: Certifications - for the current status, visit [www.hirschmann.com](http://www.hirschmann.com)*



# Weitere Unterstützung

## ■ Technische Fragen und Schulungsangebote

Bei technischen Fragen wenden Sie sich bitte an den Hirschmann Vertragspartner in Ihrer Nähe oder direkt an Hirschmann. Die Adressen unserer Vertragspartner finden Sie im Internet unter [www.hirschmann-ac.com](http://www.hirschmann-ac.com).

Darüber hinaus steht Ihnen unsere **Hotline** zur Verfügung:

- ▶ Tel. +49 (0)1805 14-1538
- ▶ Fax +49 (0)7127 14-1551

Antworten zu häufig gestellten Fragen finden Sie in den Internetseiten von Hirschmann ([www.hirschmann-ac.com](http://www.hirschmann-ac.com)) am Ende der Produktseiten in der Rubrik FAQ.

Das aktuelle Schulungsangebot zu Technologie und Produkten finden Sie unter <http://www.hicomcenter.com>.

## ■ Hirschmann Competence Center

Langfristig garantieren hervorragende Produkte allein keine erfolgreiche Kundenbeziehung. Erst der umfassende Service macht weltweit den Unterschied. In dieser globalen Konkurrenz hat das Hirschmann Competence Center mit dem kompletten Spektrum innovativer Dienstleistungen vor den Wettbewerbern gleich dreifach die Nase vorn:

- ▶ Das Consulting umfasst die gesamte technische Beratung von der Systembewertung über die Netzplanung bis hin zur Projektierung.
- ▶ Das Training bietet Grundlagenvermittlung, Produkteinweisung und Anwenderschulung mit Zertifizierung.
- ▶ Der Support reicht von der Inbetriebnahme über den Bereitschafts-service bis zu den Wartungskonzepten.

Mit dem Hirschmann Competence Center entscheiden Sie sich in jedem Fall gegen jeden Kompromiss. Das kundenindividuelle Angebot lässt Ihnen die Wahl, welche Servicekomponenten Sie in Anspruch nehmen. Internet:

<http://www.hicomcenter.com>.



**HIRSCHMANN**

---

A **BELDEN** BRAND