

## MIC-770

## Intel® 8<sup>th</sup> Generation Core™ i Socket Compact

## Fanless Computer

## Startup Manual

### Packing List

Before you begin installing your card, please make sure that the following items have been shipped:

1. MIC-770 bare-bone system x 1
2. Startup manual ENCNTC for MIC-770 1st Ed  
P/N: 2041077000
3. 4-pin Phoenix connector P/N: 1652003234
4. Mounting bracket x2 P/N: 1960070543T001
5. SATA cable x1 P/N: 1700013095
6. SATA power cable x 1 P/N: 1700024372-01

If any of these items are missing or damaged, please contact your distributor or sales representative immediately.

**Note:** Acrobat Reader is required to view any PDF file. Acrobat Reader can be downloaded at: [get.adobe.com/reader](http://get.adobe.com/reader) (Acrobat is a trademark of Adobe)

For more information on this and other Advantech products, please visit our website at:

<http://www.advantech.com>



For technical support and service, please visit our support website for MIC-770 at:

<https://advt.ch/mic770spt>



Register your products on our website and get 2 months extra warranty for Free at:

<http://www.register.advantech.com>



Part No. 2041077001  
Printed in China

2nd Edition  
March 2019

**Caution:** DANGER OF EXPLOSION IF BATTERY IS INCORRECTLY REPLACED. REPLACE ONLY WITH THE SAME OR EQUIVALENT TYPE RECOMMENDED BY THE MANUFACTURER, DISCARD USED BATTERIES ACCORDING TO THE MANUFACTURER'S INSTRUCTIONS.

**Attention:** DANGER D'EXPLOSION SI LA BATTERIE EST INEXACTEMENT REMPLACÉE. REMPLACEZ SEULEMENT AVEC LA MÊME CHOSE OU LE TYPE ÉQUIVALENT RECOMMANDÉ PAR LE FABRICANT, JETTENT LES BATTERIES UTILISÉES INSTRUCTIONS DE S SELON FABRICANT DES'.

### Specifications

#### Processor System

- Intel® 8<sup>th</sup> generation Core™ i socket CPU (LGA1151)

#### Memory

- Supports dual channel DDR4 SODIMM-2666 MHz, 16 GB per slot without ECC function; Max. capacity is 32GB

#### Graphics

- **Q370:** Intel® HD Graphics 630, supports DirectX 12
- **H310:** Intel® HD Graphics 610, supports DirectX 12

#### Serial Ports

- 2 x RS-232/422/485, RS-485 supports automatic flow control

#### Ethernet

- **Interface:** 10/100/1000 Mbps
- **Controller:**  
Q370 LAN1: Intel® I219LM, LAN2: Intel® i210T  
H310 LAN1: Intel® I219V, LAN2: Intel® i210T

#### Storage

- **Internal 2.5" Storage Bay:** 1
- **mSATA:** 1

#### Front I/O

- **Display:** 1 x VGA, 1 x HDMI
- **USB:** Q370: 2 x USB3.1 , 6 x USB3.0  
H310: 4 x USB 3.0 and 4 x USB 2.0
- **Serial:** 2 x RS-232/422/485
- **Audio:** Line-out/Mic-in

#### Power Requirement

- **Power type:** ATX/AT
- **Power input Voltage:** 9-36 VDC
- **Minimum Power Input:** 9VDC 16A - 36VDC 5A

This product is intended to be supplied by a UL certified power supply or UL certified DC source rated 19Vdc, 7.89A minimum, TMA 50°C minimum, if you need further assistance, please contact Advantech for further information.

## Specifications (Cont.)

### Miscellaneous

- Power Switch  
(Orange: System standby/Green: System Power boot)
- COM1 TX & RX LED; COM2 TX & RX LED; Storage Status LED

### Environment

- **Operation Temperature:**  
TDP 35W CPU: -10~50°C  
TDP 65W CPU: -10~40°C (does not support i7)  
Note: Safety Certification Test Temperature: safety max 50°C with SSD (TDP 35W CPU)
- **Storage Temperature:** -40 ~ 85°C (-40 ~ 185°F)
- **Relative Humidity:** 95% @ 40°C (non-condensing)

### Physical Characteristics

- **Dimensions (WxHxD):** 77 x 192 x 230 mm
- **Weight:** 2.8 kg (6.17 lbs)

## Jumpers and Connectors

The board has a number of jumpers that allow you to configure your system to suit your application. The table below lists the function of each of the jumpers and connectors.

Connectors	
Label	Function
VGA1	VGA Connector
HDMI1	HDMI connector
COM 12	RS-232/422/485
COM 34	RS-232
USB C1	USB 3.0
USB C2	USB 3.0
USB C3	USB3.1 and USB3.0 (Q370) or USB2.0 (H310)
LAN 1	Intel i219LM (Q370) or Intel i219V (H310)
LAN 2	Intel i210IT
Audio	Audio Jack (Line-out, Mic-in)
LED 6	COM 1/2 TX; RX; Storage device status
DC 9-36V	Power connector

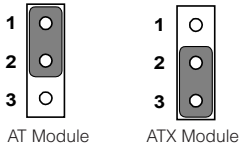

### PSO N1: System AT/ATX Module Selection

Function	Jumper Setting
1-2	AT module
2-3	ATX module (Default)

## Battery

The computer is supplied with a battery-powered realtime clock circuit. There is a danger of explosion if battery is incorrectly replaced. Replace only with same or equivalent type recommended by the manufacturer. Discard used batteries according to manufacturer's instructions.

## Declaration of Conformity

This device complies with the requirements in Part 15 of the FCC rules. Operation is subject to the following two conditions:

1. This device may not cause harmful interference.
2. This device must accept any interference received, including interference that may cause undesired operation.

## System I/O Interface

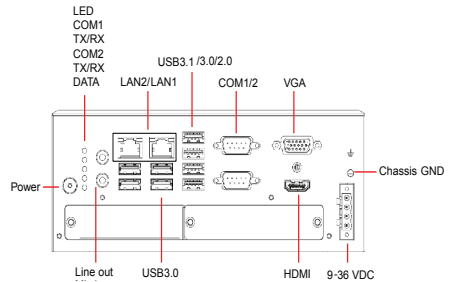

## Simple Maintenance Process

### Memory Installation

MIC-770 supports DDR4 SO-DIMM non-ECC type memory module. If you need a detailed memory support list, please contact your distributor or sales representative to order compatible memory modules.

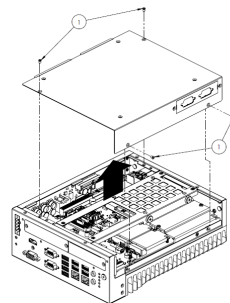

## Simple Maintenance Process (Cont.)

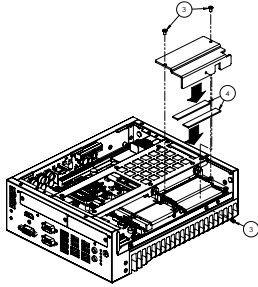

1. Undo 4 screws and remove the bottom cover.
2. Undo 4 screws to remove the storage tray.
3. Undo 3 screws to remove memory thermal cover.
4. Affix thermal pad (P/N: 1990019498N000) on memory and assemble memory.

**Note :** Thermal pad and memory thermal cover must be fully mated and compacted.

### Storage Installation

1. Undo 4 screws and remove the bottom cover.
2. Undo 4 screws to remove storage tray.
3. Secure storage with 4 x screws (P/N:1930002235).
4. Assemble SATA cable/power cable and replace storage tray securely with 4 x screws.
5. Replace bottom cover.

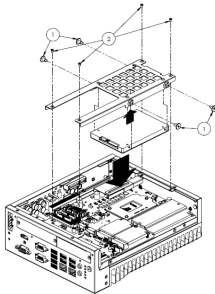

### Mini-PCIE Installation

MIC-770 supports one full size Mini-PCIE.

1. Undo 4 screws and remove the bottom cover.
2. Install the module in the Mini-PCIE socket and secure with screws.
3. Replace bottom cover and secure with screws.

### Internal USB 2.0 Installation

1. Undo 4 screws and remove the bottom cover.
2. Loosen the screw and adjust bracket size in accordance with USB dongle size.
3. Install USB dongle in the first socket. Only first socket has function.
4. Secure the screw and replace bottom cover and secure with screws.

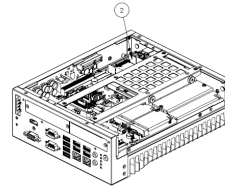

### CPU Installation

1. Undo 4 screws and remove the bottom cover.
2. Undo 4 screws to remove storage tray.
3. Undo 4 screws in the corner of the chassis.
4. Undo 4 screws around the CPU to release AL heatsink.
5. Remove AL heatsink and install CPU.
6. Smear thermal grease onto CPU.
7. Replace AL heatsink, storage tray, and bottom cover.

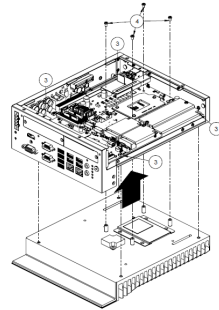

### Mounting Kit Installation

1. Take the mounting kit from the accessory box.
2. Secure with 4 x screws (P/N: 1930007259-01, M4x4L F/S D=8.5 H=1.5 (2+) ST/H BZn-NK) and install the system on table.

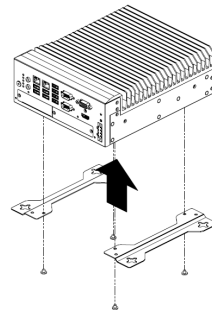

## Safety Instructions

1. Read these safety instructions carefully.
2. Keep this Startup Manual for later reference.
3. Disconnect this equipment from any AC outlet before cleaning. Use a damp cloth. Do not use liquid or spray detergents for cleaning.
4. For plug-in equipment, the power outlet socket must be located near the equipment and must be easily accessible.
5. Keep this equipment away from humidity.
6. Put this equipment on a reliable surface during installation. Dropping it or letting it fall may cause damage.
7. The openings on the enclosure are for air convection. Protect the equipment from overheating. **DO NOT COVER THE OPENINGS.**
8. Make sure the voltage of the power source is correct before connecting the equipment to the power outlet.
9. Position the power cord so that people cannot step on it. Do not place anything over the power cord.
10. All cautions and warnings on the equipment should be noted.
11. If the equipment is not used for a long time, disconnect it from the power source to avoid damage by transient overvoltage.
12. Never pour any liquid into an opening. This may cause fire or electrical shock.
13. Never open the equipment. For safety reasons, the equipment should be opened only by qualified service personnel.
14. If one of the following situations arises, get the equipment checked by service personnel:
  - The power cord or plug is damaged.
  - Liquid has penetrated into the equipment.
  - The equipment has been exposed to moisture.
  - The equipment does not work well, or you cannot get it to work according to the user's manual.
  - The equipment has been dropped and damaged.
  - The equipment has obvious signs of breakage.
15. **DO NOT LEAVE THIS EQUIPMENT IN AN ENVIRONMENT WHERE THE STORAGE TEMPERATURE MAY GO BELOW -40°C (-40°F) OR ABOVE 85°C (185°F). THIS COULD DAMAGE THE EQUIPMENT. THE EQUIPMENT SHOULD BE IN A CONTROLLED ENVIRONMENT.**
16. **CAUTION: DANGER OF EXPLOSION IF BATTERY IS INCORRECTLY REPLACED. REPLACE ONLY WITH THE SAME OR EQUIVALENT TYPE RECOMMENDED BY THE MANUFACTURER, DISCARD USED BATTERIES ACCORDING TO THE MANUFACTURER'S INSTRUCTIONS.**
17. The sound pressure level at the operator's position according to IEC 704-1:1982 is no more than 70 dB (A).
18. **RESTRICTED ACCESS AREA:** The equipment should only be installed in a Restricted Access Area.
19. **DISCLAIMER:** This set of instructions is given according to IEC 704-1. Advantech disclaims all responsibility for the accuracy of any statements contained herein.

# IO Connectors

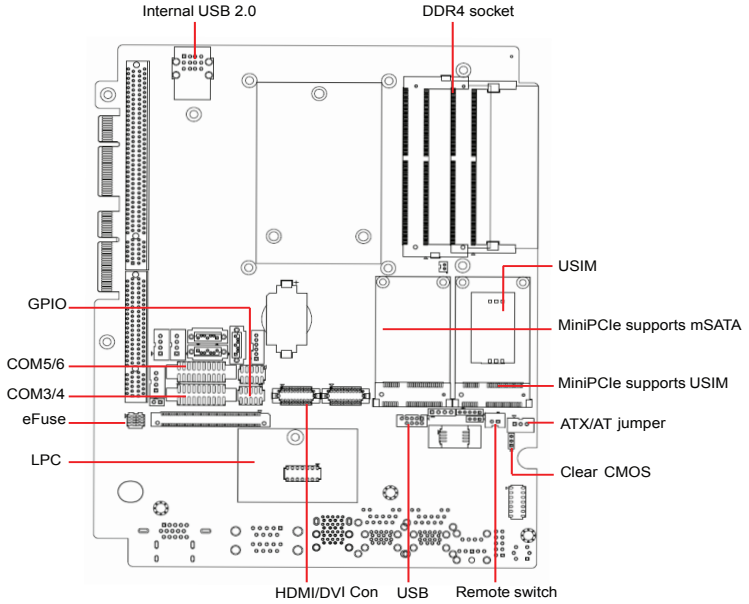

# System Dimensions

UNIT : mm

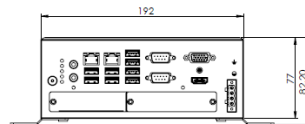
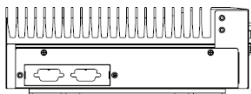
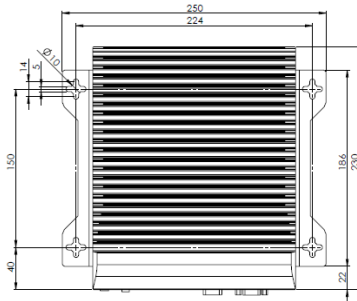
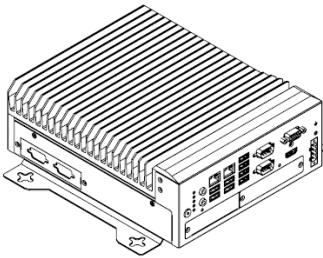

## MIC-770

### 搭载Intel® 第八代Core i插槽的紧凑型无风扇计算机

### 快速入门手册

#### 包装清单

安装系统之前，用户需确认包装中含有下面所列各项：

- |                    |                     |
|--------------------|---------------------|
| 1. MIC-770准系统x1    |                     |
| 2. MIC-770快速入门手册x1 | P/N: 2041077000     |
| 3. 4针Phoenix接口     | P/N: 1652003234     |
| 4. 安装支架x2          | P/N: 1960070543T001 |
| 5. SATA电缆x1        | P/N: 1700013095     |
| 6. SATA电源线x1       | P/N: 1700024372-01  |

如果其中任何一项缺失或损坏，请立即与经销商或销售代表联系。

注： 阅读PDF文件需要使用Acrobat Reader。用户可从以下路径下载Acrobat Reader: [get.adobe.com/reader](http://get.adobe.com/reader) (Acrobat is a trademark of Adobe)

如需更多有关这款产品及其它研华产品的信息，请访问研华网站：

<http://www.advantech.com.cn>



如需技术支持和服务，请访问研华支持网站的 MIC-770 页面：

<https://advt.ch/mic770spt>



请在研华网站注册您的产品，即可免费获得两个月额外保修服务：

<http://www.register.advantech.com>



本手册适用于MIC-770系列Rev. A1。

料号：2041077001  
中国印刷

第二版  
2019年3月

#### 产品规格

##### 处理器系统

- Intel®第八代Core i插槽CPU (LGA1151)

##### 内存

- 支持双通道DDR4 SO-DIMM-2666 MHz，每个插槽可支持16 GB（不支持ECC功能）；最大容量可达32 GB

##### 显示

- Q370: Intel® HD Graphics 630, 支持DirectX 12
- H310: Intel® HD Graphics 610, 支持DirectX 12

##### 串行端口

- 2 x RS-232/422/485, RS-485支持自动流控功能

##### 以太网

- 接口：10/100/1000 Mbps
- 控制器：  
Q370 LAN1: Intel I219LM, LAN2: Intel i210IT  
H310 LAN1: Intel I219V, LAN2: Intel i210IT

##### 存储

- 内置2.5” 存储装置托架：1
- mSATA：1

##### 前部I/O

- 显示：1 x VGA, 1 x HDMI
- USB：  
Q370: 2 x USB3.1 , 6 x USB3.0  
H310: 4 x USB 3.0和4 x USB 2.0
- 串行端口：2 x RS-232/422/485
- 音频：线路输出/麦克输入

##### 电源要求

- 电源类型：ATX/AT
- 输入电压：9-36 VDC
- 最小电源输入：9VDC 16A - 36VDC 5A

##### 其它

- 电源开关（橙色：系统待机/绿色：系统电源启动）
- COM1 TX & RX LED; COM2 TX & RX LED; 存储装置状态LED

##### 环境规格

- 工作温度：  
TDP 35W CPU: -10 ~ 50° C  
TDP 65W CPU: -10 ~ 40° C (不支持i7)
- 储存温度：-40 ~ 85° C (-40 ~ 185° F)
- 相对湿度：95% @ 40° C (非凝结)

##### 物理规格

- 尺寸 (W x H x D)：77 x 192 x 230 mm
- 重量：2.8 kg (6.17 lbs)

## 跳线和接口

主板上有很多跳线允许用户配置系统，满足各种不同应用需求。下表为每个跳线和接口的功能列表。

接口	功能
标签	功能
VGA1	VGA接口
HDMI1	HDMI接口
COM 12	RS-232/422/485
COM 34	RS-232
USB C1	USB 3.0
USB C2	USB 3.0
USB C3	USB3.1 和 USB3.0 (Q370) 或 USB2.0 (H310)
LAN 1	Intel i219LM (Q370) 或 Intel i219V (H310)
LAN 2	Intel i210IT
Audio	音频插孔（线路输出、麦克输入）
LED 6	COM 1/2 TX; RX; 存储装置状态
DC 9-36V	电源接口

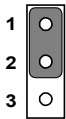

AT模块

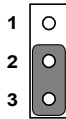

ATX模块

### PSO1: 系统AT/ATX模块选择

功能	跳线设置
1-2	AT模块
2-3	ATX模块（默认）

## 电池

计算机配置了由电池供电的实时时钟电路，如果 电池更换不正确，将有爆炸的危险。因此，只可以使用制造商推荐的同一种或者同等型号的电池进行替换。请按照制造商的指示处理旧电池。

## 符合性声明

本品符合FCC规则第15款限制。操作符合下列两种情况：

1. 此装置不可产生干扰，且
2. 此装置必须接受任何干扰，包括可能导致非预期造作的干扰。

## 系统I/O接口

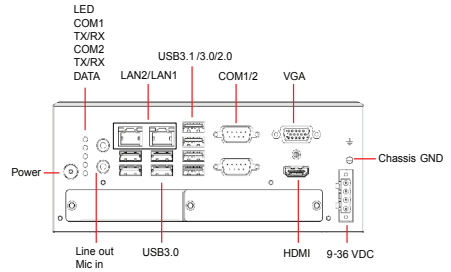

## 简单安装步骤

### 内存安装

MIC-770支持DDR4 S0-DIMM非ECC内存模块。如需详细的内存支持列表，请联系您的经销商或销售代表以订购兼容的内存模块。

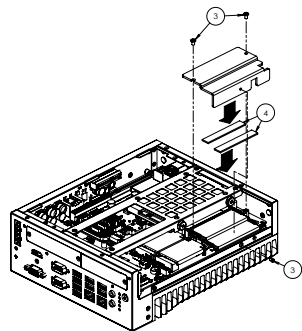
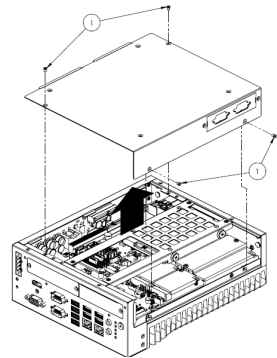

## 简单安装步骤（续）

1. 卸下4颗螺丝并移除底盖。
2. 卸下4颗螺丝并移除储存装置托架。
3. 卸下3颗螺丝并移除内存散热盖。
4. 将导热垫片（P/N: 1990019498N000）在内存上，再安装内存模块。

注：导热垫片必须完全贴合并压实于内存散热盖上。

### 储存装置安装

1. 卸下4颗螺丝并移除底盖。
2. 卸下4颗螺丝并移除储存装置托架。
3. 拧紧4颗螺丝（P/N: 1930002235）。
4. 连接SATA电缆/电源线，之后将储存装置托架放回并用螺丝固定。
5. 放回底盖并用螺丝固定。

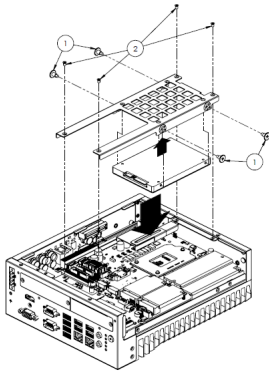

### CPU安装

1. 卸下4颗螺丝并移除底盖。
2. 卸下4颗螺丝并移除储存装置托架。
3. 卸下机箱四个角的4颗螺丝。
4. 卸下CPU周围的4颗螺丝以释放铝挤散热片。
5. 移除铝挤散热片并安装CPU。
6. 将散热膏涂于CPU。
7. 重新放回并固定铝挤散热片、储存装置托架和底盖。

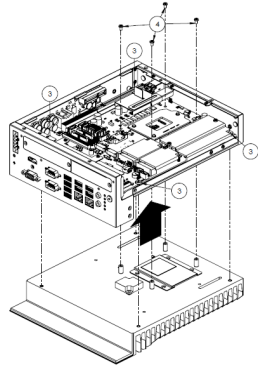

### 支架安装

1. 将支架从附件盒中取出。
2. 拧紧4颗螺丝（P/N: 1930007259-01, M4x4L F/S D=8.5 H=1.5 (2+) ST/H BZn-NK）并将系统安装于平面之上。

### Mini-PCIE安装

MIC-770支持一块全长Mini-PCIE。

1. 卸下4颗螺丝并移除底盖。
2. 将模块安装在Mini-PCIE插槽，并用螺丝固定。
3. 放回底盖并用螺丝固定。

### 内置USB 2.0安装

1. 卸下4颗螺丝并移除底盖。
2. 拧松螺丝，并根据USB装置大小调整支架。
3. 安装USB装置。请注意只能使用第一个插孔。
4. 放回底盖并用螺丝固定。

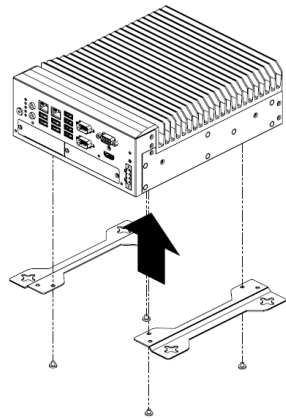
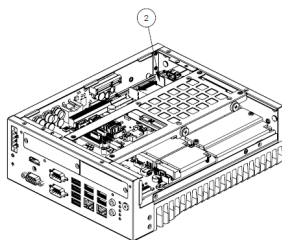



# I/O接口

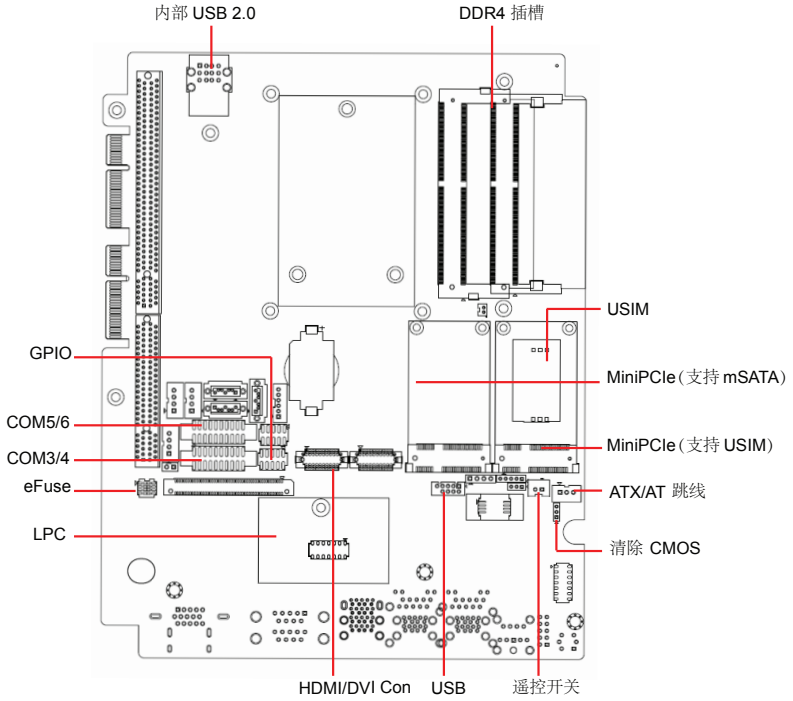

# 产品尺寸

单位 : mm

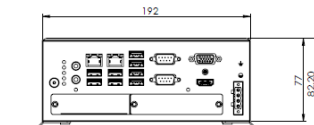
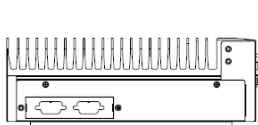
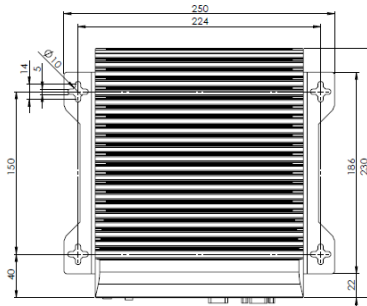
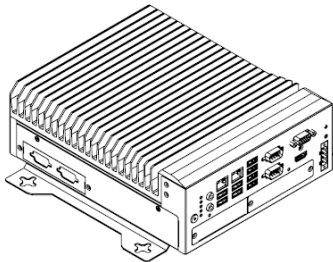

## MIC-770

# 搭載Intel® 第八代Core i處理器的緊湊型無風扇計算機 快速入門手冊

### 包裝清單

安裝系統之前，使用者需確認包裝中含有下面所列各項：

1. MIC-770準系統x1
2. MIC-770快速入門手冊x1 P/N: 2041077000
3. 4針Phoenix電源接頭 P/N: 1652003234
4. 安裝支架x2 P/N: 1960070543T001
5. SATA訊號線x1 P/N: 1700013095
6. SATA電源線x1 P/N: 1700024372-01

如果其中任何一項缺失或損壞，請立即與經銷商或業務代表聯繫。

註： 閱讀PDF檔需要使用Acrobat Reader。使用者可從以下路徑下載Acrobat Reader: [get.adobe.com/reader](http://get.adobe.com/reader) (Acrobat is a trademark of Adobe)

如需更多有關這款產品及其它研華產品的資訊，請訪問研華網站：

<http://www.advantech.tw>



如需技術支援和服務，請訪問研華支援網站的 MIC-770 頁面：

<https://adv.t.ch/mic770st>



請在研華網站註冊您的產品，即可免費獲得兩個月額外保修服務：

<http://www.register.advantech.com>



本手冊适用于MIC-770系列Rev. A1。

料號：2041077001  
中國印刷

第二版  
2019年3月

### 產品規格

#### 處理器

- Intel®第八代Core i處理器CPU (LGA1151)

#### 記憶體

- 支援雙通道DDR4 SO-DIMM-2666 MHz，每個插槽可支援16 GB（不支援ECC功能）；最大容量可達32 GB

#### 顯示

- Q370: Intel® HD Graphics 630，支援DirectX 12
- H310: Intel® HD Graphics 610，支援DirectX 12

#### 序列埠

- 2 x RS-232/422/485，RS-485支援自動流控功能

#### 乙太網

- 接頭：10/100/1000 Mbps
- 控制器：  
Q370 LAN1: Intel I219LM, LAN2: Intel i210IT  
H310 LAN1: Intel I219V, LAN2: Intel i210IT

#### 儲存裝置

- 內置2.5” 儲存裝置托架：1
- mSATA：1

#### 前部I/O

- 顯示：1 x VGA，1 x HDMI
- USB：  
Q370: 2 x USB3.1，6 x USB3.0  
H310: 4 x USB 3.0和4 x USB 2.0
- 序列埠：2 x RS-232/422/485
- 音訊：線路輸出/麥克風輸入

#### 電源

- 電源類型：ATX/AT
- 輸入電壓：9-36 VDC
- 最小電源輸入：9VDC 16A - 36VDC 5A

#### 其它

- 電源開關（橙色：系統待機/綠色：系統電源啟動）
- COM1 TX & RX LED; COM2 TX & RX LED; 儲存裝置狀態LED

#### 環境規格

- 工作溫度：  
TDP 35W CPU: -10 ~ 50° C  
TDP 65W CPU: -10 ~ 40° C (不支援i7處理器)
- 儲存溫度：-40 ~ 85° C (-40 ~ 185° F)
- 相對濕度：95% @ 40° C (非凝結)

#### 物理規格

- 尺寸 (W x H x D)：77 x 192 x 230 mm
- 重量：2.8 kg (6.17 lbs)

主機板上有很多跳線允許使用者配置系統，滿足各種不同應用需求。下表為每個跳線和介面的功能清單。

## 跳線和接頭

### 接頭

標籤	功能
VGA1	VGA接頭
HDMI1	HDMI接頭
COM 12	RS-232/422/485
COM 34	RS-232
USB C1	USB 3.0
USB C2	USB 3.0
USB C3	USB3.1 and USB3.0 (Q370) 或USB2.0 (H310)
LAN 1	Intel i219LM (Q370) 或Intel i219V (H310)
LAN 2	Intel i210IT
Audio	音訊插孔 (線路輸出、麥克風輸入)
LED 6	COM 1/2 TX; RX; 儲存裝置狀態
DC 9-36V	電源接頭

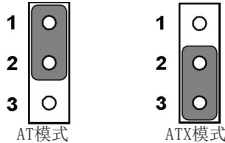

### PSON1: 系統AT/ATX模式選擇

功能	跳線設置
1-2	AT模式
2-3	ATX模式 (預設)

## 電池

電腦配置了由電池供電的即時時鐘電路，如果電池更換不正確，將有爆炸的危險。因此，只可以使用製造商推薦的一種或者同等型號的電池進行替換。請按照製造商的指示處理舊電池。

警告使用者：

這是甲類資訊產品，在居住的環境中使用時，可能會造成射頻干擾，在這種情況下，使用者會被要求採取某些適當對策。

產品於國內裝置使用時，其電源僅限使用機架電源模組所提供直流電源輸入，不得使用交流電源及附加其他電源轉換裝置提供電源，其電源輸入電壓及電流請依說明書規定使用

## 符合性聲明

本品符合FCC規則第15款限制。操作符合下列兩種情況：

1. 此裝置不可產生干擾，且
2. 此裝置可以接受任何干擾，包括可能導致非預期操作的干擾。

## 系統I/O接頭

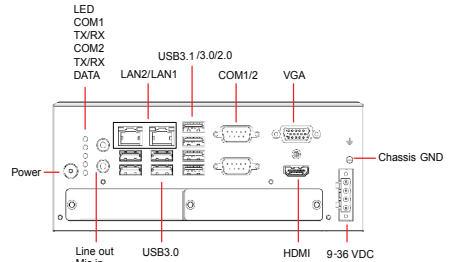

## 簡單安裝步驟

### 記憶體安裝

MIC-770支援DDR4 SO-DIMM非ECC記憶體模組。如需詳細的記憶體支援清單，請聯繫您的經銷商或業務代表以訂購相容的記憶體模組。

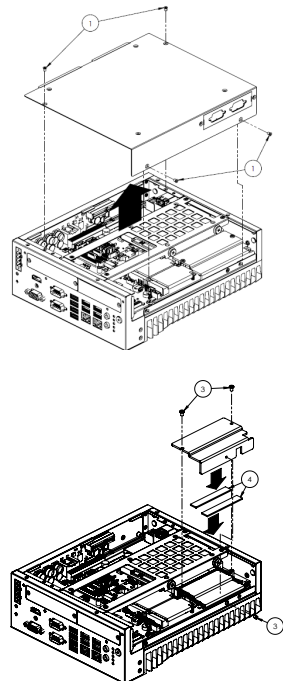

## 簡單安裝步驟（續）

1. 卸下4顆螺絲並移除底蓋。
2. 卸下4顆螺絲並移除儲存裝置托架。
3. 卸下3顆螺絲並移除記憶體散熱蓋。
4. 將導熱墊片（P/N: 1990019498N000）在記憶體上，再安裝記憶體模組。

註1: 導熱墊片必須完全貼合併壓實於記憶體散熱蓋上。

### 儲存裝置安裝

1. 卸下4顆螺絲並移除底蓋。
2. 卸下4顆螺絲並移除儲存裝置托架。
3. 擰緊4顆螺絲（1930007259-01, M4x4L F/S D=8.5 H=1.5 (2+) ST/H BZn-NK）。
4. 連接SATA電纜/電源線，之後將儲存裝置托架放回並用螺絲固定。
5. 放回底蓋並用螺絲固定。

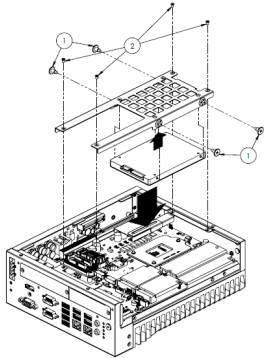

### Mini-PCIE安裝

MIC-770支援全長Mini-PCIE。

1. 卸下4顆螺絲並移除底蓋。
2. 將模組安裝在Mini-PCIE插槽，並用螺絲固定。
3. 放回底蓋並用螺絲固定。

### 內置USB 2.0安裝

1. 卸下4顆螺絲並移除底蓋。
2. 擰松螺絲，並根據USB裝置大小調整支架。
3. 安裝USB裝置。請注意只能使用第一個插孔。
4. 放回底蓋並用螺絲固定。

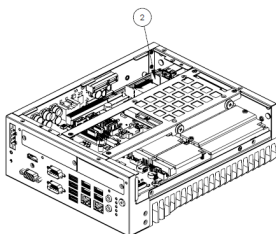

### CPU安裝

1. 卸下4顆螺絲並移除底蓋。
2. 卸下4顆螺絲並移除儲存裝置托架。
3. 卸下主機殼四個角的4顆螺絲。
4. 卸下CPU周圍的4顆螺絲以釋放鋁擠散熱片。
5. 移除鋁擠散熱片並安裝CPU。
6. 將散熱膏塗於CPU。
7. 重新放回並固定鋁擠散熱片、儲存裝置托架和底蓋。

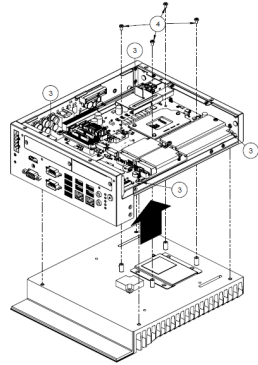

### 支架安裝

1. 將支架從附件盒中取出。
2. 擰緊4顆螺絲（P/N: 1930001069）並將系統安裝於平面之上。

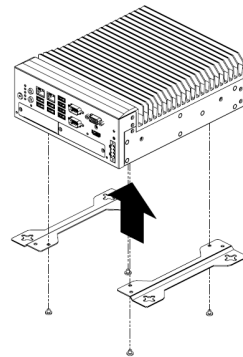

# I/O接頭

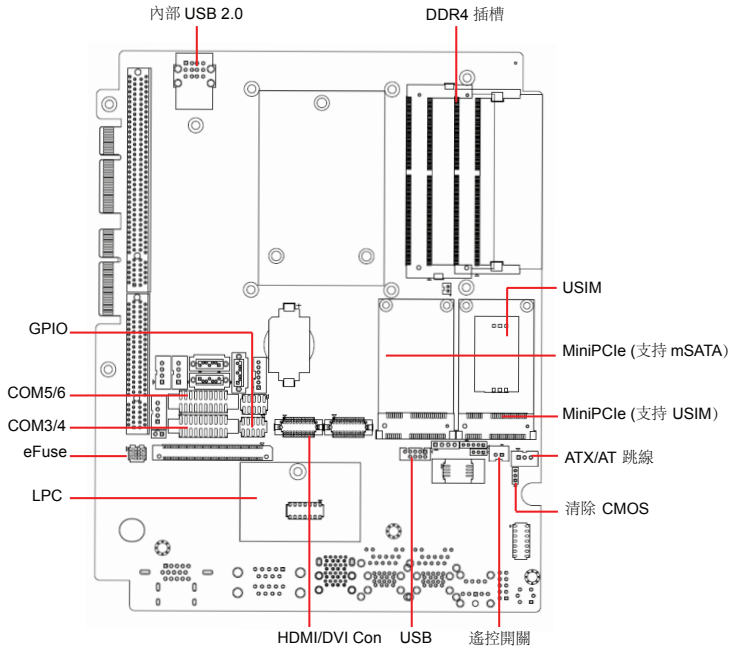

# 產品尺寸

單位 : mm

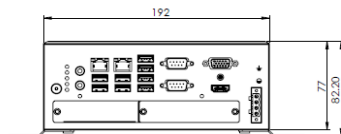
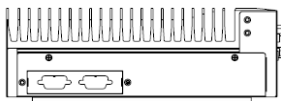
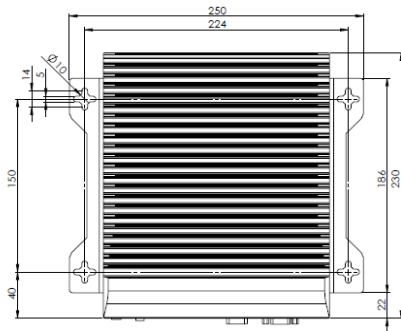
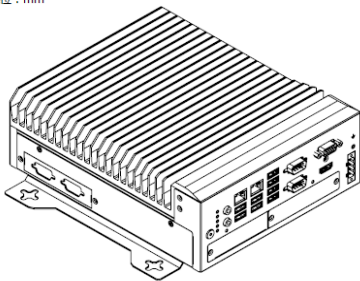

## 系列型號

MIC-770

MIC-770Q-00A1, MIC-770Q-00A2, MIC-770Q-00B1, MIC-770Q-00B2  
MIC-770H-00A1, MIC-770H-00A2, MIC-770H-00B1, MIC-770H-00B2

MIC770Q1901-T, MIC770Q1902-T, MIC770Q1903-T,  
MIC770Q1904-T, MIC770Q1905-T, MIC770Q1906-T,  
MIC770H1901-T, MIC770H1902-T, MIC770H1903-T,  
MIC770H1904-T, MIC770H1905-T, MIC770H1906-T,

MIC770Q2001-T, MIC770Q2002-T, MIC770Q2003-T,  
MIC770Q2004-T, MIC770Q2005-T, MIC770Q2006-T,  
MIC770H2001-T, MIC770H2002-T, MIC770H2003-T,  
MIC770H2004-T, MIC770H2005-T, MIC770H2006-T,

MIC770Q2101-T, MIC770Q2102-T, MIC770Q2103-T,  
MIC770Q2104-T, MIC770Q2105-T, MIC770Q2106-T,  
MIC770H2101-T, MIC770H2102-T, MIC770H2103-T,  
MIC770H2104-T, MIC770H2105-T, MIC770H2106-T,

MIC770Q2201-T, MIC770Q2202-T, MIC770Q2203-T,  
MIC770Q2204-T, MIC770Q2205-T, MIC770Q2206-T,  
MIC770H2201-T, MIC770H2202-T, MIC770H2203-T,  
MIC770H2204-T, MIC770H2205-T, MIC770H2206-T,

MIC770Q2301-T, MIC770Q2302-T, MIC770Q2303-T,  
MIC770Q2304-T, MIC770Q2305-T, MIC770Q2306-T,  
MIC770H2301-T, MIC770H2302-T, MIC770H2303-T,  
MIC770H2304-T, MIC770H2305-T, MIC770H2306-T,

MIC770Q2401-T, MIC770Q2402-T, MIC770Q2403-T,  
MIC770Q2404-T, MIC770Q2405-T, MIC770Q2406-T,  
MIC770H2401-T, MIC770H2402-T, MIC770H2403-T,  
MIC770H2404-T, MIC770H2405-T, MIC770H2406-T,

## 安全指示

1. 請仔細閱讀此安全操作說明。
2. 請妥善保存此用戶手冊供日後參考。
3. 用濕抹布清洗設備前，請確認拔除電源線。請勿使用液體或去污噴霧劑清洗設備。
4. 對於使用電源線的設備，設備周圍必須有容易接觸到的電源插座。
5. 請勿在潮濕環境中使用設備。
6. 請在安裝前確保設備放置在可靠的平面上，意外掉落可能會導致設備損壞。
7. 設備機殼的開孔適用於空氣對流，從而防止設備過熱。請勿覆蓋開孔。
8. 當您連接設備到電源插座前，請確認電源插座的電壓符合要求。
9. 請將電源線布置在人們不易絆倒的位置，請勿在電源線上覆蓋任何雜物。
10. 請注意設備上所有的警告標示。
11. 如果長時間不使用設備，請拔除與電源插座的連結，避免設備被超標的電壓波動損壞。
12. 請勿讓任何液體流入通風口，以免引起火災或短路。
13. 請勿自行打開設備。為了確保您的安全，請透過經認證的工程師來打開設備。
14. 如欲下列情況，請由專業人員維修：
  - 電源線或插頭損壞；
  - 設備內部有液體流入；
  - 設備曾暴露在過度潮濕環境中使用；
  - 設備無法正常工作，或您無法透過用戶手冊來正常工作；
  - 設備摔落或損壞；
  - 設備有明顯外觀損壞。
15. 請勿將設備放置在超出建議溫度範圍的環境，即不要低於0° C(32° F) 或高於40° C(104° F)，否則可能會造成設備損壞。
16. 注意：若電池更換不正確，將有爆炸危險。因此，只可以使用製造商推薦的同一種或者同等型號的電池進行替換。請按照製造商的指示處理舊電池。
17. 根據IEC 704-1:1982規定，操作員所在位置音量不可高於70分貝。
18. 限制區域：請勿將設備安裝於限制區域使用。
19. 免責聲明：該安全指示符合IEC 704-1要求。研華公司對其內容之準確性不承擔任何法律責任。

# 限用物質含有情況標示聲明書

設備名稱： Equipment name	電腦					
	型號(型式)： MIC-770 Type designation (Type)					
單元 Unit	限用物質及其化學符號 Restricted substances and its chemical symbols					
	鉛 Lead (Pb)	汞 Mercury (Hg)	鎘 Cadmium (Cd)	六價鉻 Hexavalent chromium (Cr+6)	多溴聯苯 Polybrominated biphenyls (PBB)	多溴二苯醚 Polybrominated diphenyl ethers (PBDE)
電路板	-	○	○	○	○	○
內外殼 (外殼、內部框架...等)	○	○	○	○	○	○
其它固定組件 (螺絲、夾具、卡榫)	-	○	○	○	○	○
線材	○	○	○	○	○	○
存取裝置 (SSD)	-	○	○	○	○	○
記憶卡	-	○	○	○	○	○
電源供應器	-	○	○	○	○	○
備考1: 超出0.1 wt % 及 “超出0.01 wt %” 係指限用物質之百分比含量超出百分比含量基準值。 Note 1: Exceeding 0.1 wt % and “exceeding 0.01 wt %” indicate that the percentage content of the restricted substance exceeds the reference percentage value of presence condition. 備考2: “○” 係指該項限用物質之百分比含量未超出百分比含量基準值。 Note 2: “○” indicates that the percentage content of the restricted substance does not exceed the percentage of reference value of presence. 備考3: “-” 係指該項限用物質為排除項目。 Note 3: The “-” indicates that the restricted substance corresponds to the exemption.						