

chcoze

DX-1000 Series

User Manual



Rugged Workstation

7/6th Generation Intel® Xeon® and Core™ Processors,
Extreme Performance, Compact and Modular Rugged
Workstation

Version: V1.33

Contents

Preface

Revision.....	05
Copyright Notice.....	05
Acknowledgement.....	05
Disclaimer.....	05
Declaration of Conformity.....	05
Product Warranty Statement	06
Technical Support and Assistance.....	07
Conventions Used in this Manual	08
Safety Precaution	08
Package Contents	09
Ordering Information	09
Optional Modules & Accessories.....	10

Chapter 1 Product Introductions

1.1 Overview	12
1.2 Highlights	12
1.3 Product Pictures.....	13
1.4 Key Features	13
1.5 Hardware Specification	14
1.6 System I/O	15
1.6.1 Front	15
1.6.2 Rear	16
1.7 Mechanical Dimension	17

Chapter 2 Switches and Connectors

2.1 Location of Switches and Connectors	19
2.1.1 Top View	19
2.1.2 Bottom View	20
2.2 Switches and Connectors Definition.....	21
2.3 Definition of Switches.....	22
2.4 Definition of Connectors	23

Chapter 3 System Setup

3.1 Removing the Top Cover	28
3.2 Installing CPU	31
3.3 Installing SO-DIMM Memory.....	34
3.4 Installing a Mini-PCIe/mSATA Card.....	35
3.5 Installing Antennas	36

3.6	Installing a CFM-IGN Power Ignition Module.....	38
3.7	Installing a CMI-COM Module.....	40
3.8	Installing a CMI-DIO Module.....	42
3.9	Installing CMI-M12LAN Module.....	44
3.10	Installing a CFM-PoE Module.....	47
3.11	Installing Thermal Pad.....	50
3.12	Installing Top Cover.....	50
3.13	Installing Bottom Cover.....	51
3.14	Removing the Front Cover Plate.....	52
3.15	Installing a SATA Hard Drive at Front Side.....	52
3.16	Installing a SIM Card.....	55
3.17	Installing the CMOS Battery.....	56
3.18	Fastening the Cover.....	58
3.19	Installing an External Fan.....	58
3.20	Wall Mount Brackets.....	61
3.21	DIN-Rail Mount Brackets.....	62
3.22	VESA Mount.....	63
3.23	Side Mount Brackets.....	65

Chapter 4 BIOS Setup

4.1	BIOS Introduction	68
4.2	Main Setup	69
4.2.1	System Date	69
4.2.2	System Time	69
4.3	Advanced Setup	70
4.3.1	CPU Configuration	70
4.3.2	SATA And RST Configuration.....	71
4.3.3	PCH-FW Configuration.....	72
4.3.4	ACPI Settings.....	73
4.3.5	F81866 Super IO Configuration.....	74
4.3.6	Hardware Monitor.....	75
4.3.7	S5 RTC Wake Settings.....	75
4.3.8	Serial Port Console Redirection.....	76
4.3.9	Network Stack Configuration	77
4.3.10	CSM Configuration.....	77
4.3.11	USB Configuration.....	78
4.4	Chipset Setup	79
4.4.1	System Agent (SA) Configuration	79
4.4.2	PCH-IO Configuration	80
4.5	Security Setup	82
4.5.1	Administrator Password	82

4.5.2 User Password	82
4.5.3 Security Boot.....	82
4.6 Boot Setup	83
4.6.1 Setup Prompt Timeout.....	83
4.6.2 Bootup NumLock State.....	83
4.6.3 Quiet Boot	83
4.6.4 Fast Boot	83
4.7 Save & Exit	84
4.7.1 Save Changes and Exit	84
4.7.2 Discard Changes and Exit	84
4.7.3 Save Changes and Reset	84
4.7.4 Discard Changes and Reset.....	84
4.7.5 Save Changes	84
4.7.6 Discard Changes	84
4.7.7 Restore Defaults	84
4.7.8 Save as User Defaults	84
4.7.9 Restore User Defaults	84

Chapter 5 Product Application (For DIO Only)

5.1 Digital I/O (DIO) application	86
5.1.1 Digital I/O Programming Guide	86
5.2 Digital I/O (DIO) Hardware Specification	92
5.2.1 DIO Connector Definition	93

Chapter 6 Optional Modules

6.1 Location of the Connectors and Switches.....	96
6.2 CFM-IGN Connector Definition and Settings.....	96
6.3 CMI-COM Connector Definition & Settings.....	97
6.4 CMI-M12 LAN Module Pin Definitions.....	98

Preface

Revision

Revision	Description	Date
1.00	New Release	2017/10/16
1.10	Correction Made	2018/11/20
1.20	Update the Supporting Capacity of Memory to the latest	2019/11/08
1.21	Correction Made	2019/11/21
1.30	Correction Made	2019/12/18
1.31	Correction Made	2020/04/09
1.32	New Format Updated	2020/10/22
1.33	Correction Made	2020/11/13

Copyright Notice

© 2017 by Cincoze Co., Ltd. All rights are reserved. No parts of this manual may be copied, modified, or reproduced in any form or by any means for commercial use without the prior written permission of Cincoze Co., Ltd. All information and specification provided in this manual are for reference only and remain subject to change without prior notice.

Acknowledgement

Cincoze is a registered trademark of Cincoze Co., Ltd. All registered trademarks and product names mentioned herein are used for identification purposes only and may be trademarks and/or registered trademarks of their respective owners.

Disclaimer

This manual is intended to be used as a practical and informative guide only and is subject to change without notice. It does not represent a commitment on the part of Cincoze. This product might include unintentional technical or typographical errors. Changes are periodically made to the information herein to correct such errors, and these changes are incorporated into new editions of the publication.

Declaration of Conformity



FCC

This equipment has been tested and found to comply with the limits for a Class A digital device, pursuant to Part 15 of the FCC Rules. These limits are designed to provide reasonable protection against harmful interference when the equipment is operated in a commercial environment. This equipment generates, uses, and can radiate radio frequency energy and, if not installed and used in accordance with the instruction manual, may cause harmful interference to radio communications. Operation of this equipment in a

residential area is likely to cause harmful interference in which case the user will be required to correct the interference at his own expense.



CE

The product(s) described in this manual complies with all application European Union (CE) directives if it has a CE marking. For computer systems to remain CE compliant, only CE-compliant parts may be used. Maintaining CE compliance also requires proper cable and cabling techniques.

Product Warranty Statement

Warranty

Cincoze products are warranted by Cincoze Co., Ltd. to be free from defect in materials and workmanship for 2 years from the date of purchase by the original purchaser. During the warranty period, we shall, at our option, either repair or replace any product that proves to be defective under normal operation. Defects, malfunctions, or failures of the warranted product caused by damage resulting from natural disasters (such as by lightning, flood, earthquake, etc.), environmental and atmospheric disturbances, other external forces such as power line disturbances, plugging the board in under power, or incorrect cabling, and damage caused by misuse, abuse, and unauthorized alteration or repair, and the product in question is either software, or an expendable item (such as a fuse, battery, etc.), are not warranted.

RMA

Before sending your product in, you will need to fill in Cincoze RMA Request Form and obtain an RMA number from us. Our staff is available at any time to provide you with the most friendly and immediate service.

■ RMA Instruction

- Customers must fill in Cincoze Return Merchandise Authorization (RMA) Request Form and obtain a RMA number prior to returning a defective product to Cincoze for service.
- Customers must collect all the information about the problems encountered and note anything abnormal and describe the problems on the “Cincoze Service Form” for the RMA number apply process.
- Charges may be incurred for certain repairs. Cincoze will charge for repairs to products whose warranty period has expired. Cincoze will also charge for repairs to products if the damage resulted from acts of God, environmental or atmospheric disturbances, or other external forces through misuse, abuse, or unauthorized alteration or repair. If charges will be incurred for a repair, Cincoze lists all charges, and will wait for customer’s approval before performing the repair.
- Customers agree to insure the product or assume the risk of loss or damage during transit, to prepay shipping charges, and to use the original shipping

container or equivalent.

- Customers can be sent back the faulty products with or without accessories (manuals, cable, etc.) and any components from the system. If the components were suspected as part of the problems, please note clearly which components are included. Otherwise, Cincoze is not responsible for the devices/parts.
- Repaired items will be shipped along with a "Repair Report" detailing the findings and actions taken.

Limitation of Liability

Cincoze' liability arising out of the manufacture, sale, or supplying of the product and its use, whether based on warranty, contract, negligence, product liability, or otherwise, shall not exceed the original selling price of the product. The remedies provided herein are the customer's sole and exclusive remedies. In no event shall Cincoze be liable for direct, indirect, special or consequential damages whether based on contract of any other legal theory.

Technical Support and Assistance

1. Visit the Cincoze website at www.cincoze.com where you can find the latest information about the product.
2. Contact your distributor or our technical support team or sales representative for technical support if you need additional assistance. Please have following information ready before you call:
 - Product name and serial number
 - Description of your peripheral attachments
 - Description of your software (operating system, version, application software, etc.)
 - A complete description of the problem
 - The exact wording of any error messages

Conventions Used in this Manual



WARNING

This indication alerts operators to an operation that, if not strictly observed, may result in severe injury.



CAUTION

This indication alerts operators to an operation that, if not strictly observed, may result in safety hazards to personnel or damage to equipment.



NOTE

This indication provides additional information to complete a task easily.

Safety Precautions

Before installing and using this device, please note the following precautions.

1. Read these safety instructions carefully.
2. Keep this User's Manual for future reference.
3. Disconnect this equipment from any AC outlet before cleaning.
4. For plug-in equipment, the power outlet socket must be located near the equipment and must be easily accessible.
5. Keep this equipment away from humidity.
6. Put this equipment on a reliable surface during installation. Dropping it or letting it fall may cause damage.
7. Make sure the voltage of the power source is correct before connecting the equipment to the power outlet.
8. Use a power cord that has been approved for using with the product and that it matches the voltage and current marked on the product's electrical range label. The voltage and current rating of the cord must be greater than the voltage and current rating marked on the product.
9. Position the power cord so that people cannot step on it. Do not place anything over the power cord.
10. All cautions and warnings on the equipment should be noted.
11. If the equipment is not used for a long time, disconnect it from the power source to avoid damage by transient overvoltage.
12. Never pour any liquid into an opening. This may cause fire or electrical shock.

13. Never open the equipment. For safety reasons, the equipment should be opened only by qualified service personnel.
If one of the following situations arises, get the equipment checked by service personnel:
- The power cord or plug is damaged.
 - Liquid has penetrated into the equipment.
 - The equipment has been exposed to moisture.
 - The equipment does not work well, or you cannot get it work according to the user's manual.
 - The equipment has been dropped and damaged.
 - The equipment has obvious signs of breakage.
14. CAUTION: Danger of explosion if battery is incorrectly replaced. Replace only with the same or equivalent type recommended by the manufacturer.
15. Equipment intended only for use in a RESTRICTED ACCESS AREA.

Package Contents

Before installation, please ensure all the items listed in the following table are included in the package.

Item	Description	Q'ty
1	Rugged Workstation	1
2	CPU Heatsink Thermal Pad	1
3	Utility DVD Driver	1
4	Screw Pack	1
5	Wall Mounting Kit	1
6	Power Terminal Block Connector	1
7	Remote Power On/Off Terminal Block Connector	1
8	FAN Terminal Block Connector	1
9	DVI-I to VGA Adaptor	1



Note: Notify your sales representative if any of the above items are missing or damaged.

Ordering Information

Model No.	Product Description
DX-1000-R10	7/6th Generation Intel® Xeon® and Core™ Processors, Extreme Performance, Compact and Modular Rugged Workstation

Optional Modules & Accessories

Model No.	Product Description
CFM-IGN01	CFM Module with Power Ignition Sensing Control Function, Select 12V/24V
CFM-PoE01	CFM Module with PoE Control Function, Individual Port 25.5W
CMI-COM01/UB0903	CMI Module with 2x RS232/422/485, 1x Universal Bracket [97 x 18 mm]
CMI-DIO01/UB0918	CMI Module with 16x Optical Isolated DIO (8 in/8 out), 1x Universal Bracket [97 x 18 mm]
CMI-LAN01-R12/UB0912	CMI Module with 4 Intel I210-IT GbE LAN, RJ45 Port/ 1x Universal Bracket with 4x RJ45 Cutout for DX Series
CMI-M12LAN01-R12/UB0910	CMI Module with 4 Intel I210-IT GbE LAN, M12 Port/ 1x Universal Bracket with 4x M12 Cutout for DX Series
MEC-COM-M212-TD B9/UB0903	Mini-PCIe Module with 2x COM Ports/ 1x Universal Bracket [97 x 18 mm]
MEC-COM-M334-TD B9/2xUB0903	Mini-PCIe Module with 4x COM Ports/ 2x Universal Brackets [97 x 18 mm]
MEC-LAN-M102-30/UB0911	Mini-PCIe Module with 2x LAN Ports/ 1x Universal Bracket [97 x 18 mm]
MEC-USB-M102-15/UB0914	Mini-PCIe Module with 2x USB 3.0 Ports / 1x Universal Bracket [97 x 18 mm], 1x Cable for MEC-USB (15cm)
FAN-EX101	External Fan with 4pin Terminal Block Plug, Mounting Bracket, Support smart fan
GS120A24-CIN	Adapter AC/DC 24V 5.0A 120W with 3pin Terminal Block Plug 5.0mm Pitch, with Tubes, Level VI
GS220A24-CIN	Adapter AC/DC 24V 9.2A 220W with 3pin Terminal Block Plug 5.0mm Pitch, with Tubes, Level VI
Side-DX	DX Series Side Mount Kit
Din01	Dinrail Mount Kit, KMRH-K175



Chapter 1

Product Introductions

1.1 Overview

The Cincoze DX-1000 is a rugged workstation series based on LGA 1151 socket and Intel® C236 chipset supporting 7th/6th generation Intel® Xeon® and Intel® Core™ Processors, DX-1000 Series supports 4K resolution through Intel® Gen 9 graphics engine with two DDR4 SO-DIMM sockets up to 64GB memory which delivers outstanding computing performance for high-end applications.

Despite remarkably compact footprint and rich I/O including 1x DVI-I, 2x Display ports, 2x GbE LAN ports, 4x RS232/422/485 serial ports and 8x USB 3.0 ports, Cincoze provides its exclusive CMI (Combined Multiple I/O) and CFM (Control Function Module) technologies to make DX-1000 Series a highly scalable system for specific applications such as Industrial automation, transportation, machine vision, in-vehicle and mobile surveillance. DX-1000 Series can be expanded with powered serial port, optical isolated digital I/O, multiple GbE LAN, M12 connector, Power over Ethernet and power ignition sensing function through versatile modules.

Featuring wide operating temperature (-40 ~ +70°C), wide range DC power input (9~48 VDC), high tolerance to vibration and shock (5/50 Grms), rugged uni-body construction, fanless, cable-less and jumper-less design, the DX-1000 Series is ideal to be deployed in harsh environments.

1.2 Highlights



High Performance

Supports Intel® Xeon®/Core™ i7/i5/i3 processors, DX Series is specially designed to delivering workstation grade performance for multi-task applications.



Compact Size

Small footprint (3.2 liter) with rich I/O for greater connectivity, 2x front accessible HDD/SDD trays for ease of data maintenance.

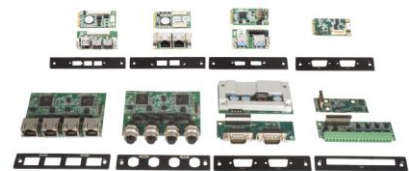

Modular Design

Unique CMI, CFM and MEC technologies for modular expansion to satisfy diversified applications.

1.3 Product pictures



Front



Rear

1.4 key Features

- Supports 7/6th Generation Intel® Xeon® / Core™ LGA1151 Socket Type Processors with Intel® C236 Chipset
- 2x DDR4-2133 SO-DIMM Sockets, up to 64GB Memory
- Triple Independent Display (1x DVI-I, 2x DisplayPort)
- 2x 2.5" Hot Swap SATA III HDD/SSD bays, Supports RAID 0/1
- 3x CMI Interfaces for RJ45/M12 GbE LAN, COM & DIO Expansions
- 2x CFM Interfaces for Power Ignition Sensing and PoE Functions
- 4x Full-size Mini-PCIe Slots for Wireless & I/O Expansions
- EN50155 / EN50121-3-2 Certification for Railway Application
- E-Mark Certification for In-vehicle Application

1.5 Hardware Specification

Processor

- 7th Generation Intel® CPU (Kaby Lake-S):
 - Intel® Core™ i3-7101TE: 3M Cache, 3.4 GHz, TDP 35W
 - Intel® Core™ i5-7500T: 6M Cache, up to 3.3 GHz, TDP 35W
 - Intel® Core™ i7-7700T: 8M Cache, up to 3.8 GHz, TDP 35W
 - Intel® Core™ i5-7500: 6M Cache, up to 3.8 GHz, TDP 65W
 - Intel® Core™ i7-7700: 8M Cache, up to 4.2 GHz, TDP 65W
 - Intel® Xeon® E3-1275 v6: 8M Cache, up to 4.2 GHz, TDP 73W
- 6th Generation Intel® CPU (Skylake-S):
 - Intel® Core™ i3-6100TE: 4M Cache, 2.7 GHz, TDP 35W
 - Intel® Core™ i5-6500TE: 6M Cache, up to 3.3 GHz, TDP 35W
 - Intel® Core™ i7-6700TE: 8M Cache, up to 3.4 GHz, TDP 35W
 - Intel® Xeon® E3-1268L v5: 8M Cache, up to 3.4 GHz, TDP 35W
 - Intel® Core™ i3-6100: 3M Cache, 3.7 GHz, TDP 51W
 - Intel® Core™ i5-6500: 6M Cache, up to 3.6 GHz, TDP 65W
 - Intel® Core™ i7-6700: 8M Cache, up to 4.0 GHz, TDP 65W
 - Intel® Xeon® E3-1225 v5: 8M Cache, up to 3.7 GHz, TDP 80W
 - Intel® Xeon® E3-1275 v5: 8M Cache, up to 4.0 GHz, TDP 80W

Chipset

- Intel® C236

BIOS

- AMI 16MB BIOS

Memory

- 2x DDR4 260-pin SO-DIMM Sockets, Support up to 64 GB (Un-buffered and Non-ECC type)

Graphics

- Integrated Intel® HD Graphics supports triple independent display (1x DVI-I, 2x DisplayPort)

Audio Codec

- Realtek® ALC888-GR • High Definition Audio

I/O Interface

- 1x DVI-I Connector (DVI: 1920 x 1080 @60Hz)
- 2x DisplayPort Connectors (3840 x 2160 @30Hz)
- 2x GbE LAN (Support WoL, Teaming, Jumbo Frame, IEEE 1588v2 and PXE), RJ45
 - GbE1: Intel I219-LM
 - GbE2: Intel I210-IT
- 4x RS-232/422/485 with Auto Flow Control (Support 5V/12V), DB9
- 8x USB 3.0 (Type-A)
- 1x Line-out & 1x Mic-in, Phone Jack 3.5mm
- 1x ATX Power On/Off Button
- 1x Reset Button
- 1x AT/ATX Mode Switch
- 1x Clear CMOS Switch
- 1x Remote Power On/Off Connector, 2-pin Terminal Block
- 1x External FAN Connector, 4-pin Terminal Block (supports smart fan by BIOS)

Expansion

- Supports CFM (Control Function Module) Technology
 - CFM IGN Module, CFM PoE Module
- Support CMI (Combined Multiple I/O) Technology
 - 4x RJ45 GbE LAN Module, 4x M12 GbE LAN Module (via 2x High Speed CMI Interfaces)
 - 2x COM Module, 16x Optical Isolated DIO Module (via 1x Low Speed CMI Interface)
- 4x Full-size Mini-PCIe Sockets
- 1x SIM Socket

Storage

- 2x SATA III (6Gbps) for 2.5" HDD/SSD

- 4x mSATA (Shared by Mini-PCIe socket) (Gen3)

- Supports S/W RAID 0, 1, 5 & 10

Other Function

- Support Instant Reboot Technology (0.2 sec)
- SuperCap Integrated for CMOS Battery Maintenance-free Operation
- Watchdog Timer: Software Programmable Supports 256 Levels System Reset

Power Requirement

- Supports AT/ATX Power Type
- Power Input Voltage 9~48VDC
- 3-pin Terminal Block
- Power Adapter AC/DC 24V/5A 120W or 24V/9.2A 220W (Optional)

Physical

- Dimension (WxDxH): 242 x 174 x 77 mm
- Weight: 3.6 kg
- Extruded Aluminum with Heavy Duty Metal
- Wall Mount / VESA Mount / DIN Rail Mount / Side Mount
- Unibody Chassis
- Fanless Design
- Jumper-less Design
- Cable less Design

Protection

- Reverse Power Input Protection
- Over Voltage Protection
 - Protection Range: 51~58V
 - Protection Type: shut down operating voltage, re-power on at the present level to recover
- Over Current Protection: 15A
- ESD Protection: +/-8kV (air), +/-4kV (contact)
- Surge Protection: 3.84kV (impedance 12 ohm 1.2/50µs waveform)

Operating System

- 7th Generation Intel® CPU (Kaby Lake-S): Windows® 10
- 6th Generation Intel® CPU (Skylake-S): Windows® 10 / 8.1 / 7
- Linux: Supports by project

Environment

- Operating Temperature:
 - 7th Generation Intel® CPU (Kaby Lake-S)
 - 35W TDP CPU: -40°C to 50°C
 - 51W~65W TDP CPU: -40°C to 45°C
 - 73W TDP CPU: -40°C to 40°C
 - 6th Generation Intel® CPU (Skylake-S)
 - 35W TDP CPU: -40°C to 70°C
 - 51W~65W TDP CPU: -40°C to 55°C
 - 80W TDP CPU: -40°C to 40°C(With Extended Temperature Peripherals; Ambient with Air Flow; According to IEC60068-2-1, IEC60068-2-2, IEC60068-2-14)
- Storage Temperature: -40°C to 85°C
- Relative Humidity: 40°C @ 95% RH (non-Condensing)
- Shock: Operating, 50 Grms, Half-sine 11 ms Duration (w/ SSD, according to IEC60068-2-27)
- Vibration: Operating, 5 Grms, 5-500 Hz, 3 Axes (w/ SSD, according to IEC60068-2-64)
- EMC: CE, FCC Class A
- Safety: LVD (EN60950-1)
- Fire Protection: EN45545-2
- Railway: EN50155, EN50121-3-2
- In-Vehicle: E-Mark (E13, No. 10R-0514546)
- MTBF: 457,941 Hours
- Database: Telcordia SR-332 Issue 3, Method 1, Case 3

1.6 System I/O

1.6.1 Front

ATX Power On/Off

Used to power-on or power-off the system

Display Port

Used to connect a monitor with DisplayPort interface

Power LED

Indicates the power status of the system

HDD LED

Indicates the status of the hard drive

IGN LED

Indicates the status of the IGN function

Temperature LED

Indicates the temperature of the system

Universal I/O Bracket

Used to customized I/O output with optional modules

IGN Setting Switch

Used to set up IGN function

USB3.0 Port

Used to connect to USB 3.0/2.0/1.1 compatible devices

AT/ATX Mode Select Switch

Used to select AT or ATX power mode

Reset Button

Used to reset the system

Clear CMOS

Used to clear CMOS to reset BIOS

Removable 2.5" SATA HDD/SSD Bay

Used to insert a 2.5" SATA HDD/SSD

SIM Card Slot

Used to insert a SIM card

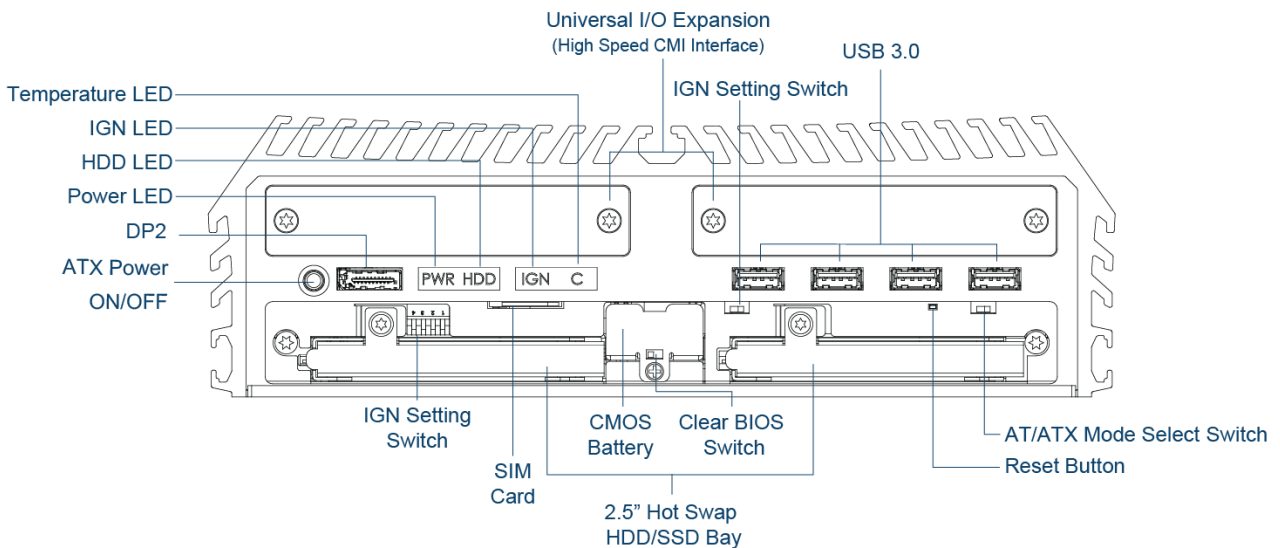

1.6.2 Rear

DC IN

Used to plug a DC power input with terminal block

Antenna Hole

Used to connect an antenna for optional wireless module

LAN

Used to connect to local area network

Display Port

Used to connect a monitor with DisplayPort interface

DVI-I Port

Used to connect a DVI monitor or connect optional split cable for dual display mode

COM Port

Used to connect to RS-232/422/485 serial devices

Remote Power On/Off

A terminal block used to connect to remote power on/off switch

Mic-In

Used to connect a microphone

Line-Out

Used to connect a speaker

Universal I/O Bracket

Used to customized I/O output with optional modules

USB3.0 Port

Used to connect to USB 3.0/2.0/1.1 compatible devices

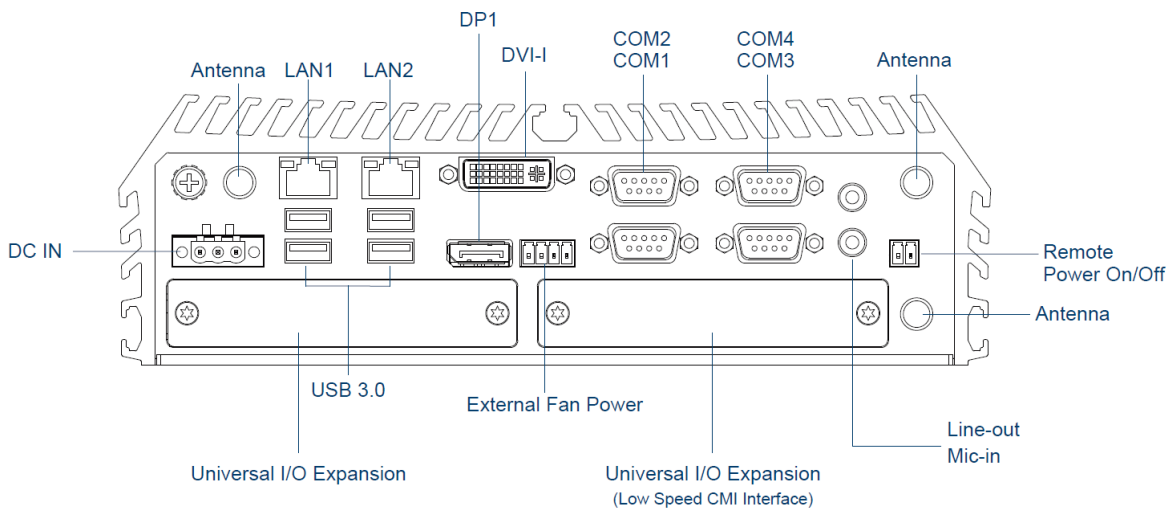

1.7 Mechanical Dimension

Unit: mm

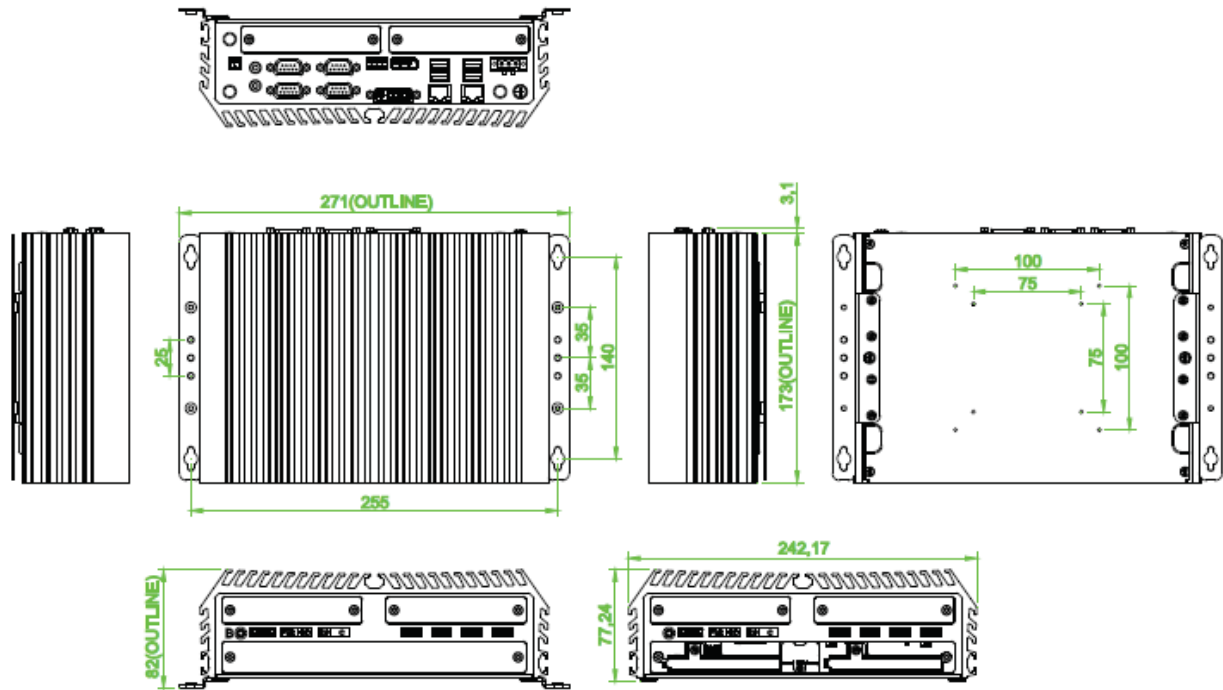



Chapter 2

Switches & Connectors

2.1 Location of Switches and Connectors

2.1.1 Top View

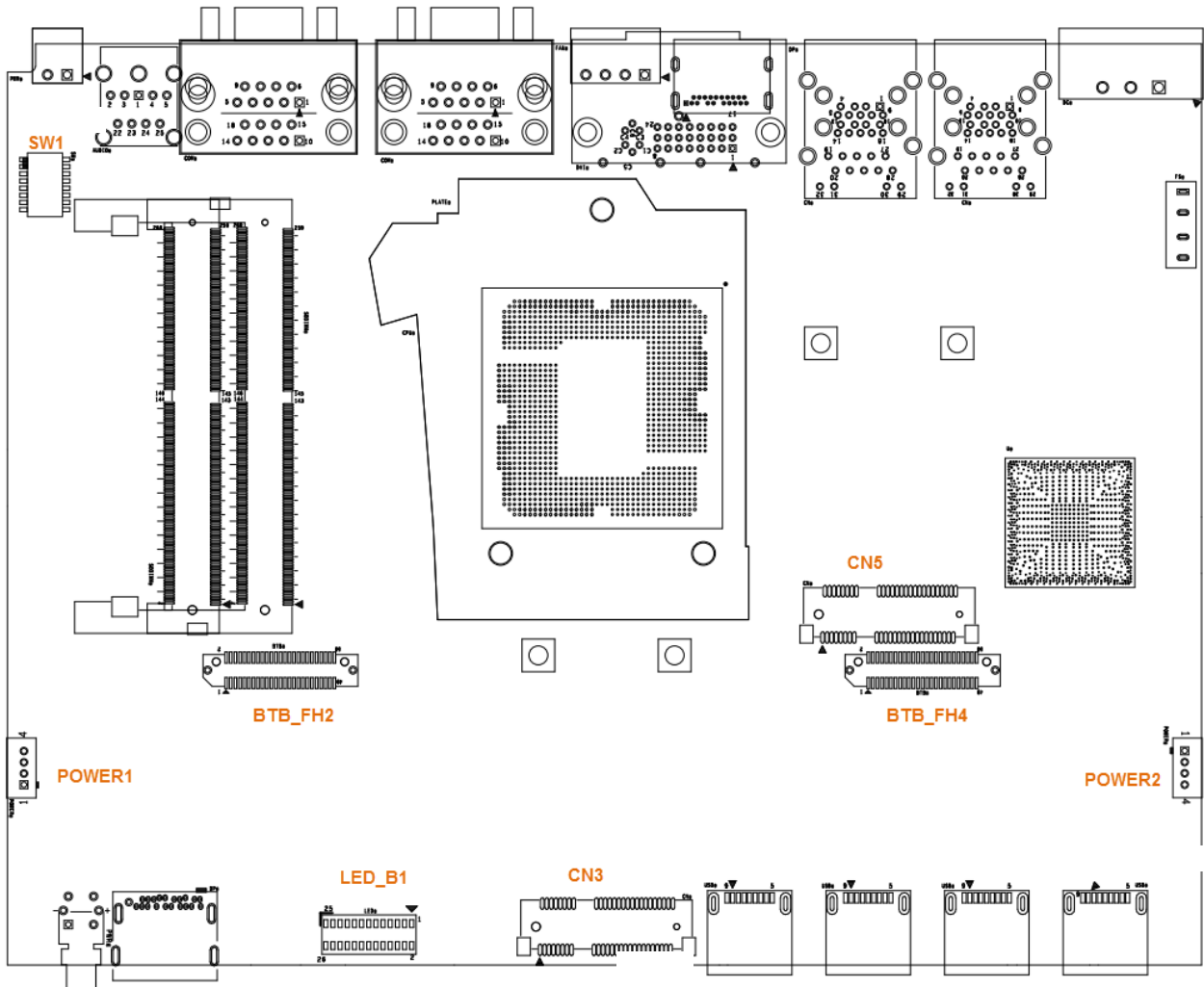

2.1.2 Bottom View

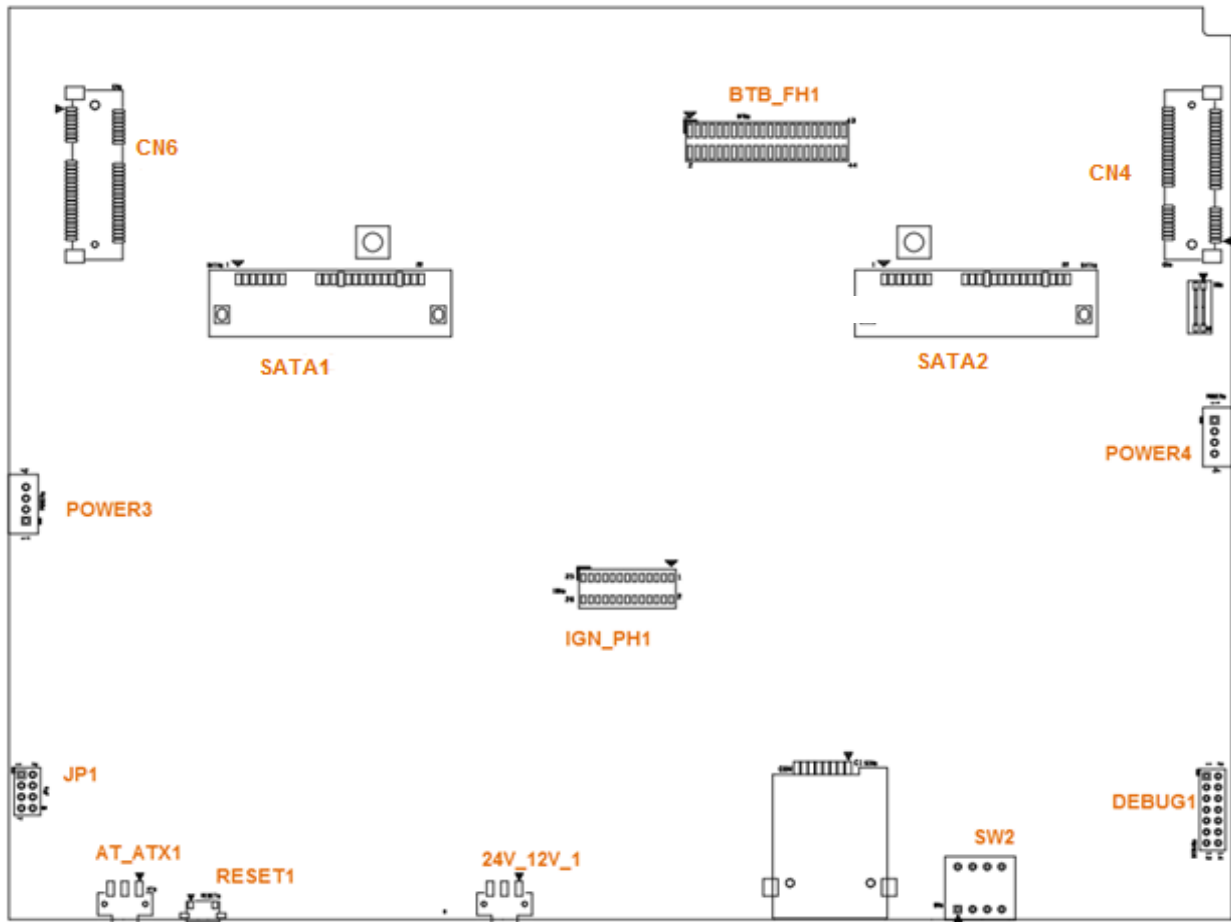

2.2 Switches and Connectors Definition

List of Switch and Connector

Location	Definition
COM1_1, COM1_2	RS232 / RS422 / RS485 Connector
CN1	LAN1 and USB3.0 Ports
CN2	LAN2 and USB3.0 Ports
CN3	Mini PCI-Express Socket + mSATA + 3G Module
CN4, 5, 6	Mini PCI-Express / mSATA Socket
DC_IN1	3-pin DC 9~48V Power Input with Power Ignition Connector
PWR_SW1	Power Button
PWR_SW2	Remote Power on/off
DP1	DisplayPort Connector
DVI_I1	DVI-I Connector
FAN1	External PWM Fan Connector
AUDIO1	Audio Jack / MIC_IN / LINE_OUT
DP2	DisplayPort Connector
LED_B1	System LED Connector
USB3_1, USB3_2	USB 3.0 Ports
USB3_3, USB3_4	USB 3.0 Ports
BTB_FH2, BTB_FH4	POE LAN Port Board to Board Connector
SATA1, SATA2	22 Pin SATA Connector
FS_1	Input Fuse 15A
IGN_PH1	IGN Board to Board Connector
BTB_FH1	DIO+COM Port Board to Board Connector
SW1	COM1~4 with Power Select
SW2	IGN Board Function Setting
SW3	Super CAP SW
Power 1~4	+5V / +12V Power Output
24V_12V_1	IGN Board Function Select
AT_ATX1	AT / ATX Power Mode Switch
CLR_CMOS1	Clear BIOS Switch
Reset1	Reset Button

2.3 Definition of Switches

SW1: COM1/COM2/COM3/COM4 Power Select

Location	Function		DIP1	DIP2
SW1	COM1	0V(RI)	ON (Default)	ON (Default)
		5V	ON	OFF
		12V	OFF	OFF



Location	Function		DIP3	DIP4
SW1	COM2	0V(RI)	ON (Default)	ON (Default)
		5V	ON	OFF
		12V	OFF	OFF

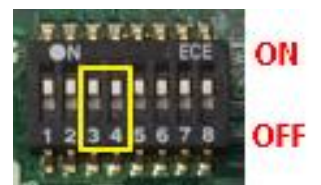

Location	Function		DIP5	DIP6
SW1	COM3	0V(RI)	ON (Default)	ON (Default)
		5V	ON	OFF
		12V	OFF	OFF

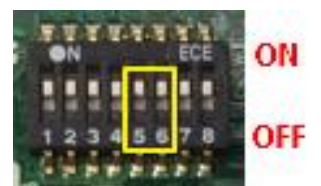

Location	Function		DIP7	DIP8
SW1	COM4	0V(RI)	ON (Default)	ON (Default)
		5V	ON	OFF
		12V	OFF	OFF

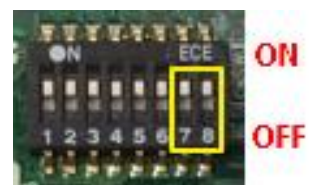

SW3: Super CAP Switch

DIP	Function	ON	OFF
1	Super CAP	Enable (Default)	Disable
2	N/A	N/A	N/A

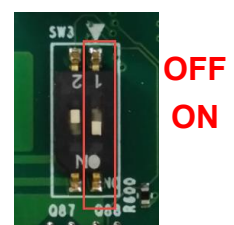

AT_ATX1: AT / ATX Power Mode Switch

Pin	Definition
1-2 (Left)	AT Power Mode
2-3 (Right)	ATX Power Mode (Default)



CLR_CMOS1: Clear CMOS Switch

Pin	Definition
1-2 (Left)	Normal (Default)
2-3 (Right)	Clear CMOS



2.4 Definition of Connectors

LED_B1: PWR / HDD / IGN / TEMP LED Status

LED B1	Status	LED Color
Power LED	Power ON	Green
	Standby	Blinking Green and Blue
HDD LED	HDD Read/Write	Blinking Yellow
TEMP LED	System Temp $\leq 65^{\circ}\text{C}$	Colorless
	$65^{\circ}\text{C} < \text{System Temp} \leq 70^{\circ}\text{C}$	Blue
	$70^{\circ}\text{C} < \text{System Temp} \leq 75^{\circ}\text{C}$	Red
	$75^{\circ}\text{C} < \text{System Temp}$	Blinking Red



Reset1: System Reset Button

Button	Definition
Push	Reset System

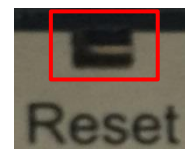

CN1 / CN2: LAN1 / 2 LED Status Definition

Act LED Status	Definition	Link LED Status	Definition
Blinking Yellow	Data Activity	Steady Green	1Gbps Network Link
Off	No Activity	Steady Orange	100Mbps Network Link
		Off	10Mbps Network Link

DC_IN1: DC Power Input Connector (+9~48V)

Connector Type: Terminal Block 1x3 3-pin, 5.0mm pitch

Pin	Definition
1	+9~48VIN
2	Ignition (IGN)
3	GND

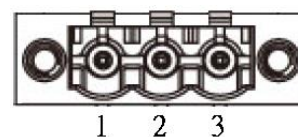

POWER1 / 2 / 3 / 4: Power Connector

Connector Type: 1x4 4-pin Wafer, 2.0mm pitch

Pin	Definition
1	+5V
2	GND
3	GND
4	+12V

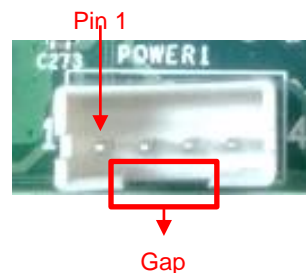

FAN1: External PWM Fan Connector

Connector Type: Terminal Block 1X4 3-pin, 3.5mm pitch

Pin	Definition
1	GND
2	+12V
3	SENSE
4	Control

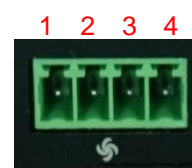

PWR_SW2: Power On/Off, SW Switch

Pin	Definition
1	GND
2	PWR_SW



(Note: Please do not apply power to the pins. This port is used to connect a switch.)

COM1 / COM2 / COM3 / COM4: RS232 / RS422 / RS485 Connector

Connector Type: 9-pin D-Sub

Pin	RS232 Definition	RS422 / 485 Full Duplex Definition	RS485 Half Duplex Definition
1	DCD	TX-	DATA -
2	RXD	TX+	DATA +
3	TXD	RX+	
4	DTR	RX-	
5	GND		
6	DSR		
7	RTS		
8	CTS		
9	RI		

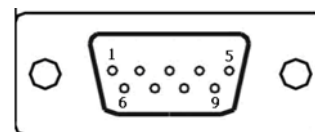

CN3 : Mini PCI-Express Socket (Support mSATA and SIM Card to Link feature)

Pin	Definition	Pin	Definition	Pin	Definition
1	WAKE#	19	NA	37	RESERVED
2	3.3V	20	3.3V	38	USB_D+
3	NA	21	GND	39	RESERVED
4	GND	22	PERST#	40	GND
5	NA	23	PERN0 / SATARP0	41	3.3V
6	1.5V	24	3.3V	42	NA
7	CLKREQ#	25	PERP0 / SATARN0	43	GND
8	RESERVED	26	GND	44	NA
9	GND	27	GND	45	CLINK_CLK
10	SIM_DATA	28	+1.5V	46	NA
11	REFCLK-	29	GND	47	CLINK_DATA
12	SIM_CLK	30	SMB_CLK	48	+1.5V
13	REFCLK+	31	PETN0 / SATATN0	49	CLINK_RST
14	SIM_Reset	32	SMB_DATA	50	GND
15	GND	33	PETP0 / SATATP0	51	NA
16	SIM_VPP	34	GND	52	+3.3V
17	NA	35	GND		
18	GND	36	USB_D-		

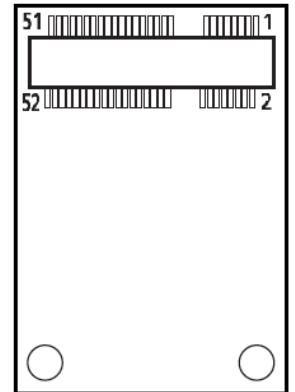

CN4 / CN5 / CN6: Mini PCI-Express Socket (Support mSATA feature)

Pin	Definition	Pin	Definition	Pin	Definition
1	WAKE#	19	NA	37	GND
2	3.3V	20	3.3V	38	USB_D+
3	NA	21	GND	39	3.3V
4	GND	22	PERST#	40	GND
5	NA	23	PERN0 / SATARPO	41	3.3V
6	1.5V	24	+3.3VAUX	42	NA
7	CLKREQ#	25	PERP0 / SATARN0	43	GND
8	NA	26	GND	44	NA
9	GND	27	GND	45	NA
10	NA	28	+1.5V	46	NA
11	REFCLK-	29	GND	47	NA
12	NA	30	SMB_CLK	48	+1.5V
13	REFCLK+	31	PETN0 / ATATN0	49	NA
14	NA	32	SMB_DATA	50	GND
15	GND	33	PETP0 / SATATP0	51	NA
16	NA	34	GND	52	+3.3V
17	NA	35	GND		
18	GND	36	USB_D-		

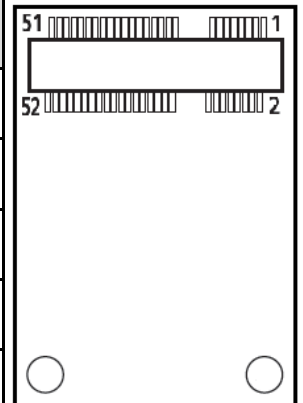



Chapter 3

System Setup

3.1 Removing the Top Cover



WARNING

In order to prevent electric shock or system damage, before removing the chassis cover, must turn off power and disconnect the unit from power source.

1. Turn over the unit to have the bottom side face up, loosen the 6 screws on the bottom cover and place them aside for later use.

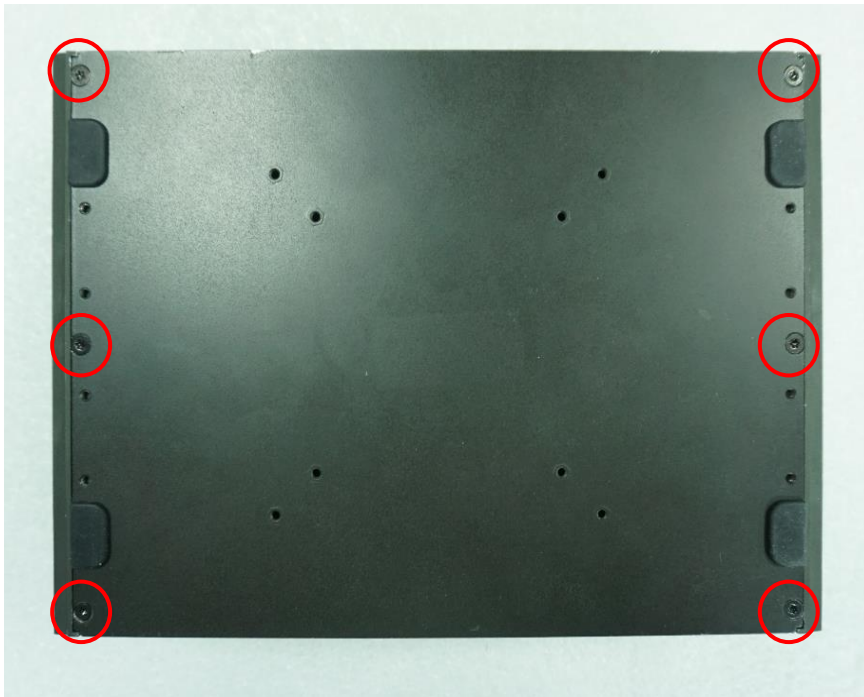

2. Remove the bottom cover from the chassis.



3. Loosen the 4 screws. Pull out 4 latches as marked on photo.

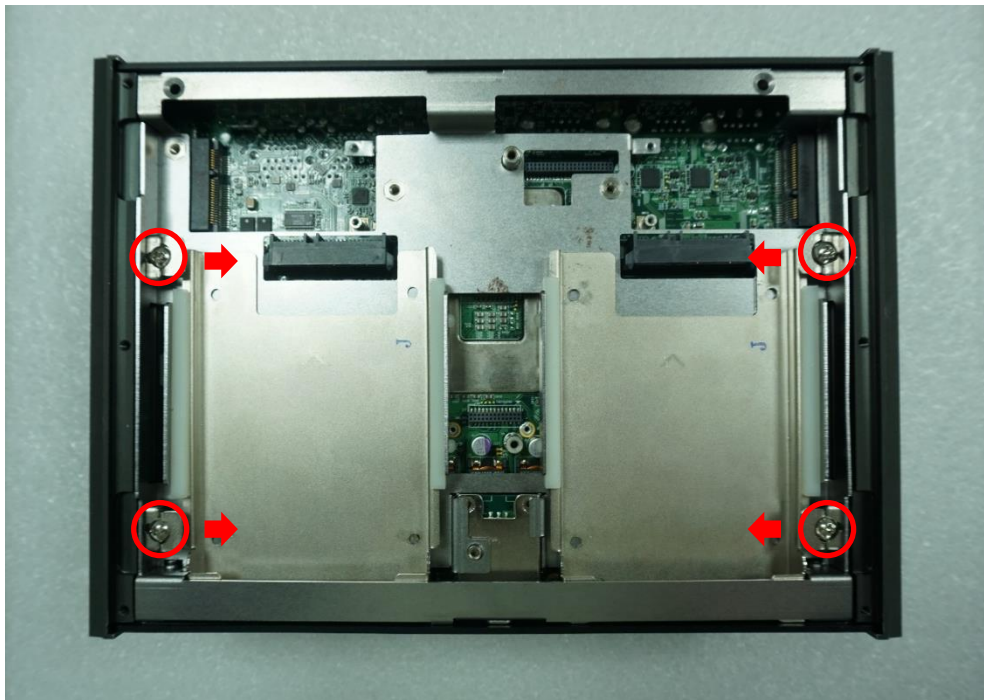

4. Hold front and rear panel and lift up the body of unit vertically.

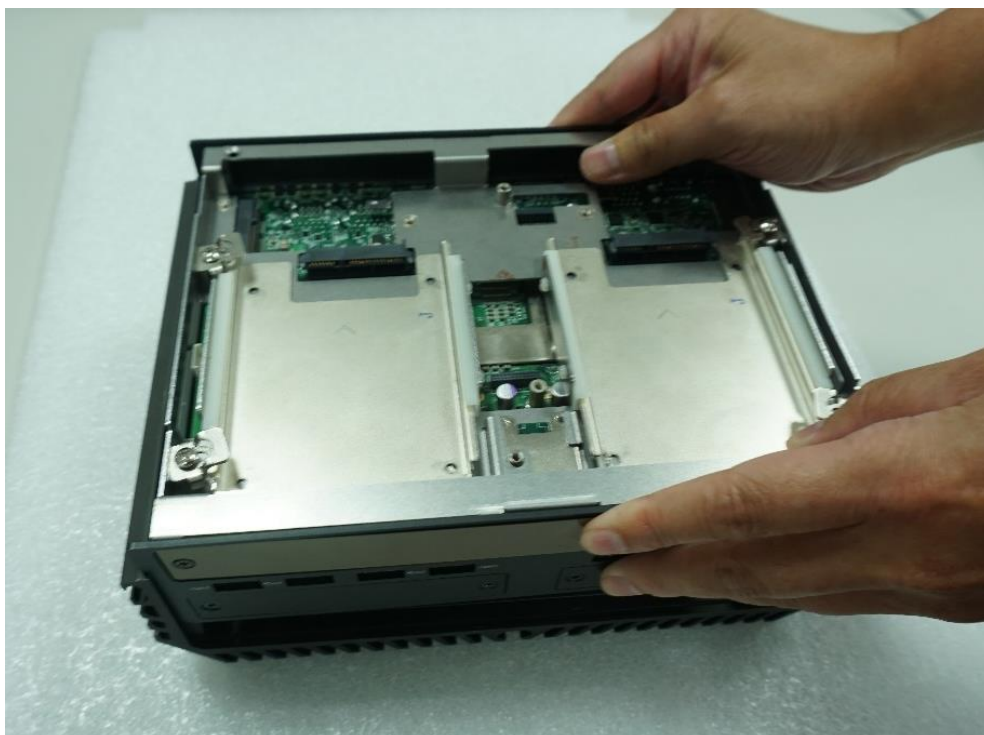

5. Turn over the body of the unit and place it gently.

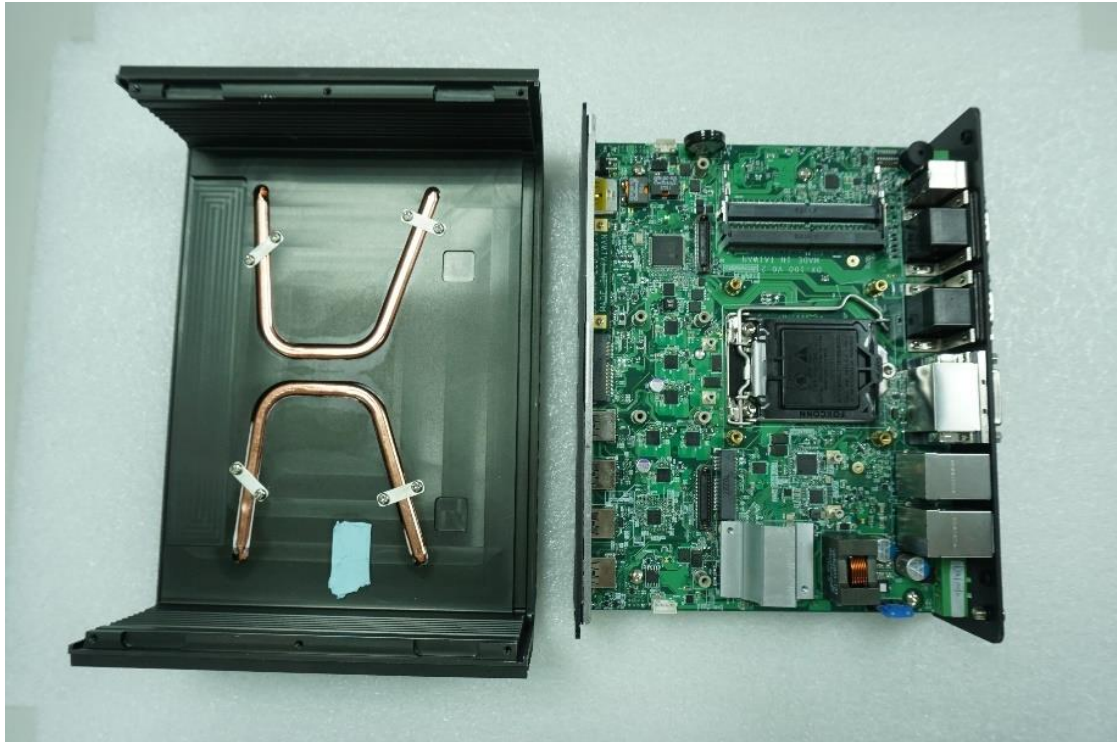

3.2 Installing the CPU

1. Locate the CPU socket, remove the protection cover on it.

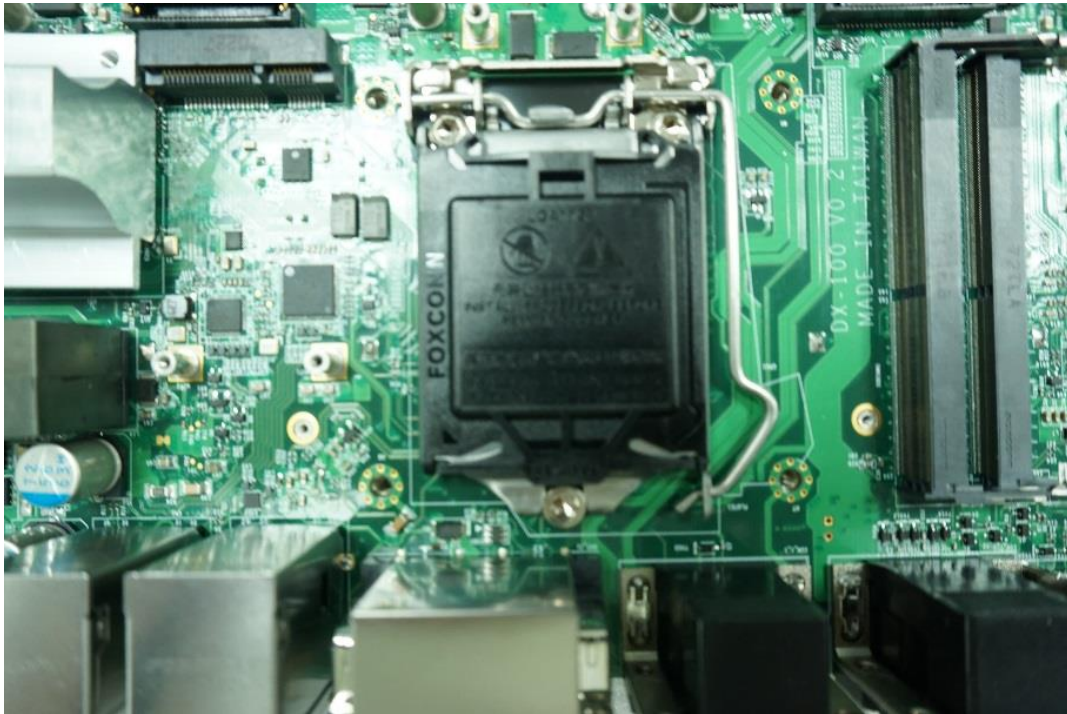

2. Press the CPU socket lever and pull it aside away from the socket to unlock it. Pull back the lever to open the socket.



- Align the notches on CPU with the alignment post on socket.



- The notches of socket provide the space for fingers while lowering the CPU, hold the CPU by the edges toward the notches and insert the CPU gently.



- Place the thermal pad on the CPU heat spreader. Press down the socket lever to lock the CPU.

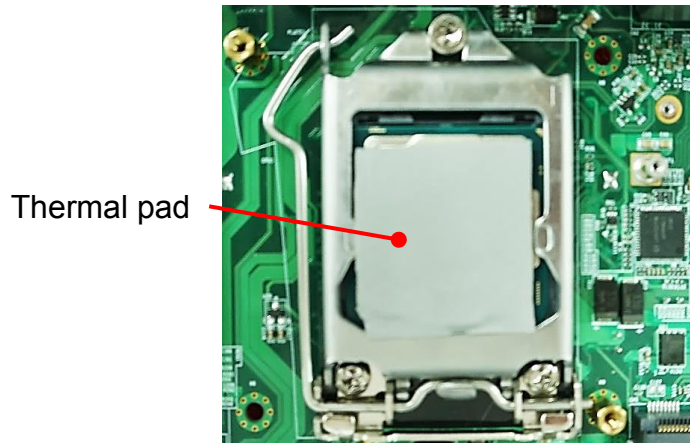

Note: Before putting on the thermal block (in the next step), please make sure the protective film on the Thermal Pad has been removed!

- Confirm the installation direction of the CPU heatsink and align mounting holes of heatsink with the four nut studs.

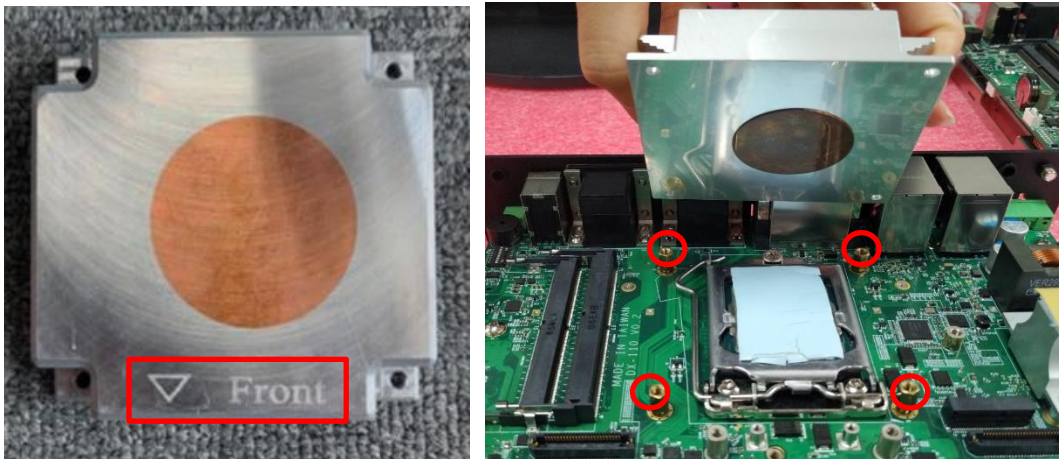

- Flip the corner of thermal pad and fasten the heat sink with provided 4 screws.

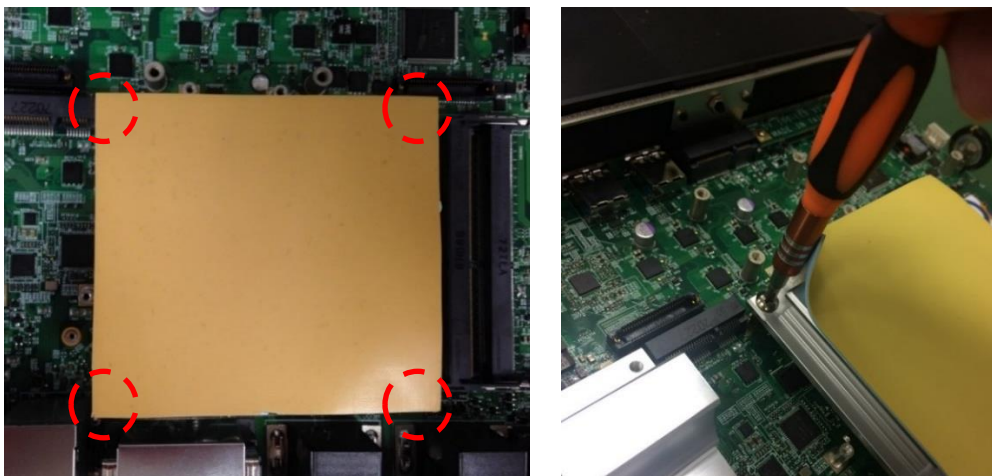

Note: Before assembling the system's chassis cover, please make sure the protective film on the Thermal Pad has been removed!

3.3 Installing SO-DIMM Memory

1. Locate the SODIMM socket on the top side of system.

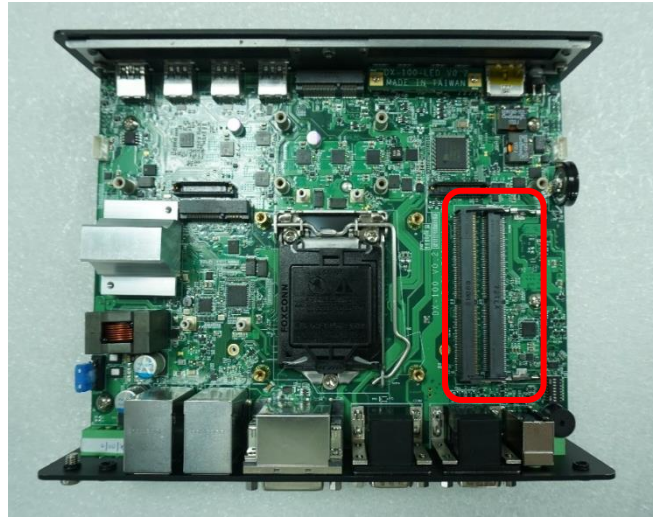

2. Insert a SO-DIMM at a 45-degree angle until its edge connector is connected to SO-DIMM socket firmly.



Lower socket

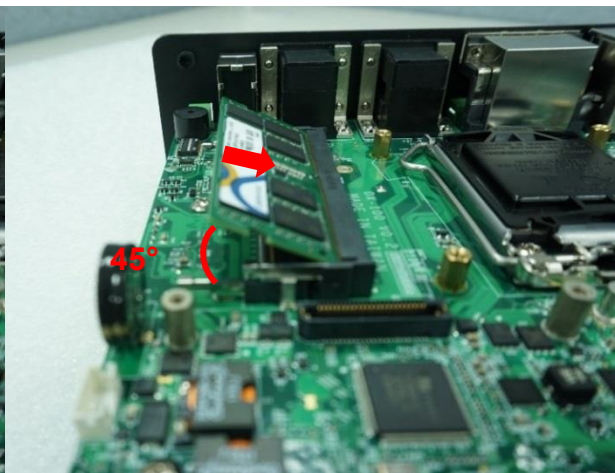

Upper socket

3. Press down the module until the retaining clips snap back in place.



Lower socket



Upper socket

3.4 Installing a Mini-PCle/mSATA Card

1. Locate the Mini PCIe socket on the top side of system.

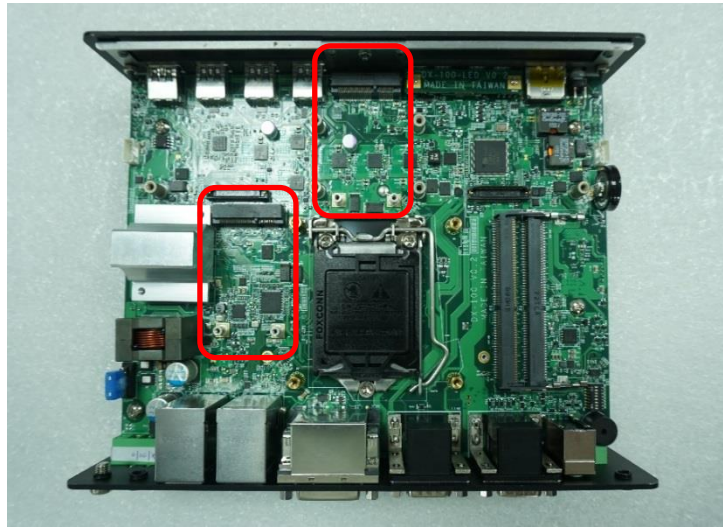

2. Insert the Mini-PCle card at a 45-degree angle until its edge connector is connected firmly into slot. For 3G/4G Mini-PCle card, please install on CN3 slot.

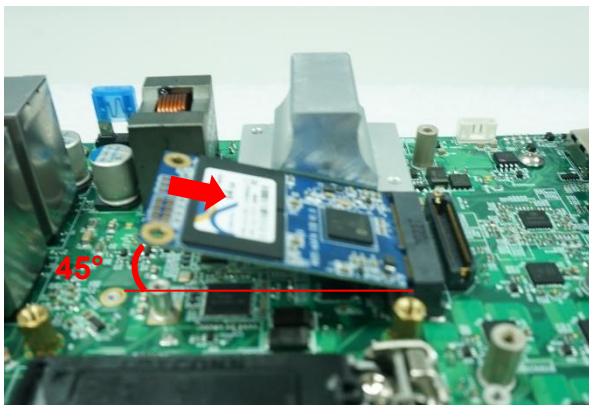

CN3,4,5,6 slot

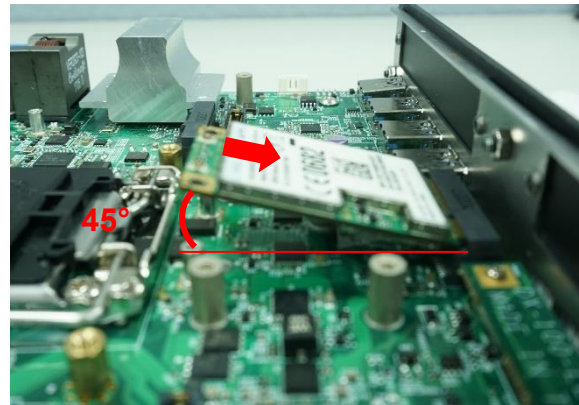

CN3 slot

3. Press the card down and secure it with 2 screws.



3.5 Installing Antennas

1. Remove the antenna rubber covers on rear panel.



2. Penetrate the antenna jack through the hole at both sides as illustrated.

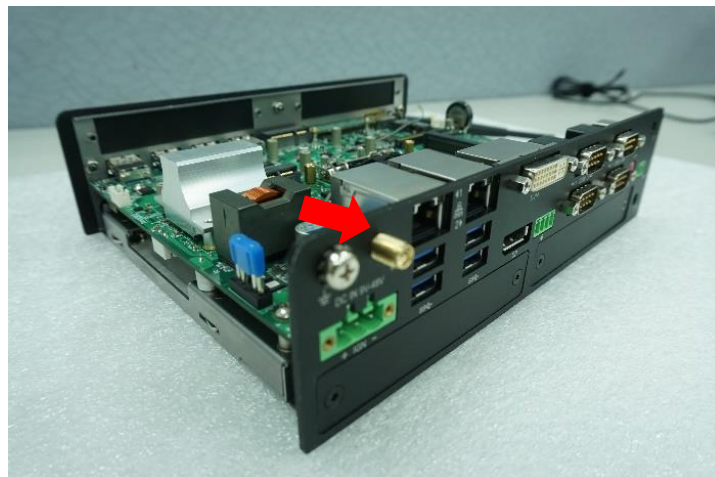

3. Put on washer and fasten the nut with antenna jack.



4. Assemble the antenna and antenna jack together.

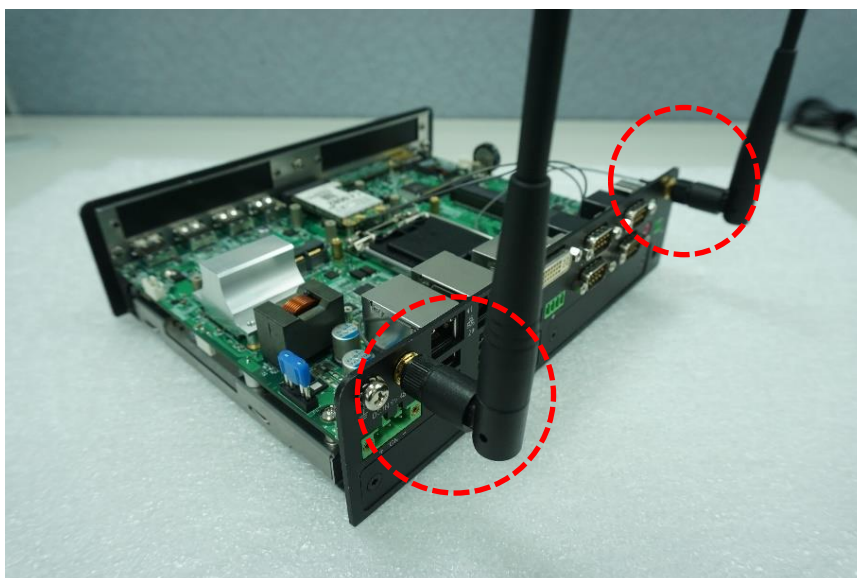

5. Attach the RF connector at another end of cable onto the module.

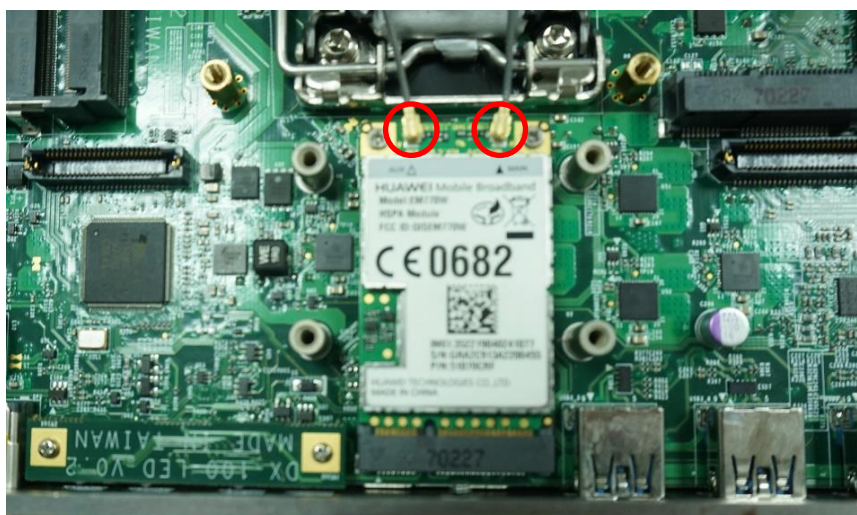

3.6 Installing a CFM-IGN Power Ignition Module

1. Locate the IGN connector on the bottom side of system.

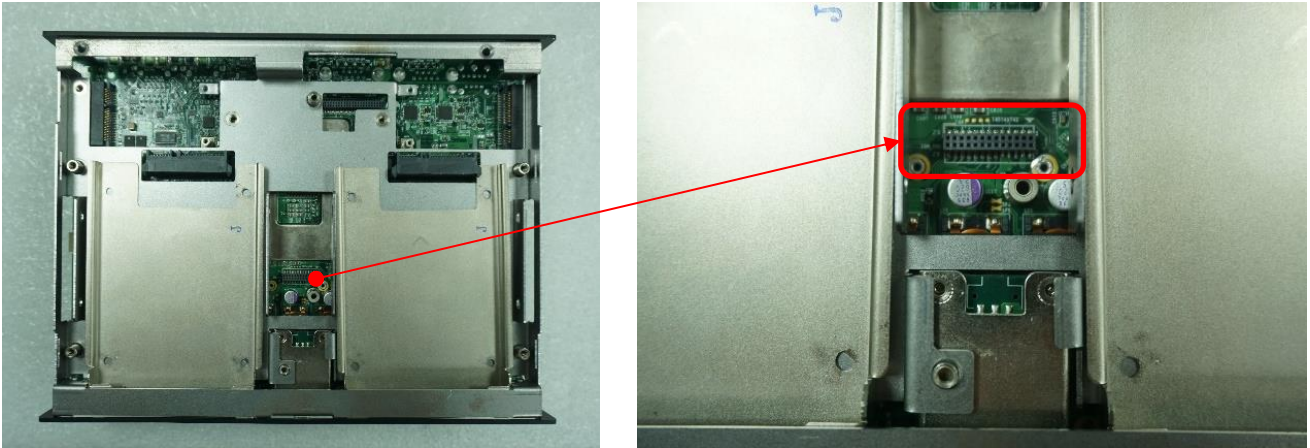

2. Fasten 1 copper pillar before insert IGN module.



3. Insert IGN module vertically to the female connector on the system's mainboard, and fasten 2 screws to fix it.

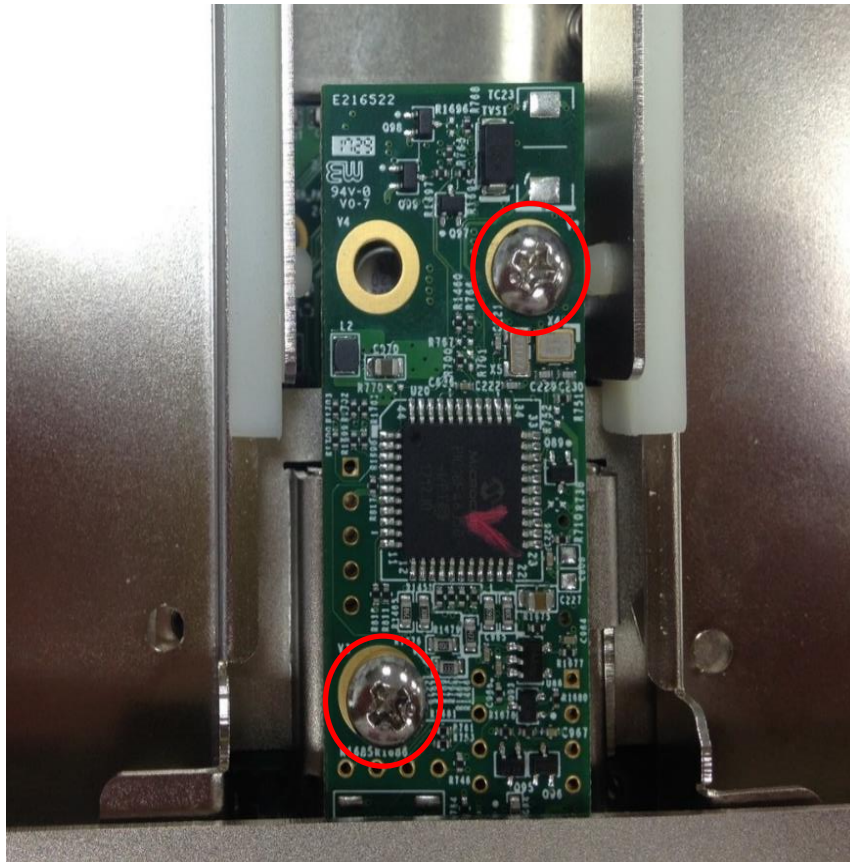

3.7 Installing a CMI-COM Module

1. Locate the connector of CMI-module on the bottom side of system.

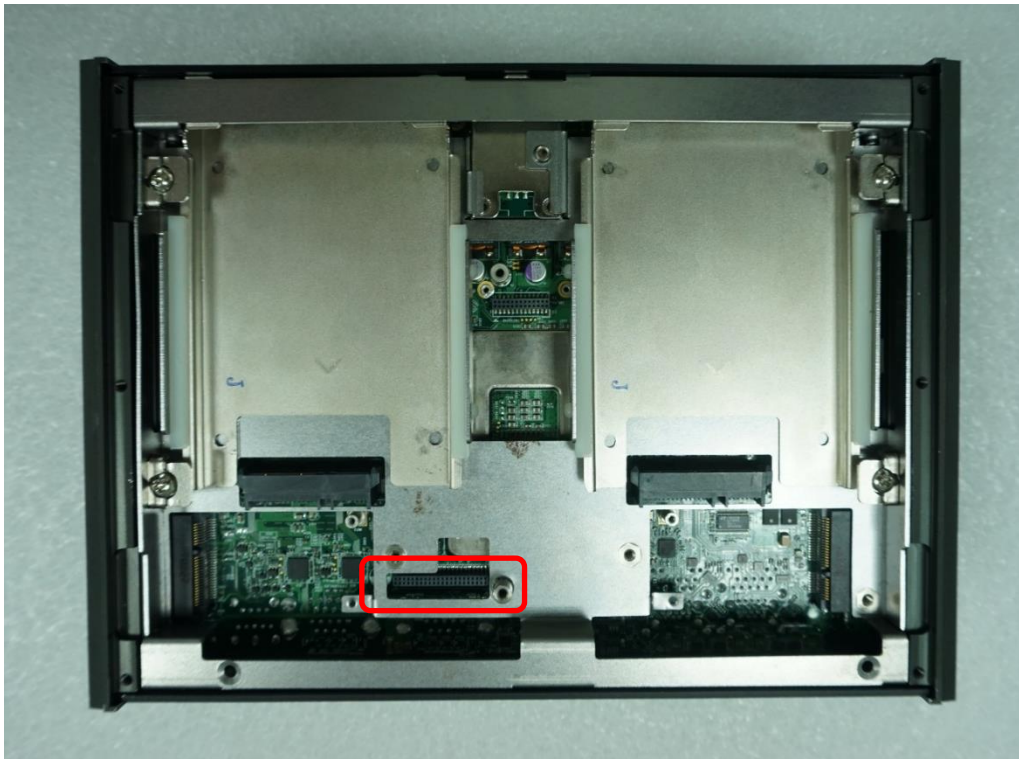

2. Loosen the 2 screws on rear bezel to remove the cover plate.



3. Insert the CMI-COM module carefully into the CMI connector on main board. Fix it with 2 screws.



4. Loosen the 4 D-Sub jack screws as marked on photo.

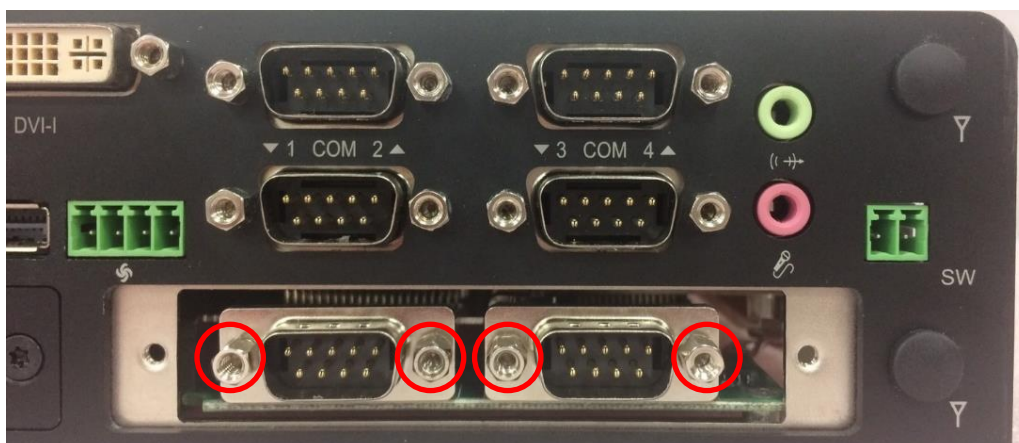

5. Attach the COM bracket. Fasten 2 screws and 4 D-Sub jack screws to fix it..



3.8 Installing a CMI-DIO Module

1. Locate the connector of CMI-DIO module on the bottom side of system.

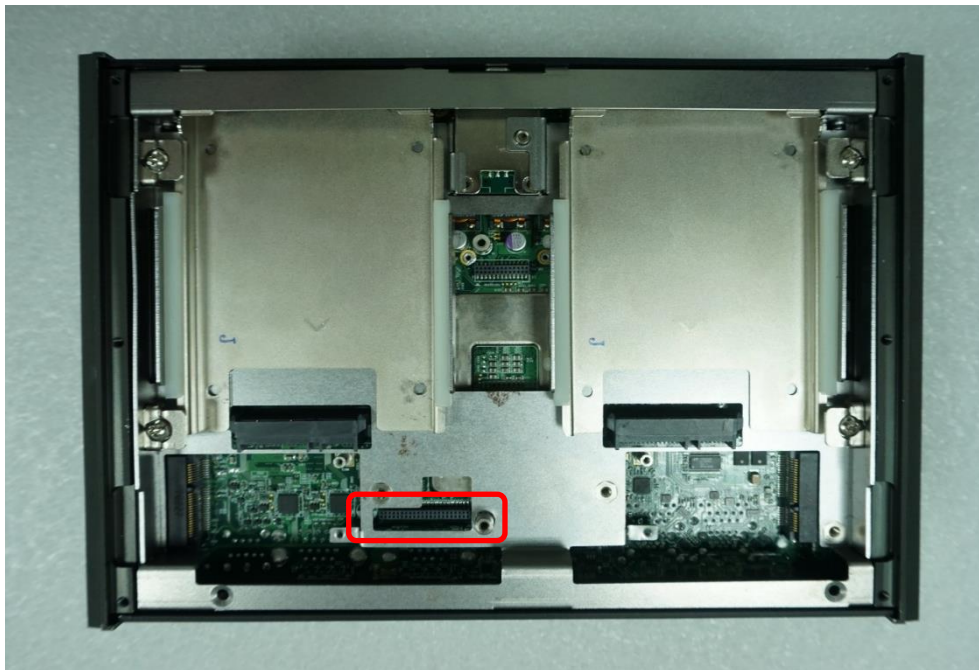

2. Loosen the 2 screws on rear bezel to remove the cover plate.

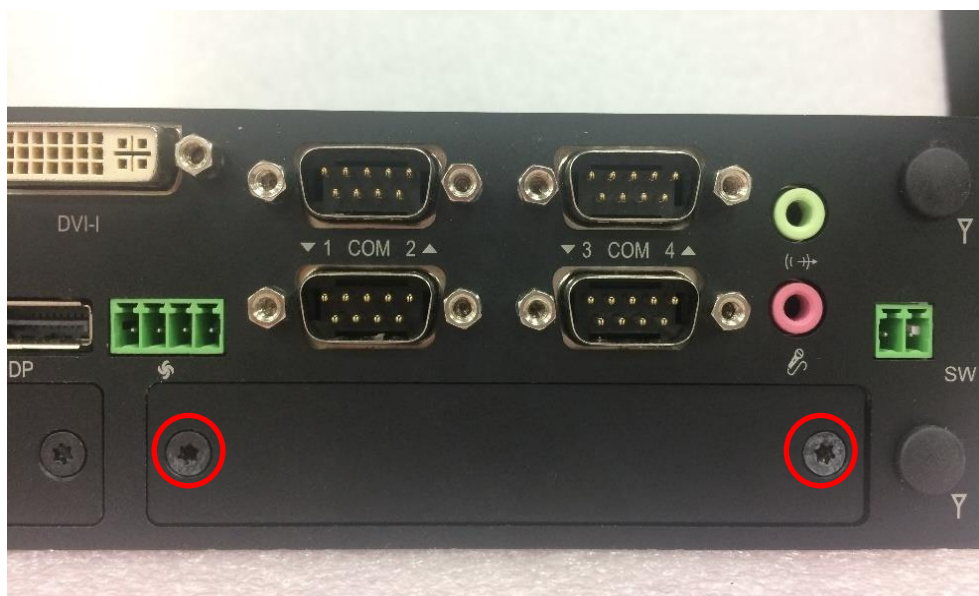

3. Insert the CMI-DIO module carefully into the CMI connector on main board. Fix it with 2 screws.

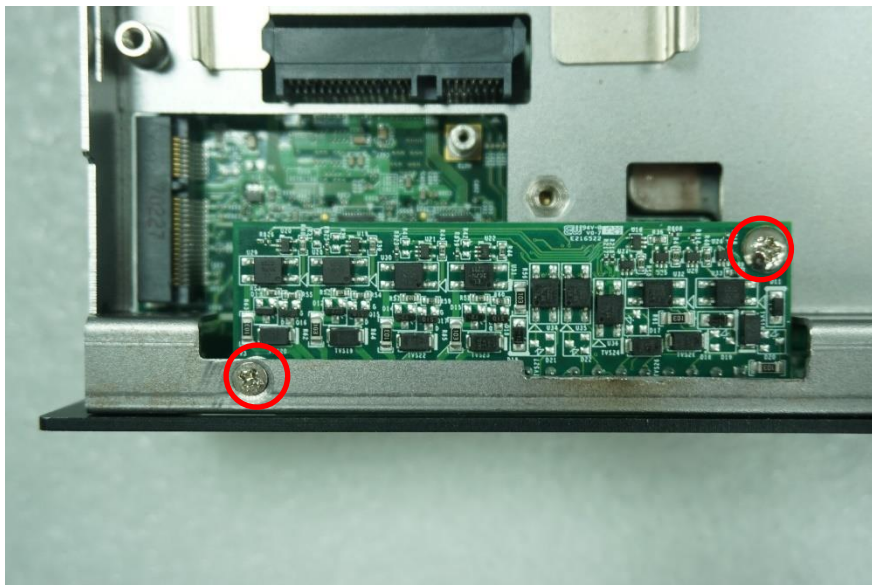

4. Attach the DIO bracket, and fasten 2 screws to fix it.



3.9 Installing CMI-M12LAN Module

Note: The photo example in this section is illustrated by CMI-M12LAN01-R12/UB0910 module as shown in below picture.

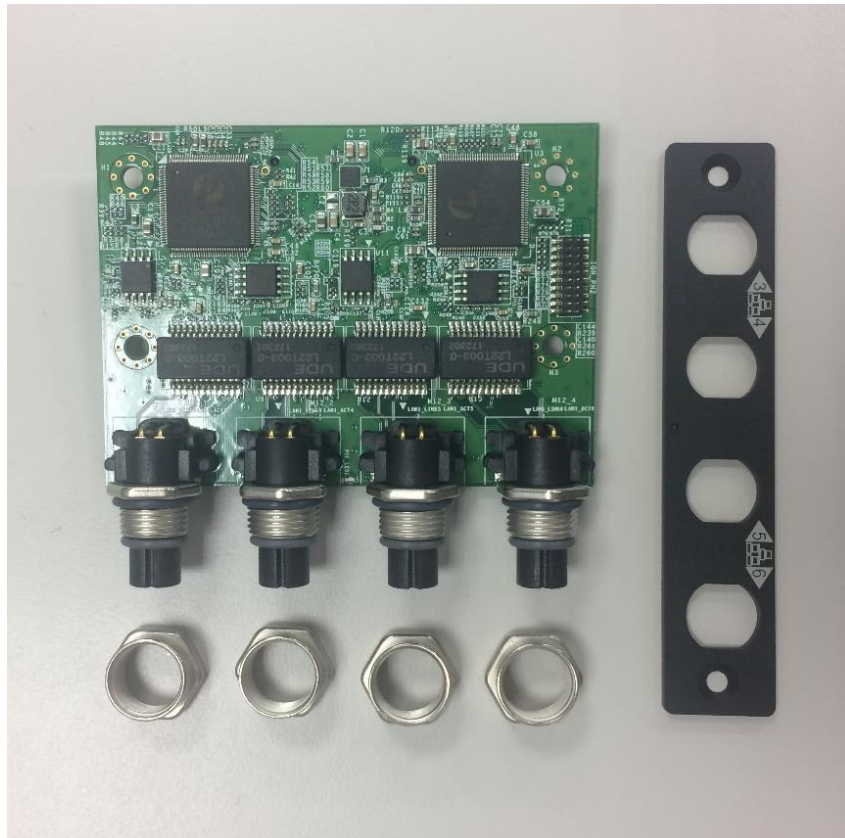

1. Loosen the 2 screws on front bezel to remove the cover plate.

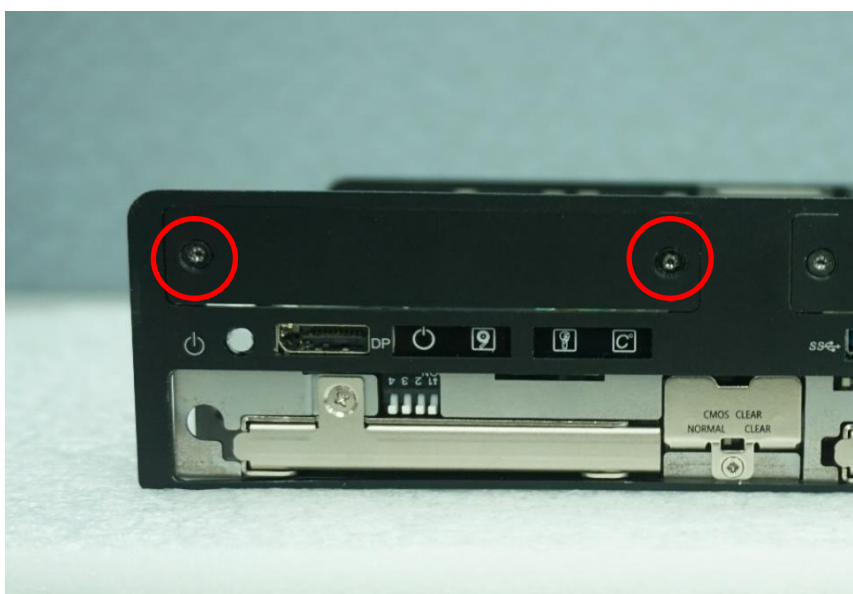

2. Remove 4 rubber rings on M12 jacks; Penetrate M12 jacks of CMI module through the accompanying M12 I/O bracket. then fasten 4 ring hexes onto jacks as illustrated in right hand picture below.

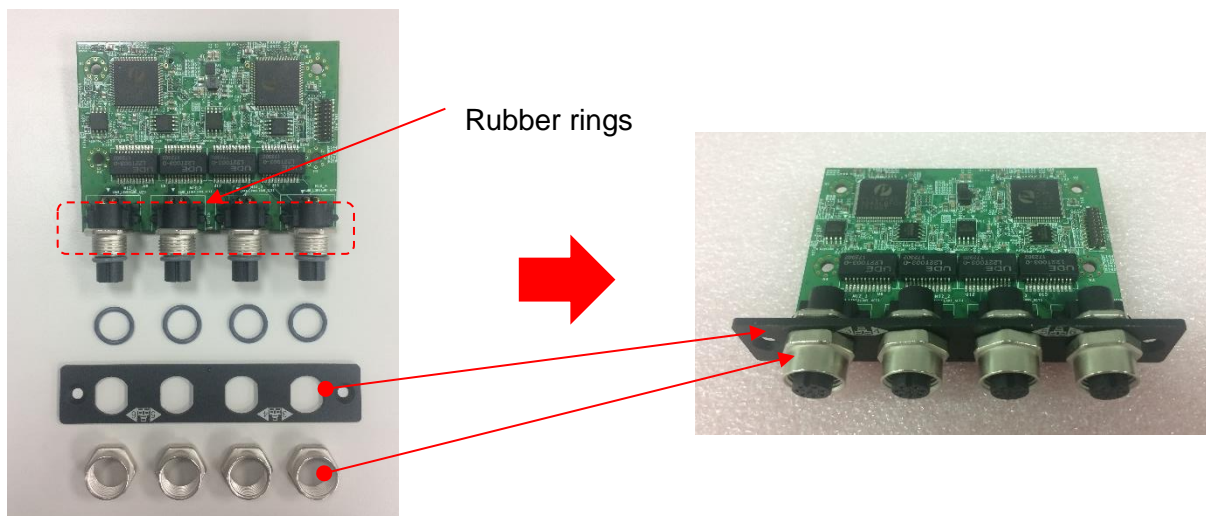

3. Locate the CMI connector on the top side of system.

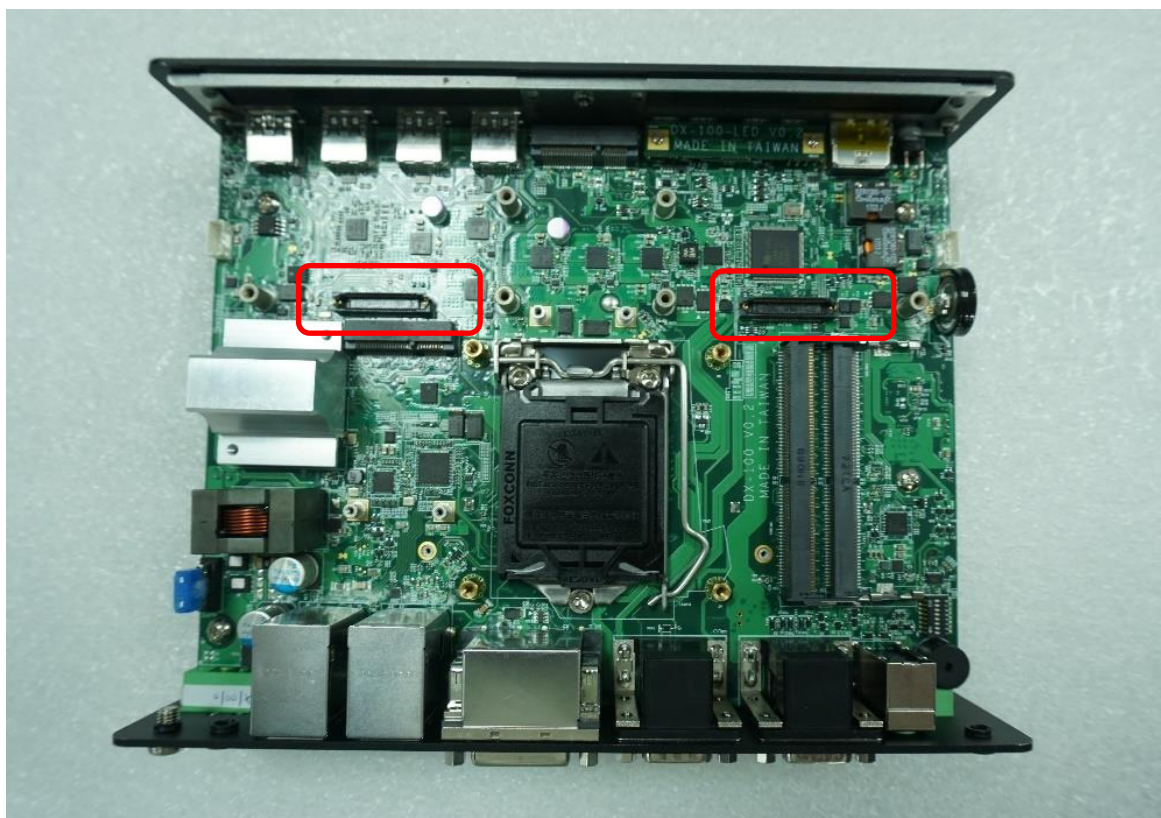

4. Exchange screw to copper pillar before insert the CMI module.

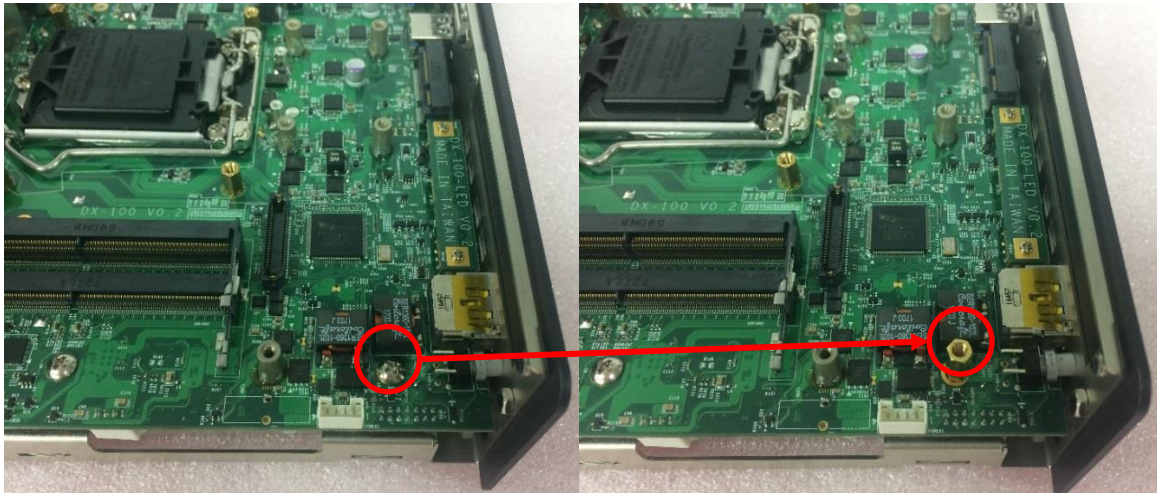

5. Insert the CMI module vertically into the female connector on system's mainboard until it's connected firmly and fasten 4 screws to fix it.

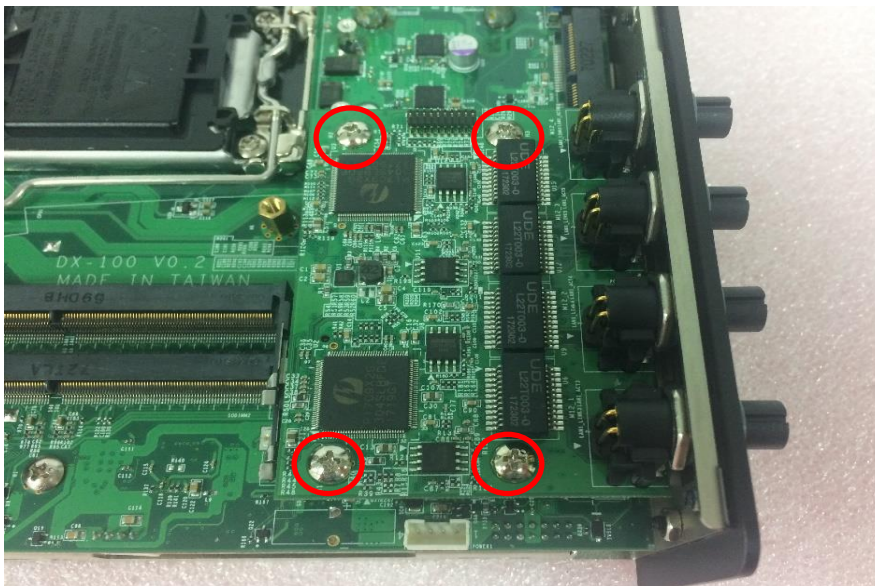

6. Fasten 2 screws on cover plate.



3.10 Installing a CFM-PoE Module

1. If you use CMI-RJ45LAN Module (CMI-LAN01-R12/UB0912), please paste the shading tape to the place which was marked by red circle. If you use CMI-M12LAN Module please skip this step. (Note: Please don't block the LED.)

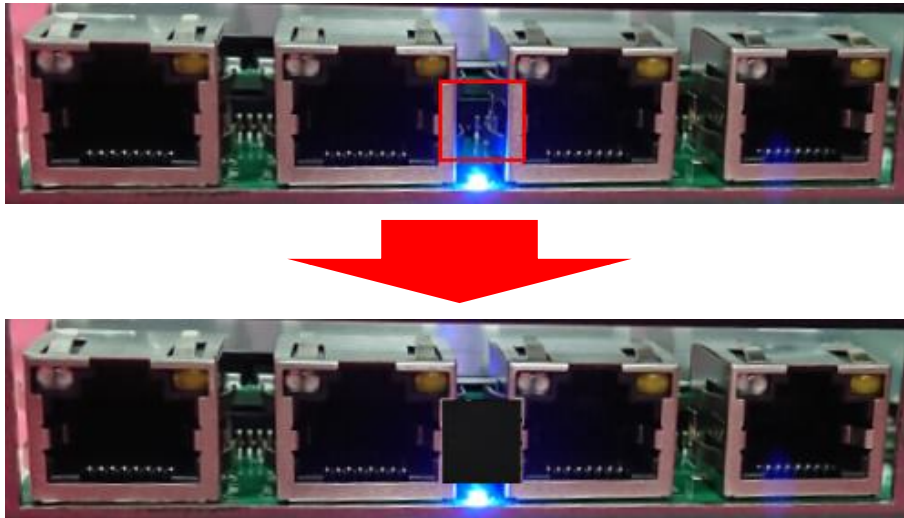

2. Insert the CMI-M12 module vertically into the female connector on system's mainboard until it's connected firmly, and fasten 4 copper pillars to fix it.

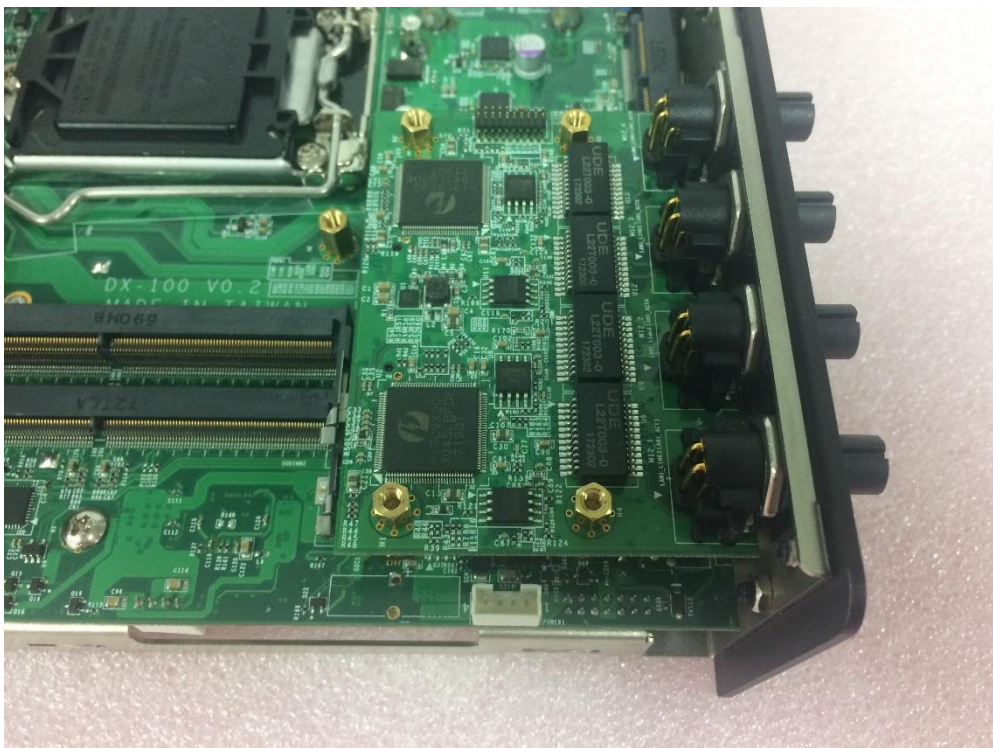

3. Turn over the heatsink and locate the two places which were marked by red circles.

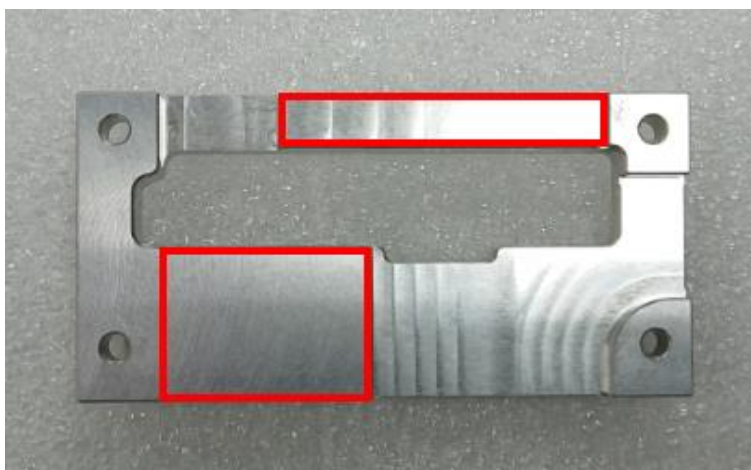

4. Please paste the 2 thermal pads onto the heatsink carefully.

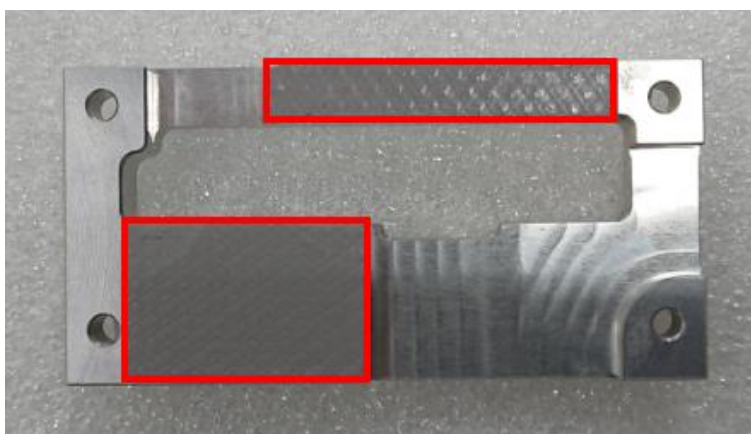

Note: Before putting on the thermal block (in the next step), please make sure the protective film on the Thermal Pad has been removed!

5. Please paste the heatsink onto the CMI-PoE module carefully and connect the PoE module to the CMI-M12 module.



6. Fasten 4 screws to fix it.

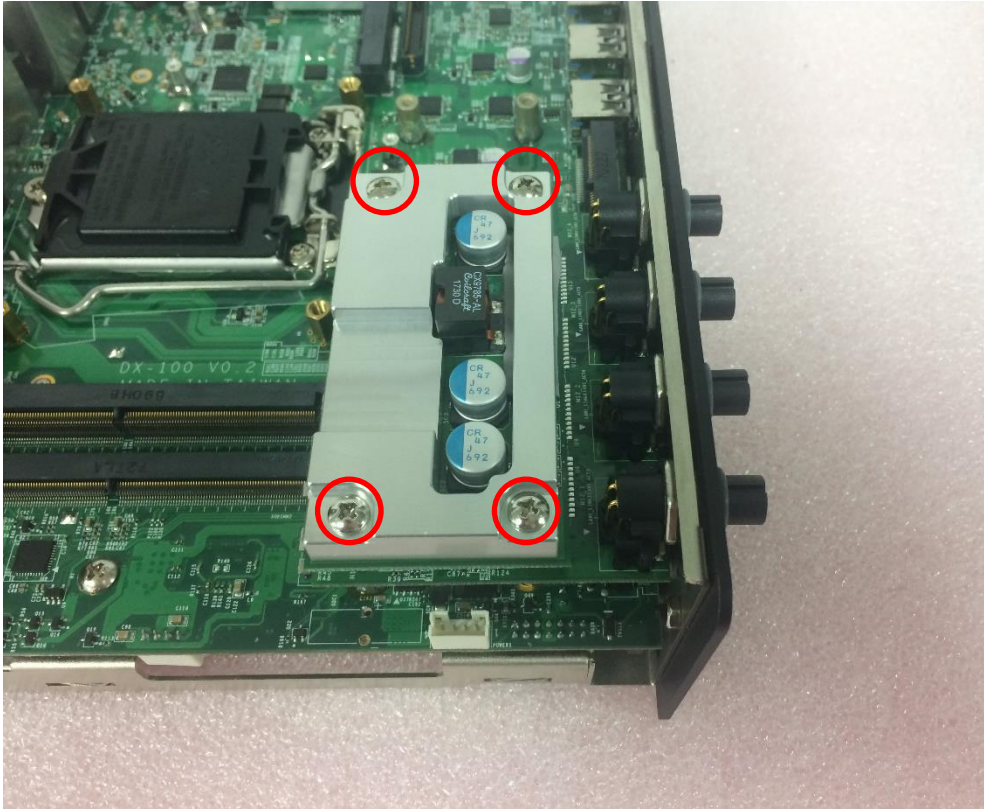

7. Please paste the thermal pad onto the heatsink carefully.

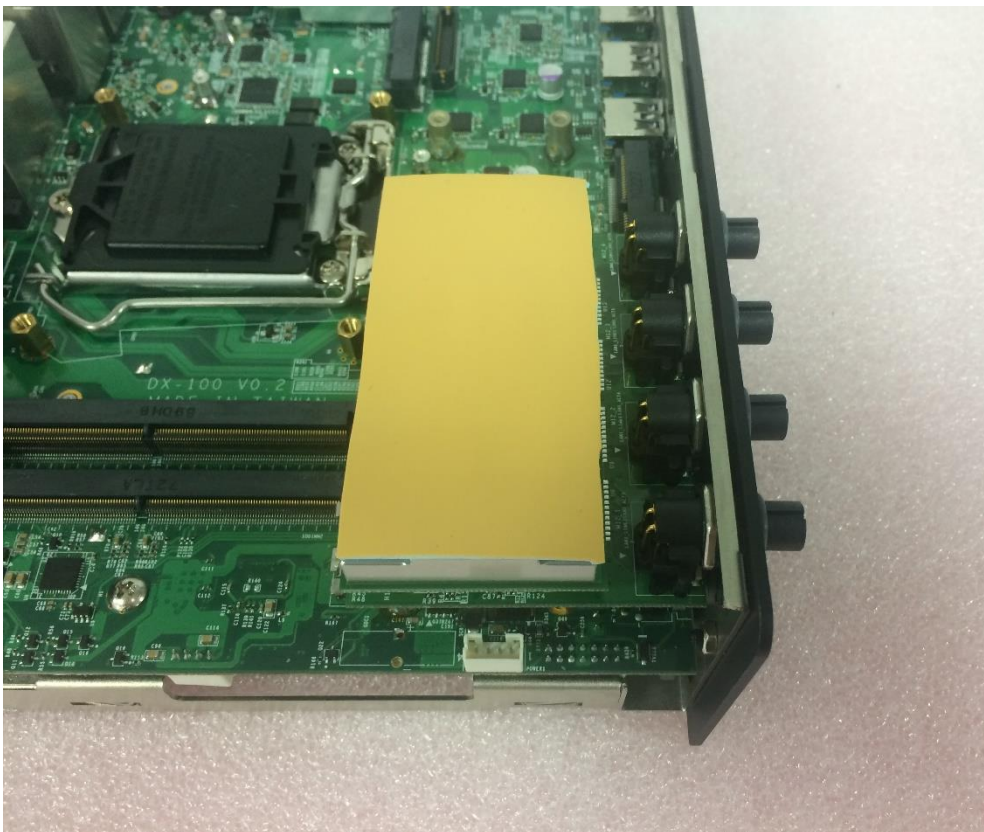

Note: Before assembling the system's chassis cover, please make sure the protective film on the Thermal Pad has been removed!

3.11 Installing Thermal Pad

Note: The DX-1000 series don't need to additional installation of the PCH thermal pad.

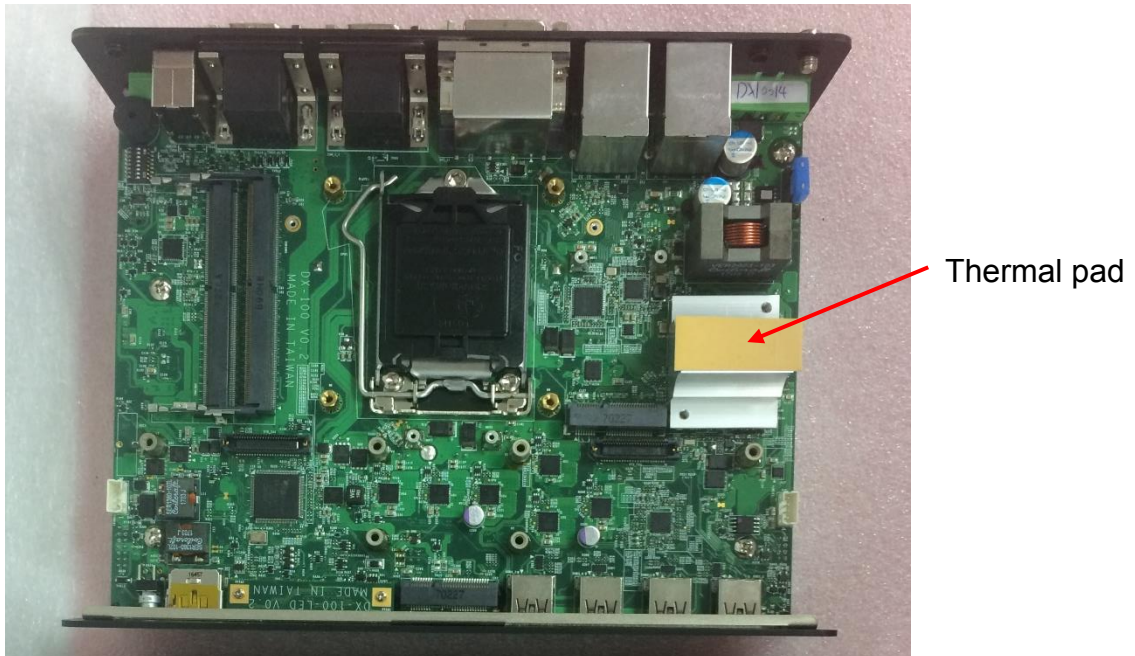

Note: Before assembling the system's chassis cover, please make sure the protective film on the Thermal Pad has been removed!

3.12 Installing Top Cover

1. Hold front and rear panel and put the body of unit back to chassis and fasten the 4 screws as marked on photo.

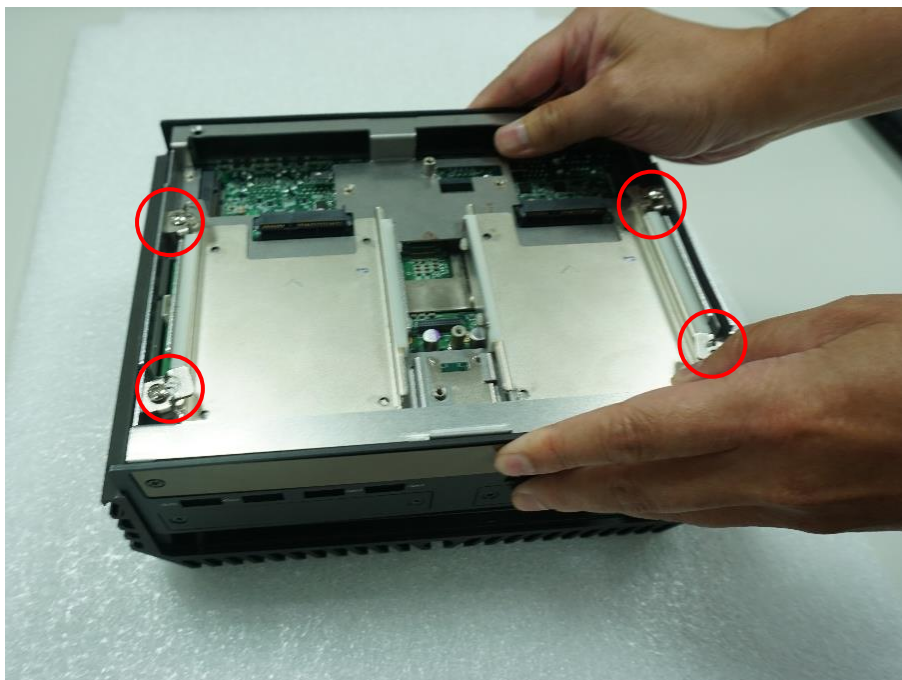

3.13 Installing Bottom Cover

1. Place the bottom cover back to system.



2. Fasten the bottom cover with 6 screws.

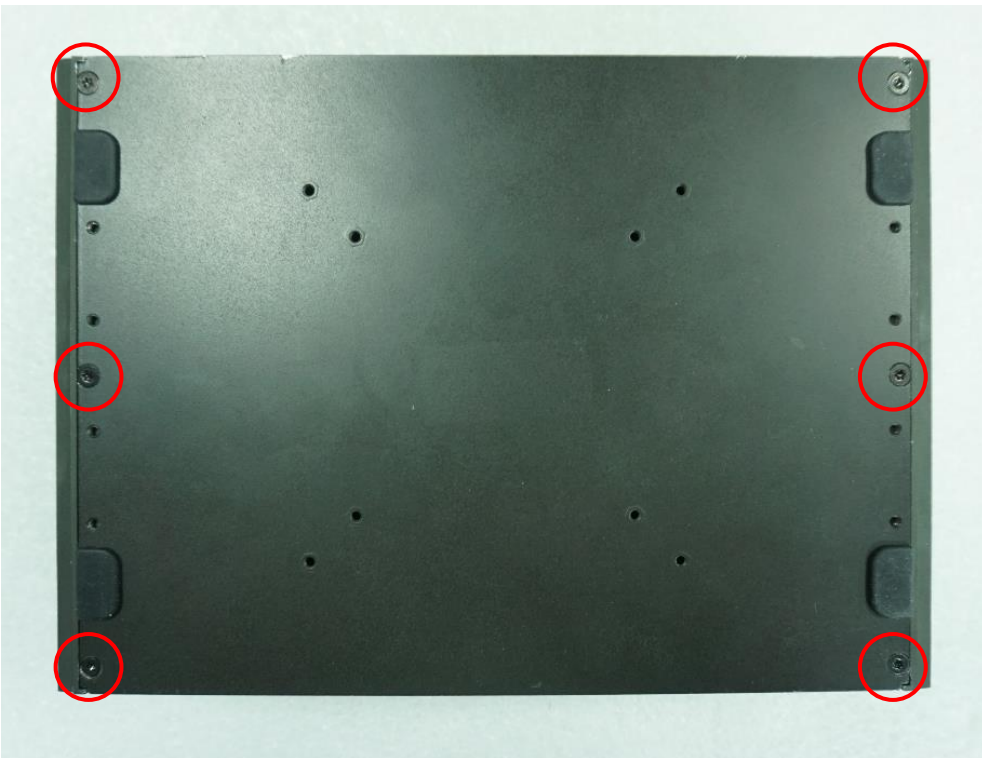

3.14 Removing the Front Cover Plate

1. Loosen 2 screws on front panel to remove cover plate.

Note: It's advised to fasten the 2 screws manually. If fastened with an electrical screw driver, please set the torque of the driver to 2.5KgF.



3.15 Installing a SATA Hard Drive at Front Side

1. Locate the removable HDD bay and loosen the screw.

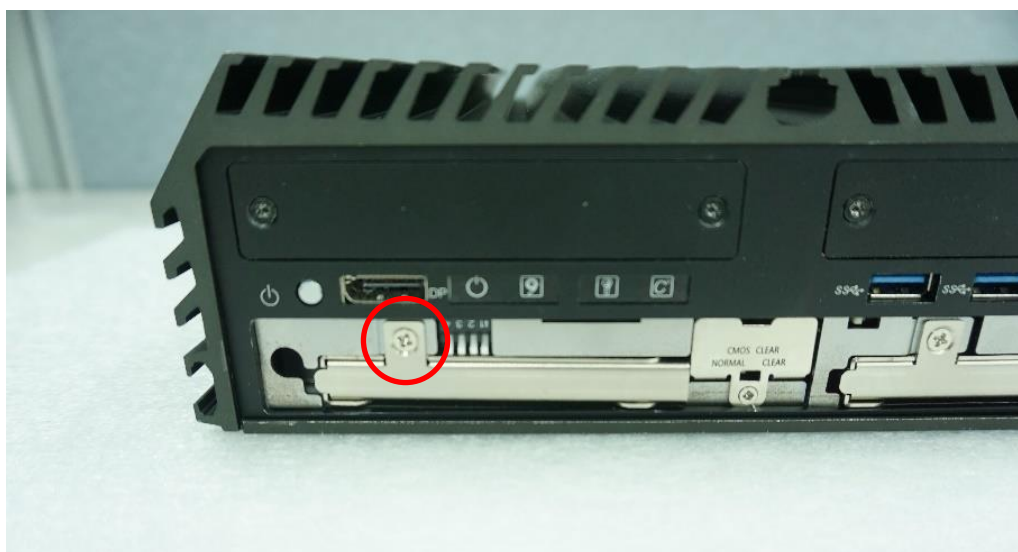

2. Pull the rotating arm and pull the HDD bracket out of system.

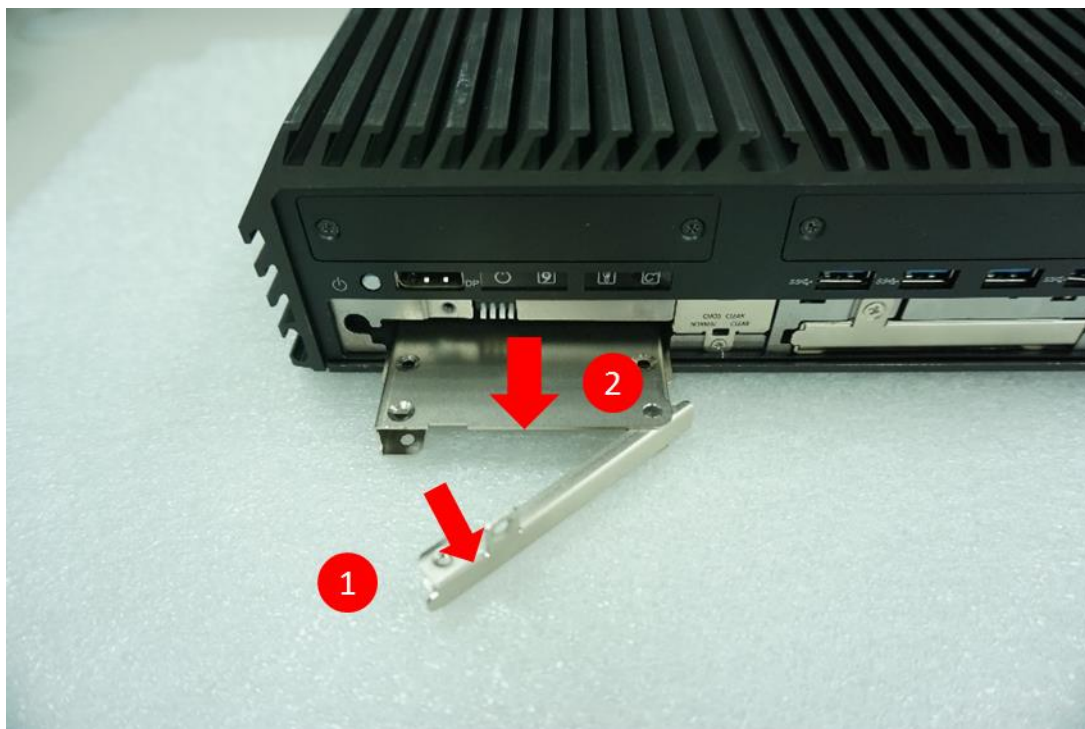

3. Make the bottom side of the HDD face up, place the HDD bracket on it. Ensure the direction of bracket is correct and use 4 provided screws to assemble HDD and HDD bracket together.

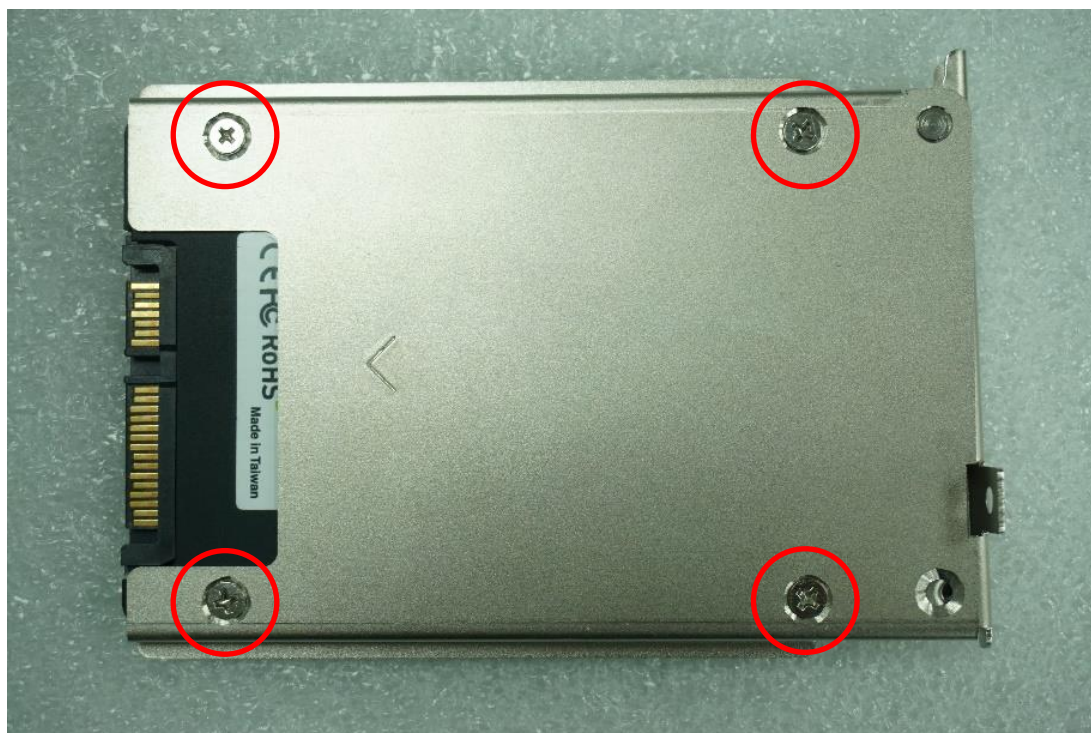

4. Align the HDD bracket assembly with the entrance of removable HDD bay. Holding the rotating arm and insert the HDD bracket until the connector of HDD contact the SATA connector firmly.



5. Place the rotating arm back and fasten the screw.

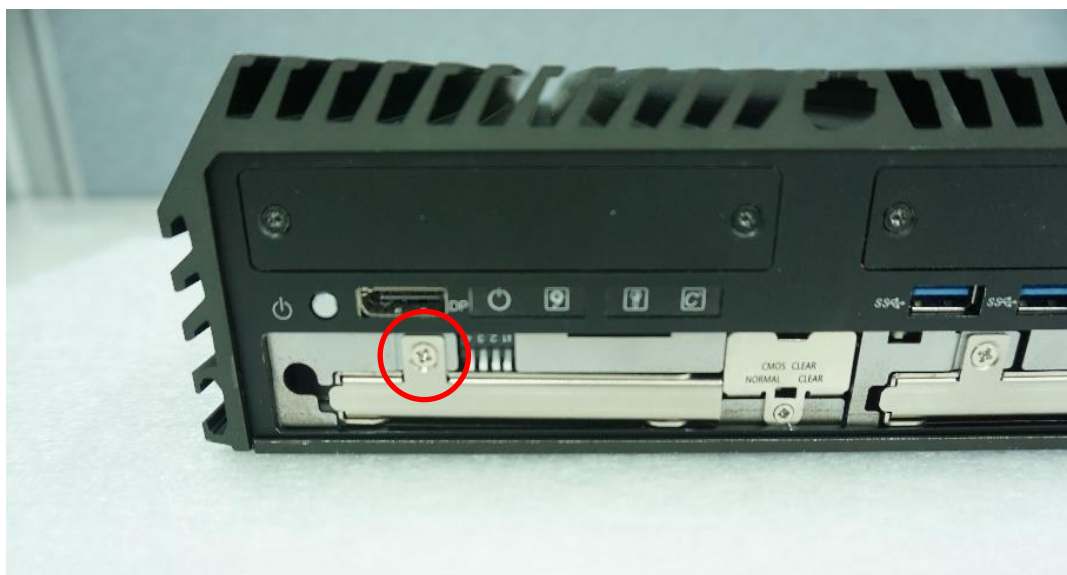

3.16 Installing a SIM Card

1. Locate the SIM card slot at front side.

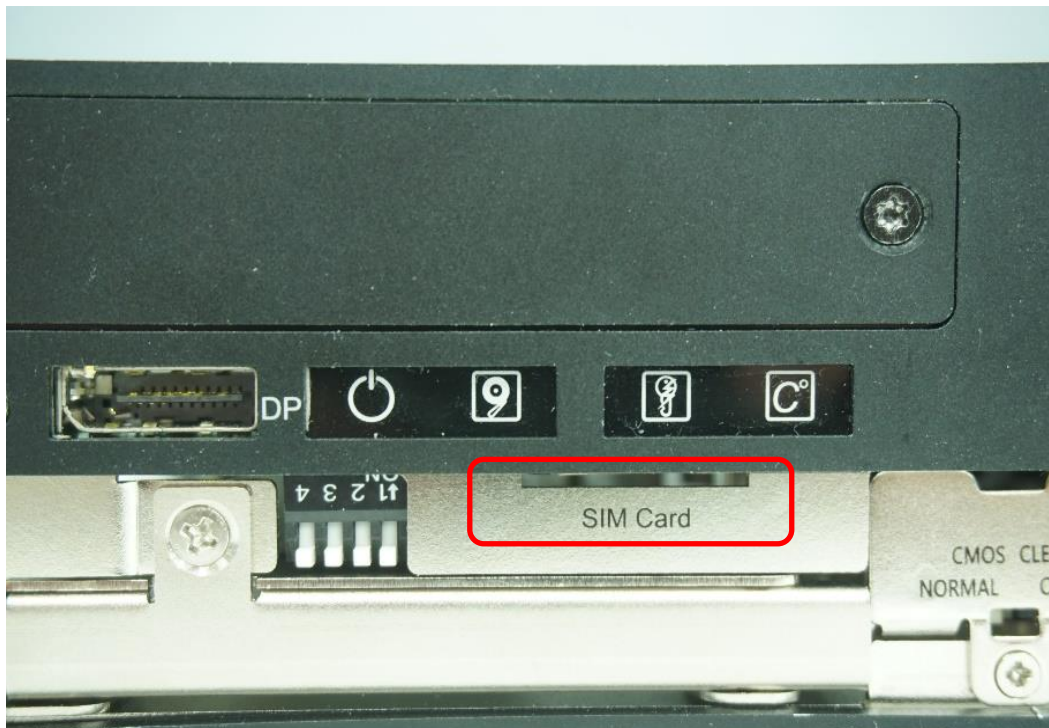

2. Insert a SIM card into SIM slot with the gold contacts facing up. Please pay attention to the insert orientation as illustrated.



3.17 Installing the CMOS Battery

1. Locate the removable CMOS Battery and loosen the screw.

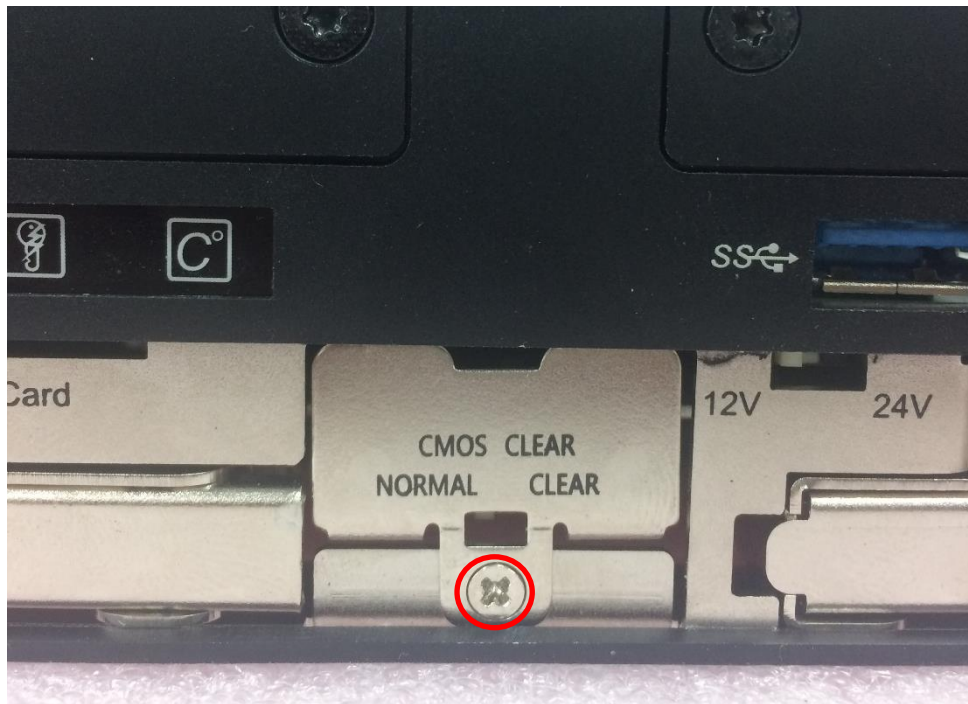

2. Pull out the CMOS battery bracket with assistance of a tweezer.



3. Insert a CMOS battery in the battery slot.

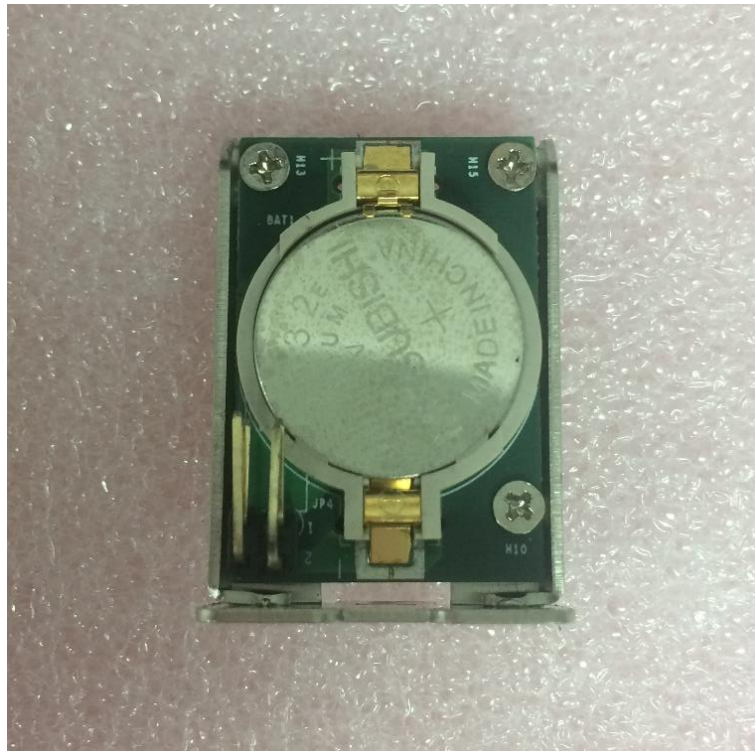

4. Insert the battery bracket firmly and fasten the screw.

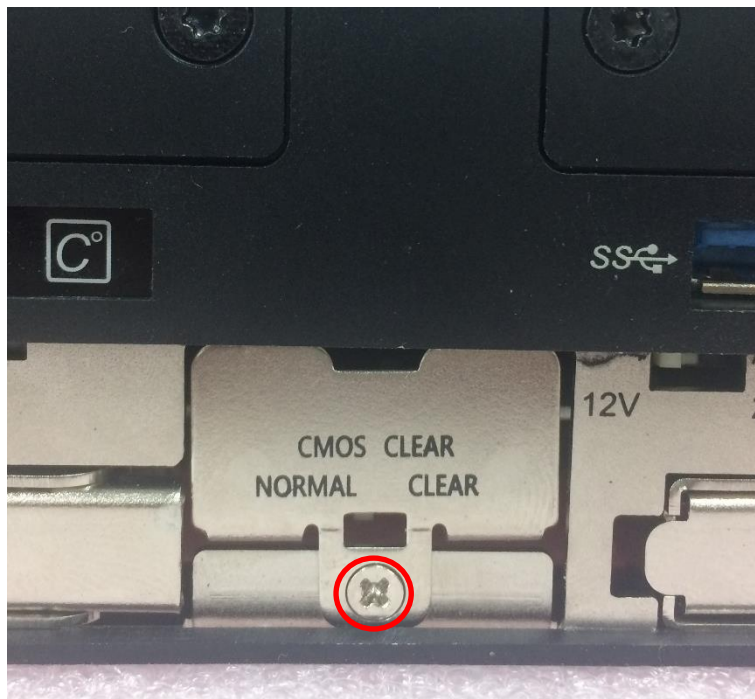

3.18 Fastening the Cover

1. Fasten the cover by using the two screws.



3.19 Installing an External Fan

1. Prepare an external fan. Loosen the 2 screws halfway on mounting frame before attempting to install it.

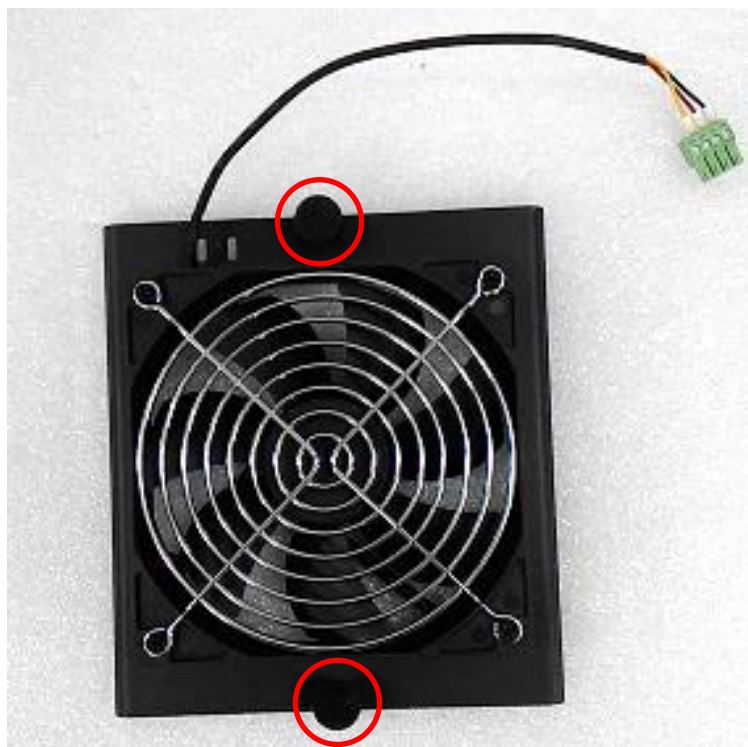

- Slide the FAN into the middle groove of chassis as illustrated. Tighten the 2 screws to fix it onto chassis.

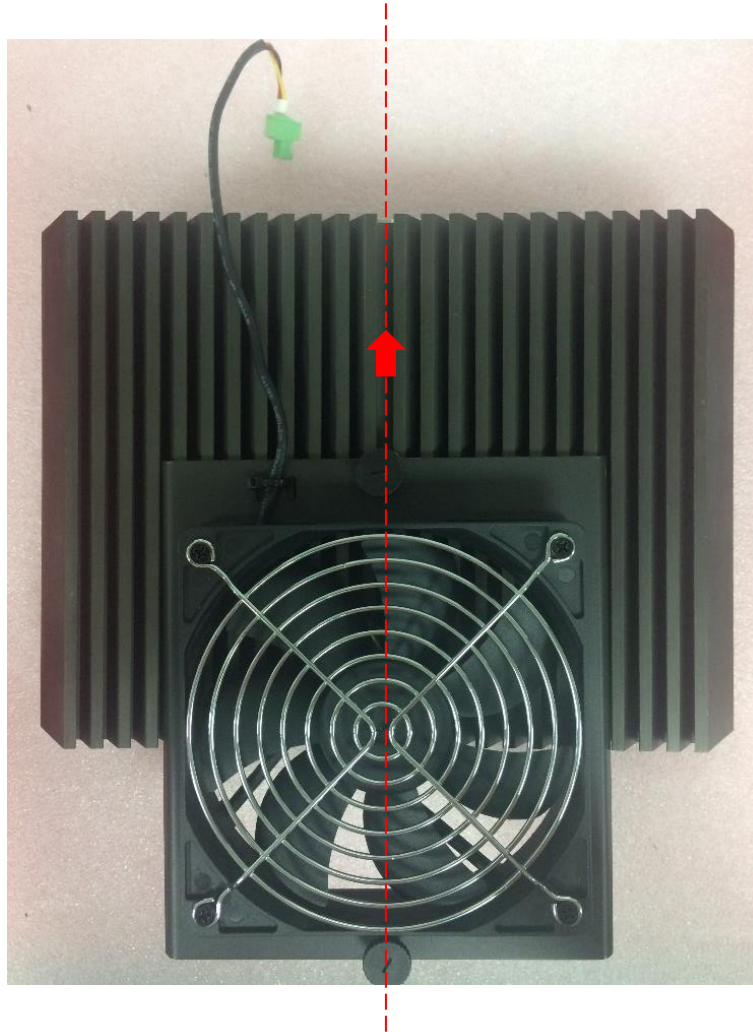

- Move the fan to the center of chassis. Tighten the 2 screws marked on photo to secure it.

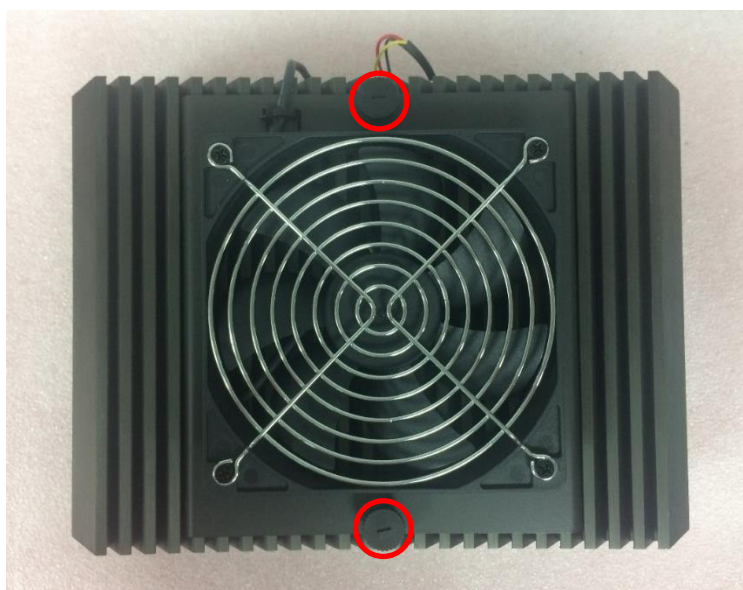

4. Connect the FAN cable to external fan power connector at rear panel.

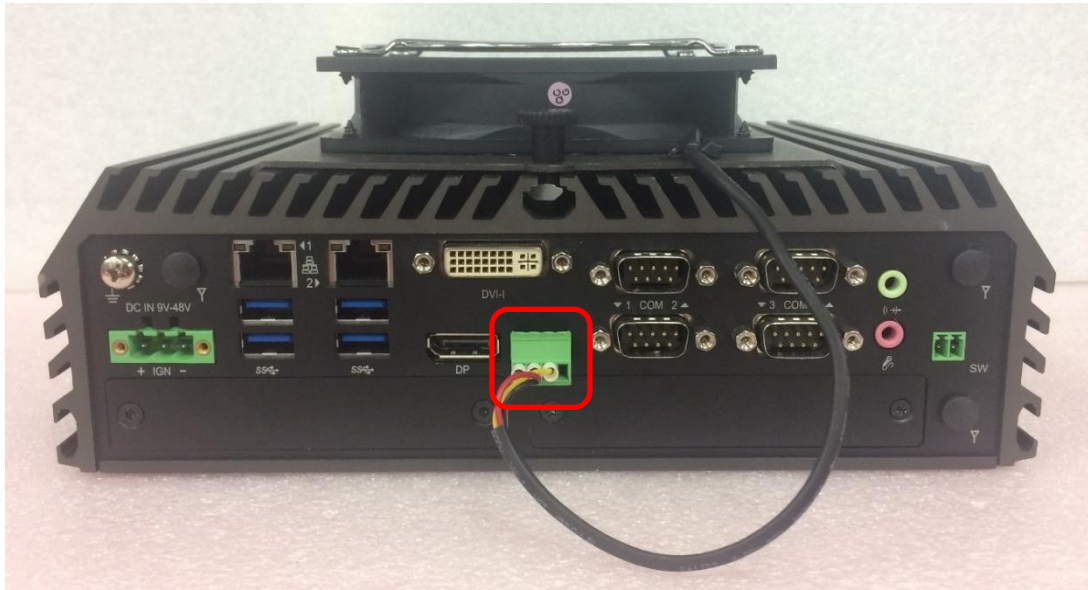

3.20 Wall Mount Brackets

DX-1000 series offers wall mount brackets that customers can install system on the wall in convenient and economical ways.

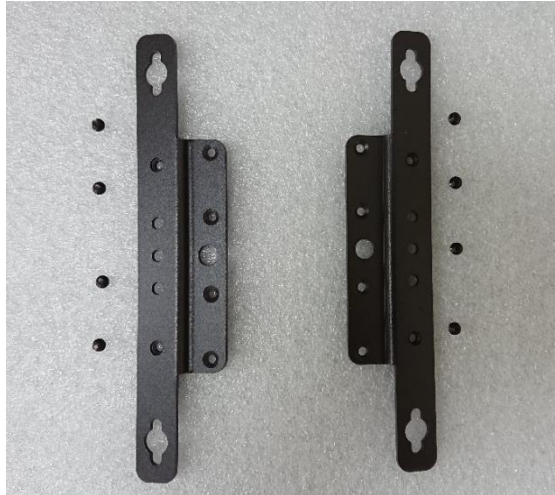

1. The mounting holes are at the bottom side of system. Use provided 8 screws to fasten the bracket on each side.

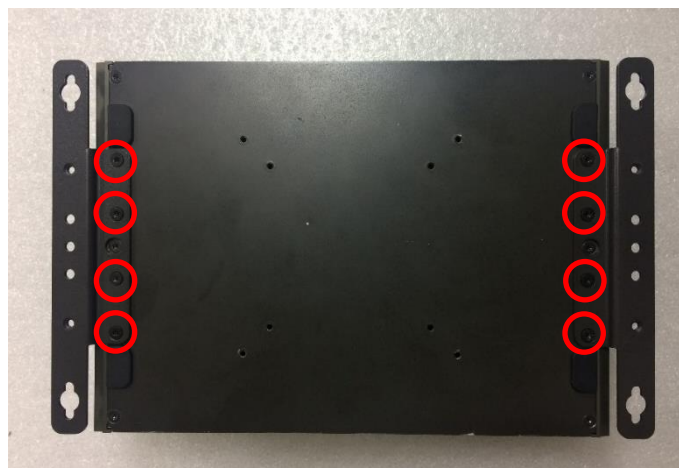

2. There are 2 bracket mounting holes at left and right side for customer fix the system on the wall.

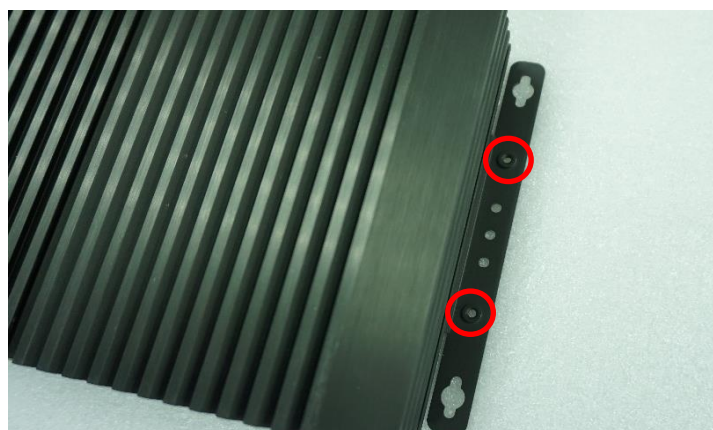

3.21 DIN-Rail Mount Brackets

DX-1000 series offers DIN-Rail Mount that customer can install system on the DIN Rail.

1. Please refer to section 3.20 Wall Mount Brackets to install mounting bracket at both sides of system.

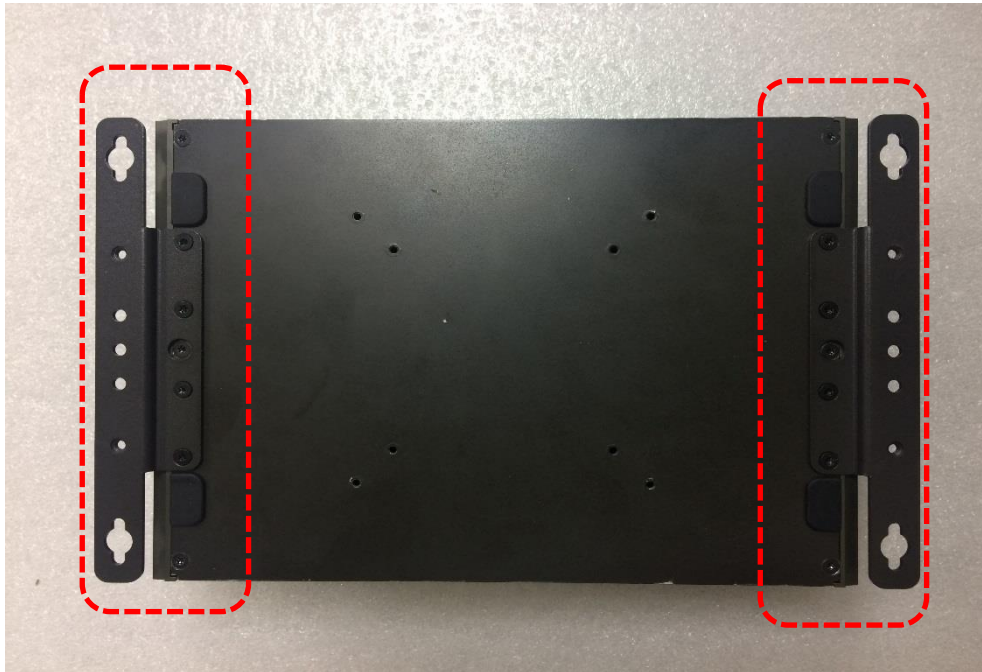

2. Fasten 2 DIN rail mounting clips to mounting brackets on both sides with provided 4 screws as illustrated.



3. Clip the system into DIN rail as illustrated by the following steps. (1) Have lower end of mounting clip snaps into the DIN rail. (2) Press the system toward to have upper end of mounting clip snaps into the other side of DIN rail.

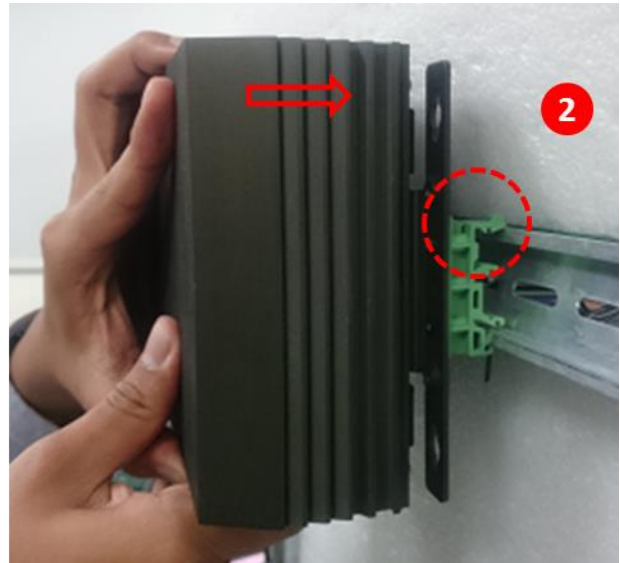

3.22 VESA Mount

DX-1000 series supports VESA mounting that customer can mount system with panel complying with VESA 75mm and 100 mm standard for various usage.

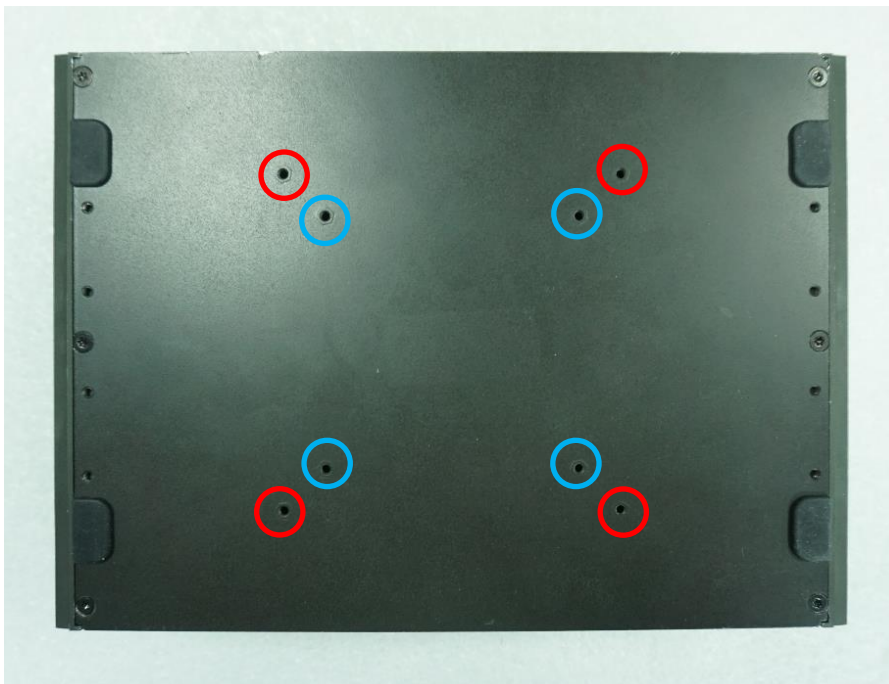

1. The following picture illustrates the installation of DX-1000 series on a VESA stand. Align the 4 screw holes of VESA stand with the screw holes on bottom side of system. Fasten 4 screws to fix it.

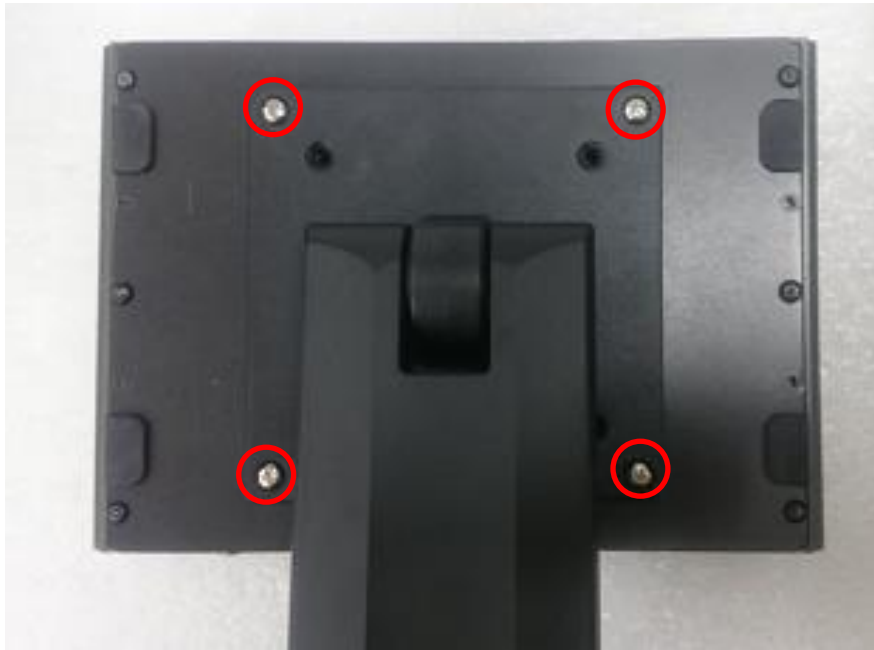

2. Provided below is mounted with VESA stand.



3.23 Side Mount Brackets

DX-1000 series offers Side Mount that customer can install system to the right or left side of wall to create effective of space.

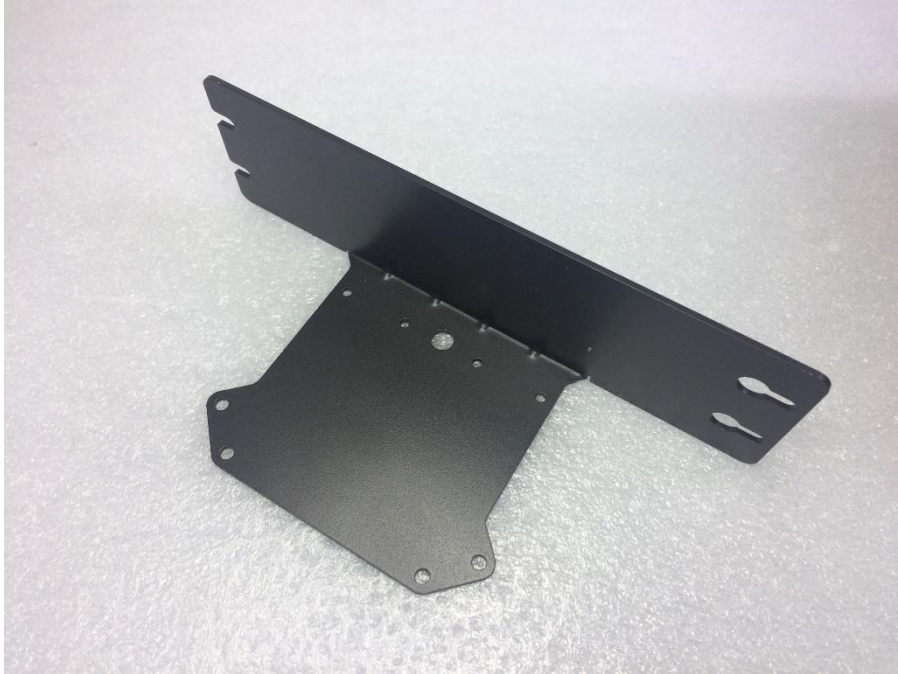

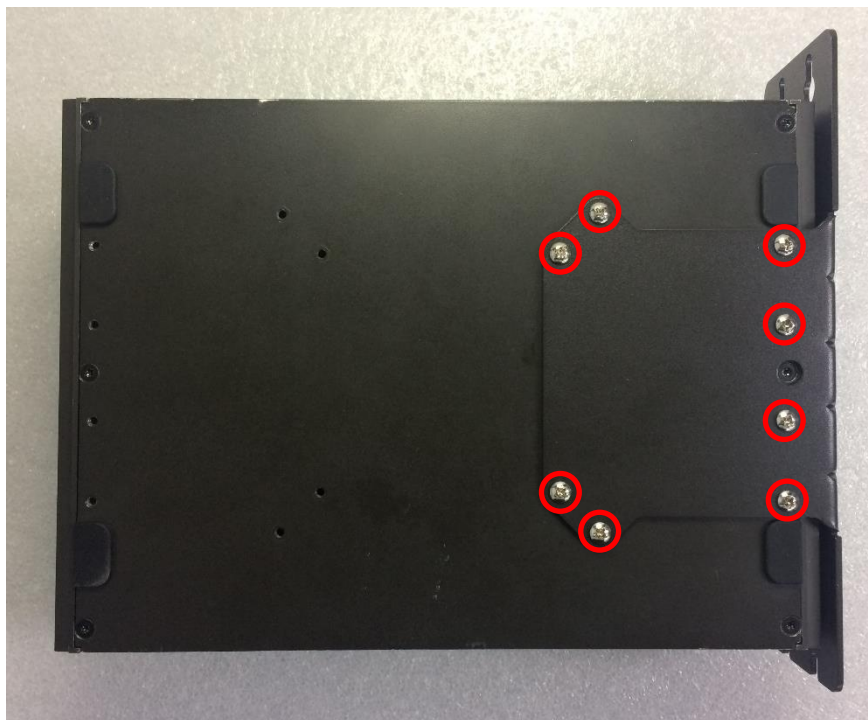

1. The mounting holes are at the bottom of system. Fasten the 8 screws to fix the side mount bracket with system together.



2. Fasten the screws through the bracket mounting hole to mount system on the wall.





Chapter 4

BIOS Setup

4.1 BIOS Introduction

The BIOS (Basic Input/ Output System) is a program located on a Flash Memory on the motherboard. When you start the computer, the BIOS program will gain control. The BIOS first operates an auto-diagnostic test called POST (power on self-test) for all the necessary hardware, it detects the entire hardware device and configures the parameters of the hardware synchronization.

BIOS Setup

Power on the computer and by pressing immediately allows you to enter Setup. If the message disappears before your respond and you still wish to enter Setup, restart the system to try again by turning it OFF then ON or pressing <Ctrl>, <Alt> and <Delete> keys.

Control Keys	
<←> <→>	Move to select screen
<↑> <↓>	Move to select item
<Esc>	Quit the BIOS Setup
<Enter>	Select item
<Page Up/+>	Increases the numeric value or makes changes
<Page Down/->	Decreases the numeric value or makes changes
<Tab>	Select setup fields
<F1>	General help
<F2>	Previous value
<F3>	Load Optimized defaults
<F10>	Save configuration and Exit

Main Menu

The main menu lists the setup functions you can make changes to. You can use the arrow keys (↑↓) to select the item. The on-line description of the highlighted setup function is displayed at the bottom of the screen.

Sub-Menu

If you find a right pointer symbol appears to the left of certain fields that means a sub-menu can be launched from this field. A sub-menu contains additional options for a field parameter. You can use arrow keys (↑↓) to highlight the field and press <Enter> to call up the sub-menu. Then you can use the control keys to enter values and move from field to field within a sub-menu. If you want to return to the main menu, just press the <Esc >.

4.2 Main Setup

Press to enter BIOS CMOS Setup Utility, the Main Menu (as shown below) will appear on the screen. Use arrow keys to move among the items and press <Enter> to accept or enter a sub-menu.

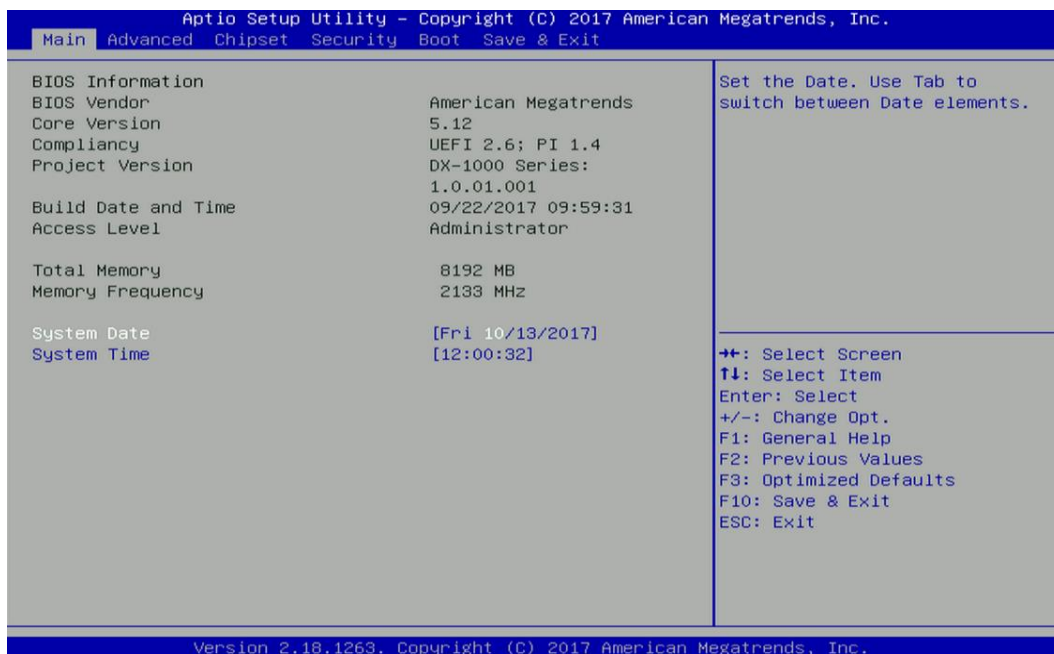

4.2.1 System Date

Set the date. Please use <Tab> to switch between date elements.

4.2.2 System Time

Set the time. Please use <Tab> to switch between time elements.

4.3 Advanced Setup

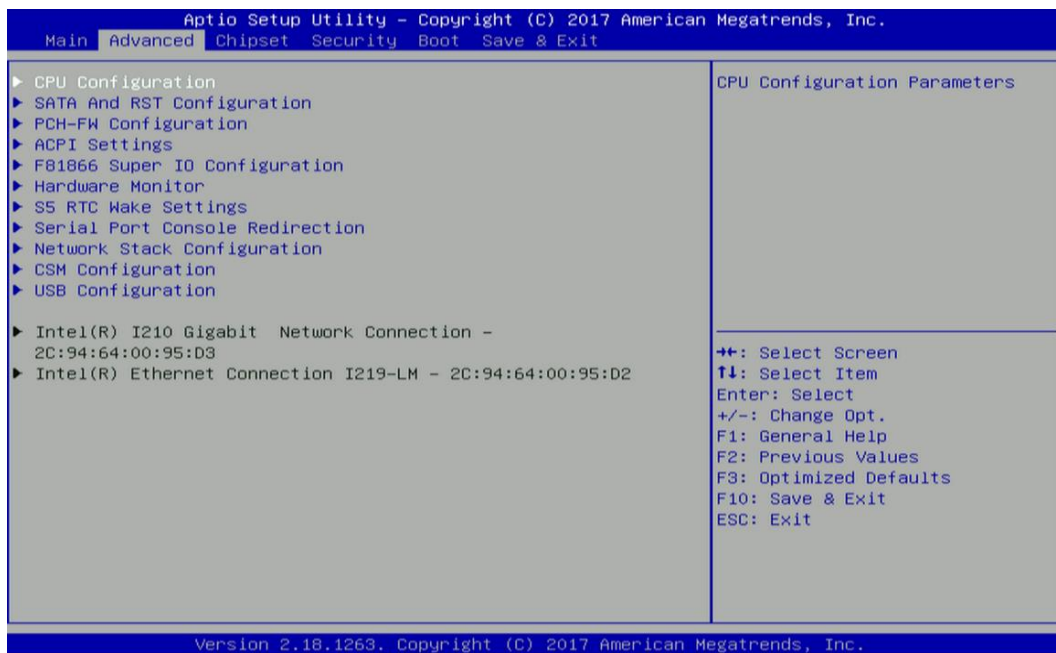

4.3.1 CPU Configuration

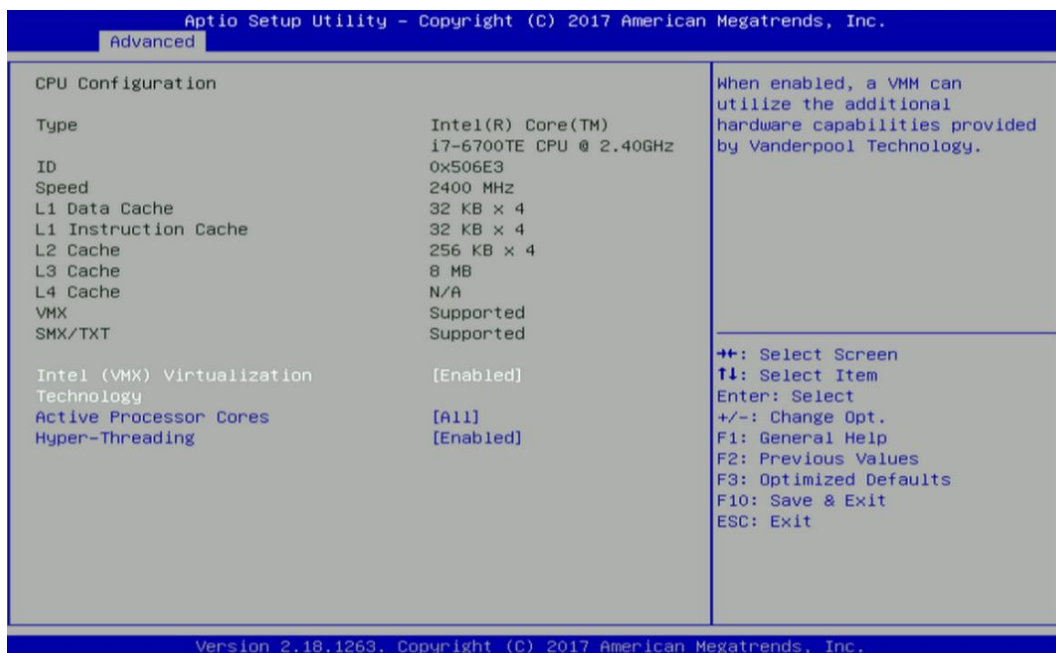

■ Intel® (VMX) Virtualization Technology

Enables or disables Intel® Virtualization Technology, which will allow a platform to run multiple operating systems and applications in independent partitions. With virtualization, one computer system can function as multiple virtual systems.

■ Active Process Cores

Allows you to choose the number of active processor cores.

Configuration options: [All] [1].

4.3.2 SATA And RST Configuration

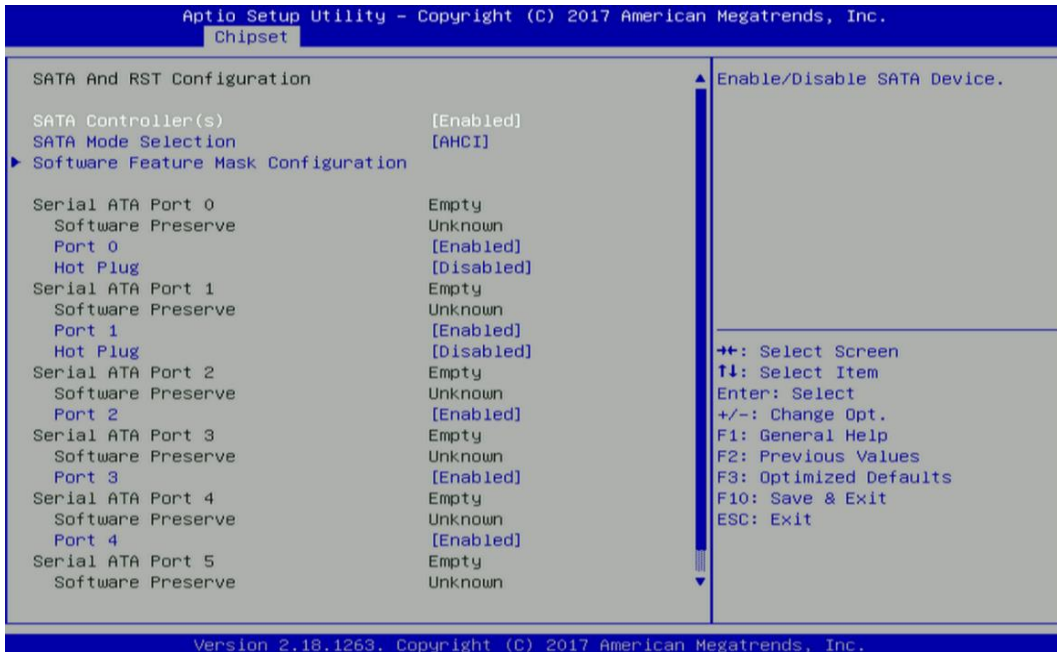

■ SATA Controller(s) [Enabled]

Enables or disables SATA device.

■ SATA Mode Selection [AHCI]

Allows you to select which mode SATA controller will operate.

Configuration options: [AHCI], [RAID]

□ Serial ATA Port 0

Port 0 [Enabled]

Enables or disables SATA Port 0.

Hot Plug [Disabled]

Enables or disables Port0 as Hot Pluggable.

□ Serial ATA Port 1

Port 1 [Enabled]

Enables or disables SATA Port 1.

Hot Plug [Disabled]

Enables or disables Port0 as Hot Pluggable.

□ Serial ATA Port 2

Port 1 [Enabled]

Enables or disables SATA Port 2.

□ Serial ATA Port 3

Port 1 [Enabled]

Enables or disables SATA Port 3.

□ Serial ATA Port 4

Port 1 [Enabled]

Enables or disables SATA Port 4.

Serial ATA Port 5

Port 1 [Enabled]

Enables or disables SATA Port 5.

■ Software Feature Mask Configuration

RAID OROM(Option ROM) / RST(Intel® Rapid Storage Technology) driver will refer to the software feature configuration to enable or disable the storage features.

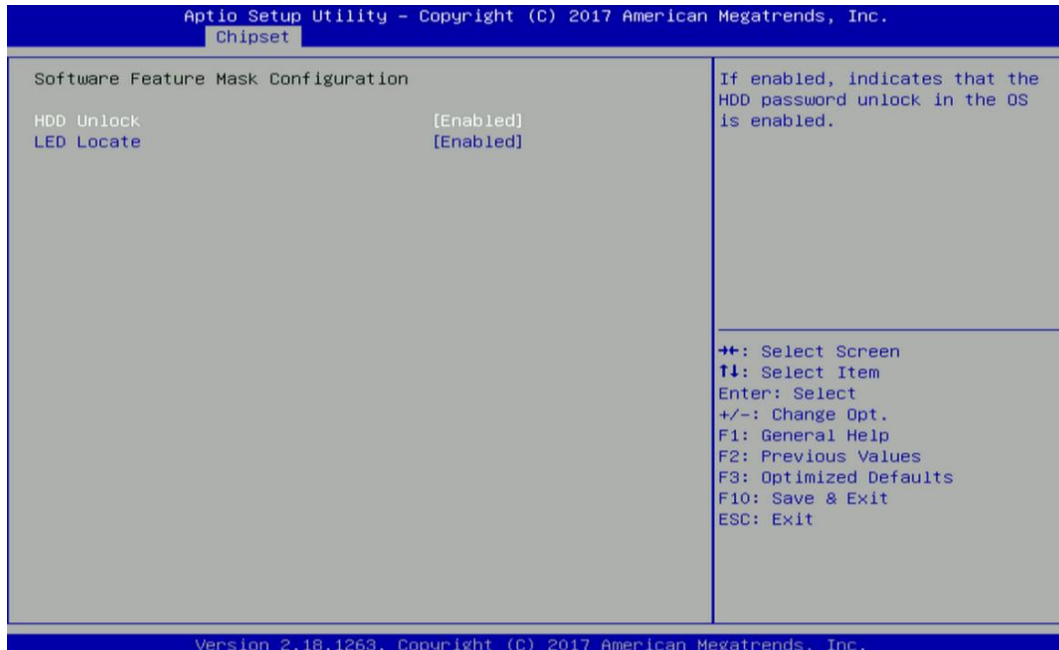

HDD Unlock

Enables or disables HDD Unlock.

LED Locate

Enables or disables LED Locate

4.3.3 PCH-FW Configuration

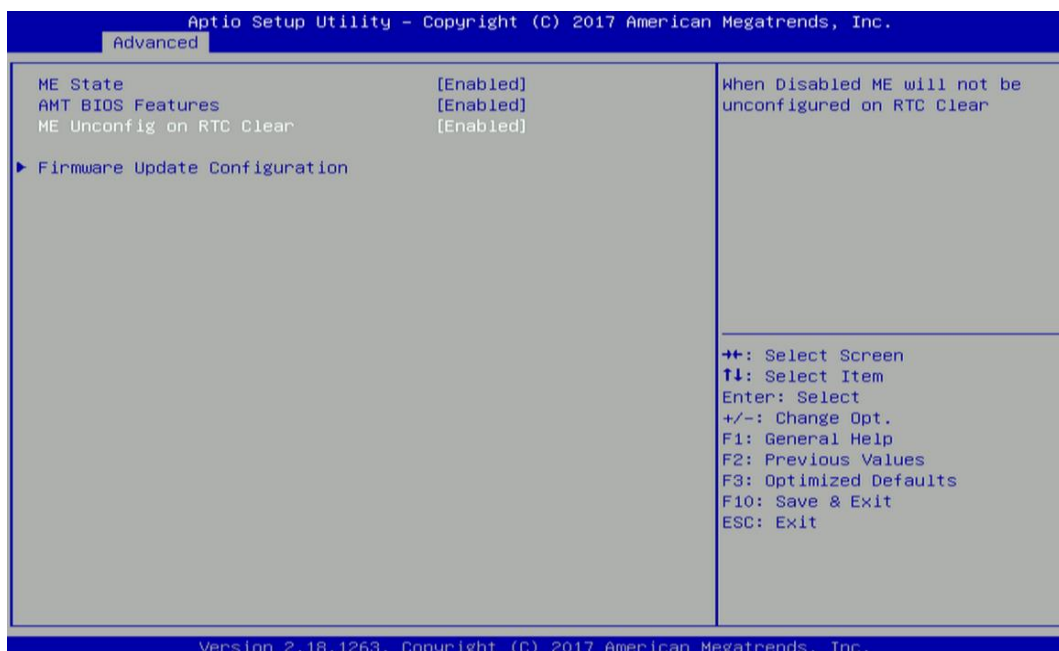

■ ME State

Enables or disables PCH-FW Configuration

■ Manageability Features State

Enables or disables

■ ME Unconfig on RTC Clear

Enables or disables

■ Firmware Update Configuration

Configure Management Engine Parameters

□ Me FW Image Re-Flash

Enables or disables ME firmware Image Re-Flash function.

4.3.4 ACPI Settings

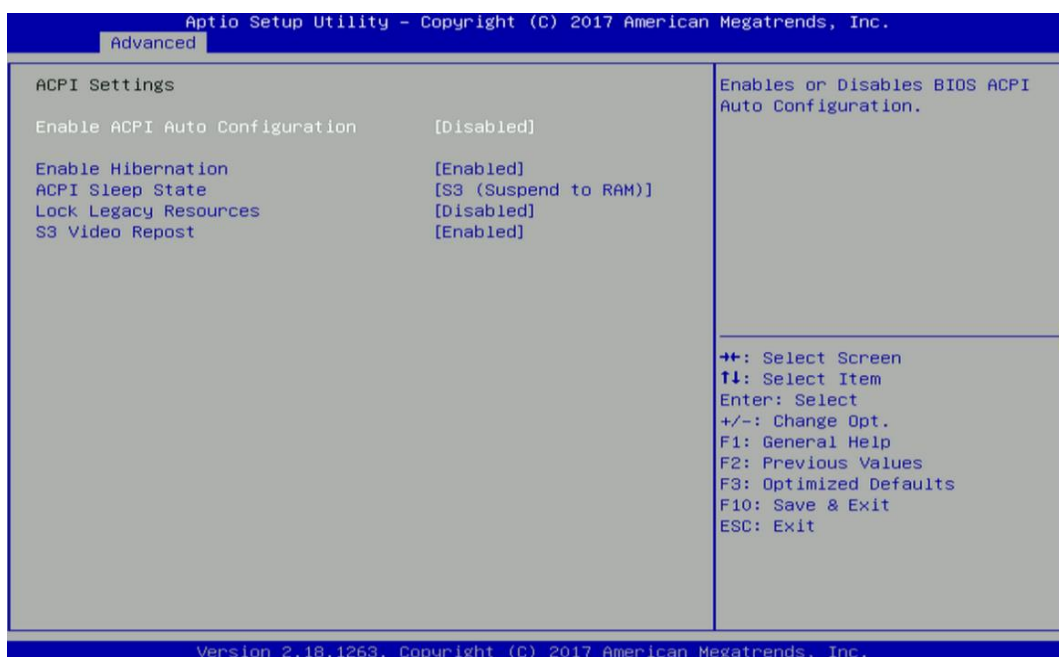

■ Enable ACPI Auto Configuration [Disabled]

Enables or disables BIOS Advanced Configuration Power Interface® (ACPI) auto configuration.

■ Enable Hibernation [Enabled]

Enables or disables system ability to hibernate state (OS/S4 state). This option may not be effective with some OS.

■ ACPI Sleep State [S3 (Suspend to RAM)]

Allows users to select the highest Advanced Configuration Power Interface® (ACPI) sleep state that system will enter when suspend button is pressed.

[Suspend Disabled]: Disables entering suspend state.

[S3 (suspend to RAM)]: Enables suspend to RAM state.

■ Lock Legacy Resources [Disabled]

Enables or disables Lock Legacy Resources.

■ S3 Video Repost [Enabled]

Enable or disable S3 Video Repost.

4.3.5 F81866 Super IO Configuration

Set Parameters of Serial Ports. User can Enable/Disable the serial port and Select an optimal setting for the Super IO Device.

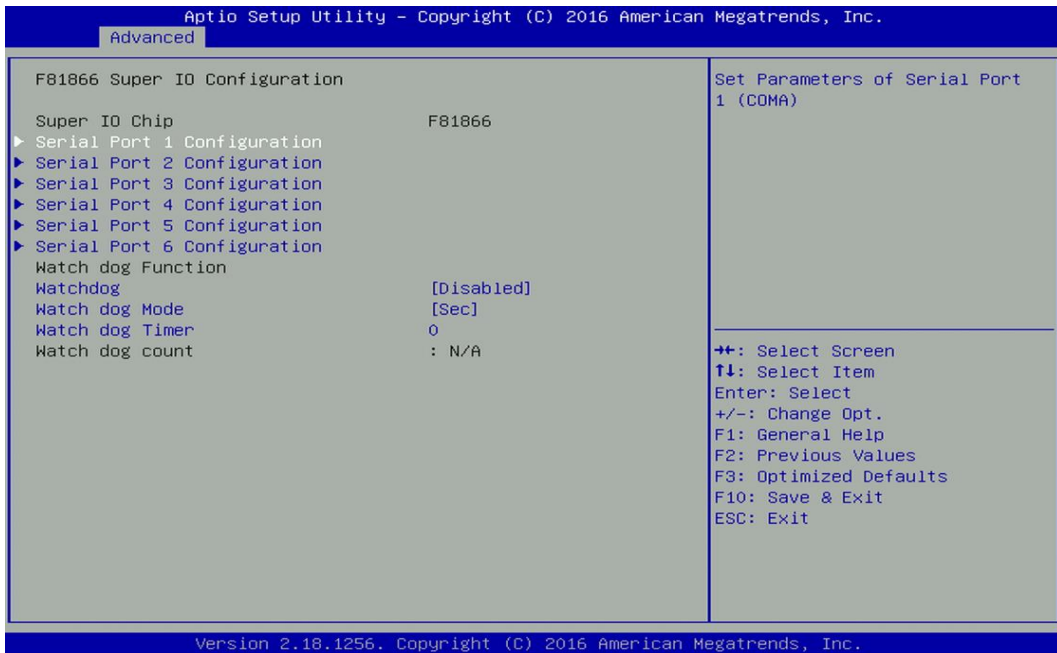

■ Serial Port 1~6 Configuration.

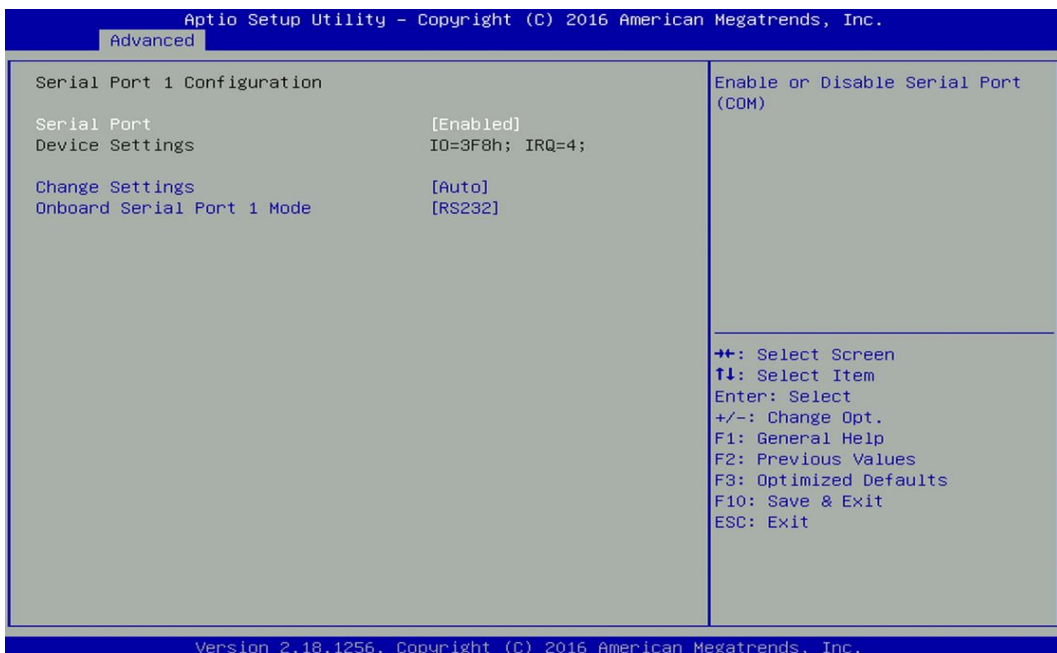

Serial Port [Enabled]

Enables or disables serial port.

Change Settings [Auto]

Allows you to change the IO Address & IRQ settings of the specified serial port.

Onboard Serial Port 1~6 Mode [RS232]

Allows you to select Serial Port Mode.

Configuration options: [RS232] [RS422/RS485 Full Duplex] [RS485 Half Duplex]

■ Watch Dog [Disabled]

Enables or disables watch dog function.

■ Watch Dog Mode [Sec]

Allows to set watchdog timer unit <Sec> or <Min>.

■ Watch Dog Timer [0]

Allows you to set watchdog timer's value in the range of 0 to 255.

4.3.6 Hardware Monitor

This screen displays the current status of all monitored hardware devices/components such as voltages, temperatures and all fans' speeds.

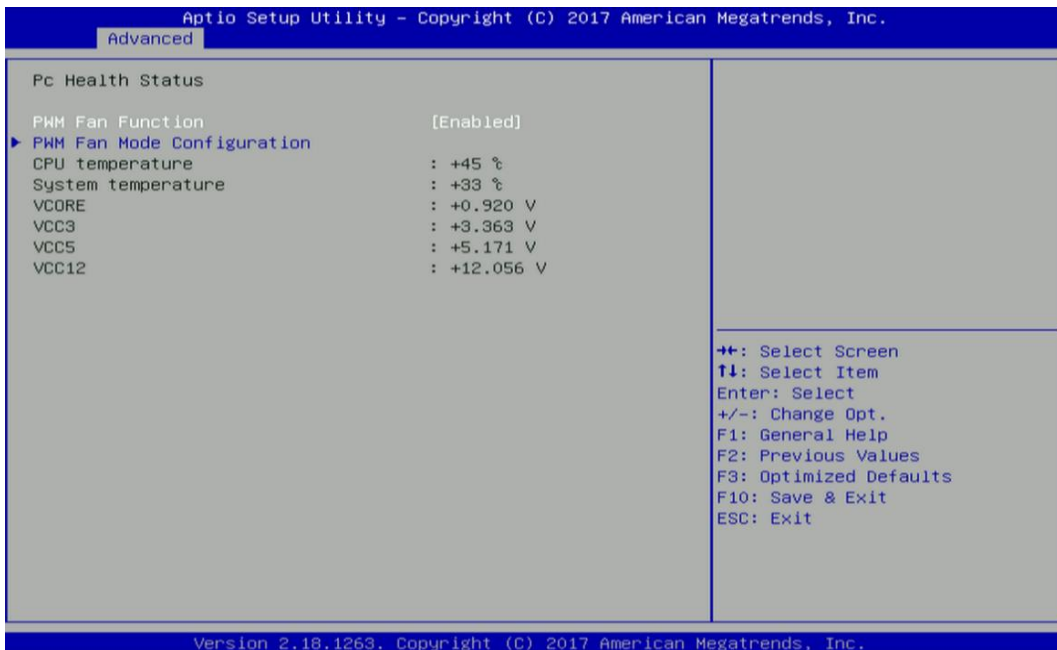

■ PWM Fan Function [Enabled]

Enables or disables PWM Fan function.

4.3.7 S5 RTC Wake Settings

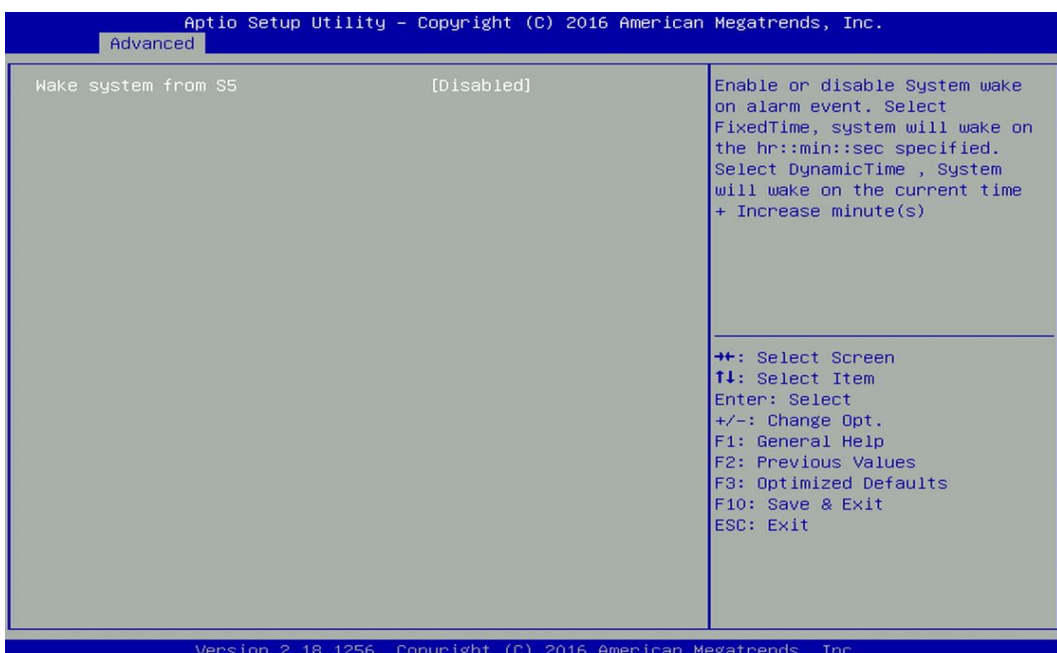

■ Wake system from S5 [Disabled]

Enables or disables wake system from S5 (soft-off state).

[Disabled]: Disables wake system from S5.

[Fixed Time]: Sets a fixed time (HH:MM:SS) to wake system from S5.

[Dynamic Time]: Sets an increase minute(s) from current time to wake system from S5.

4.3.8 Serial Port Console Redirection

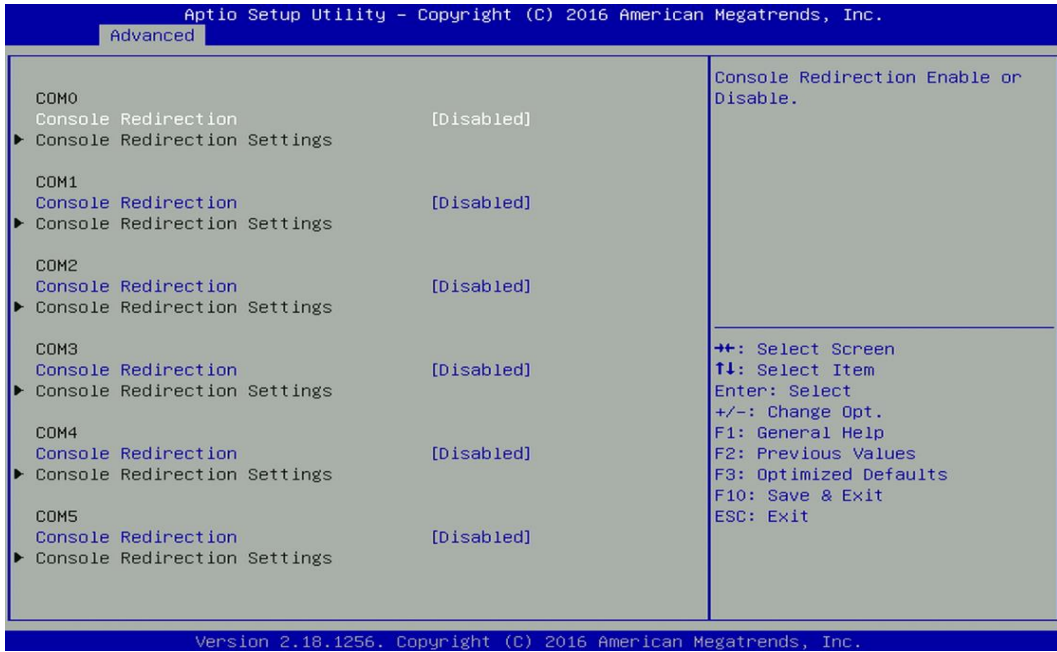

■ Console Redirection

Allow users to enable or disable COM0, COM1, COM2, COM3, COM4, COM5 console redirection function.

COM0 = Serial Port 1

COM1 = Serial Port 2

COM2 = Serial Port 3

COM3 = Serial Port 4

COM4 = Serial Port 5

COM5 = Serial Port 6

4.3.9 Network Stack Configuration

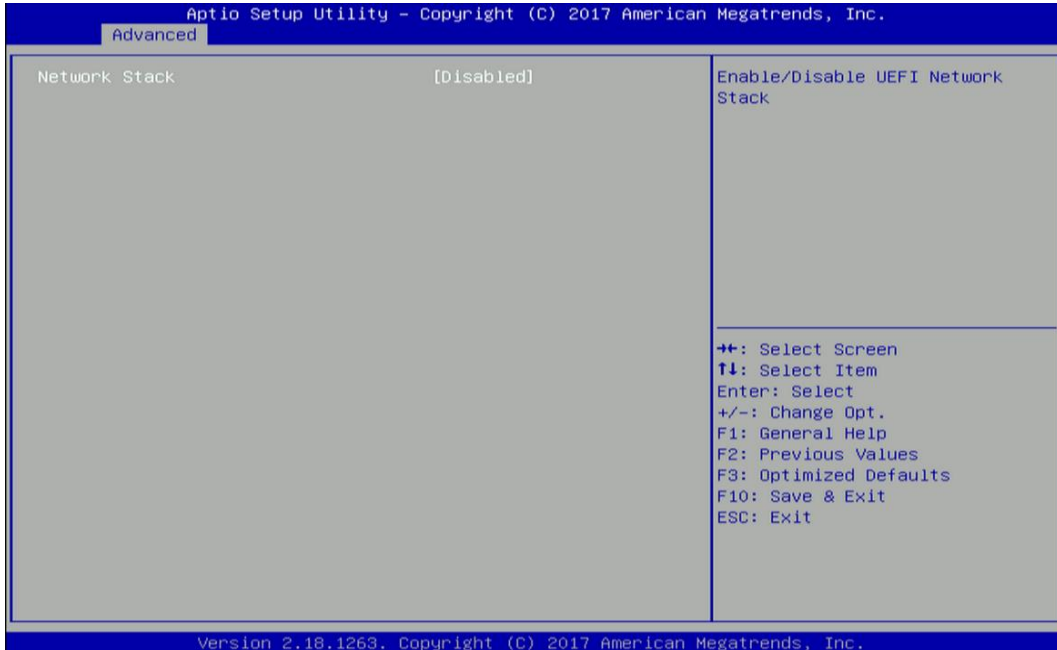

■ Network Stack [Disabled]

Enables or disables UEFI Network Stack.

4.3.10 CSM Configuration

This option controls legacy/UEFI ROMs priority.

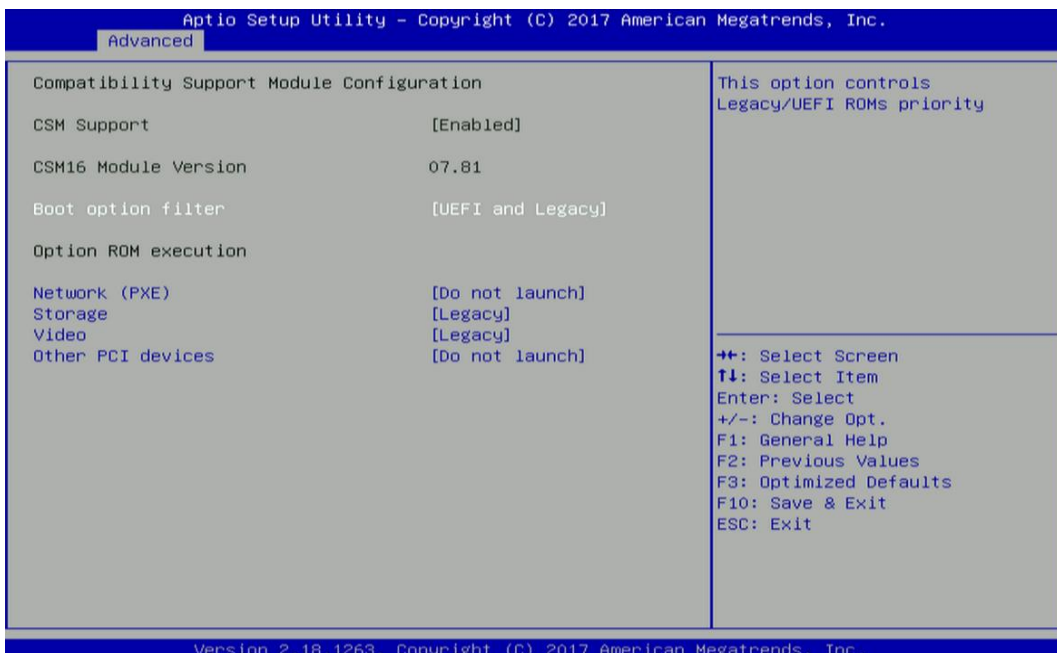

■ CSM Support [Enabled]

Enables or disables compatibility support module.

■ Boot option filter [UEFI and Legacy]

Allows you to select which type of operating system to boot.

[UEFI and Legacy]: Allows booting from operating systems that support legacy option ROM or UEFI option ROM.

[Legacy only]: Allows booting from operating systems that only support legacy option ROM.

[UEFI only]: Allows booting from operating systems that only support UEFI option ROM.

■ Network PXE [Do not launch]

Controls the execution of UEFI and Legacy PXE (Network Preboot eXecution Environment) option ROM.

[Do not launch]: Disables option ROM execution.

[UEFI]: Enables UEFI option ROM only.

[Legacy]: Enables legacy option ROM only.

■ Storage [Legacy]

Controls the execution of UEFI and Legacy Storage option ROM.

[Do not launch]: Disables option ROM execution.

[UEFI]: Enables UEFI option ROM only.

[Legacy]: Enables legacy option ROM only.

■ Video [Legacy]

Controls the execution of UEFI and Legacy Video option ROM.

[Do not launch]: Disables option ROM execution.

[UEFI]: Enables UEFI option ROM only.

[Legacy]: Enables legacy option ROM only.

■ Other PCI devices [Do not launch]

Allows users to determine option ROM execution policy for device other than network, storage, or video.

4.3.11 USB Configuration

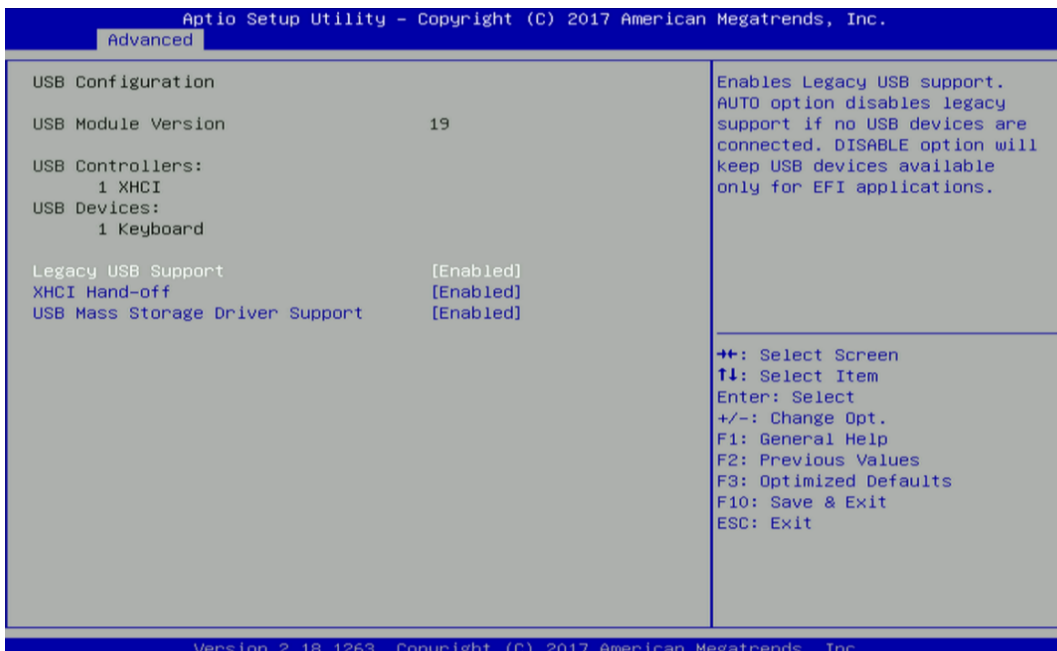

■ Legacy USB Support [Enabled]

This item allows you to enable or disable legacy USB support. When set to [Auto], legacy USB support will be disabled automatically if no USB devices are connected.

■ XHCI Hand-off [Enabled]

Enables or disables XHCI (USB3.0) hand-off function. Use this feature as a workaround for operating systems without XHCI hand-off support.

■ **USB Mass Storage Driver Support [Enabled]**

Enables or disables USB mass storage driver support.

4.4 Chipset Setup

This section allows you to configure chipset related settings according to user's preference.

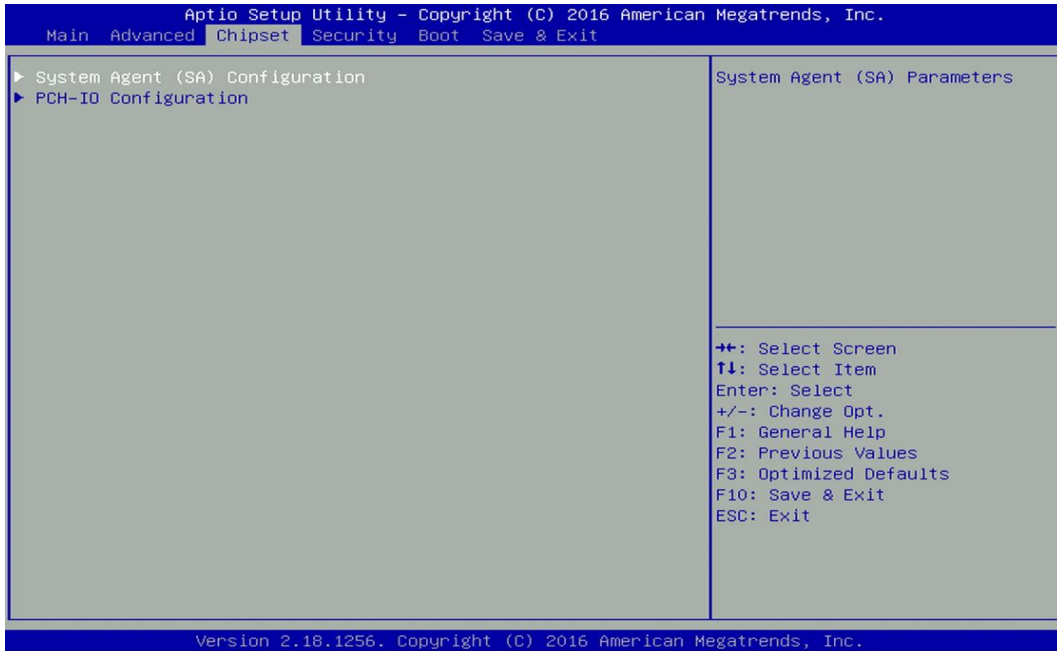

4.4.1 System Agent (SA) Configuration

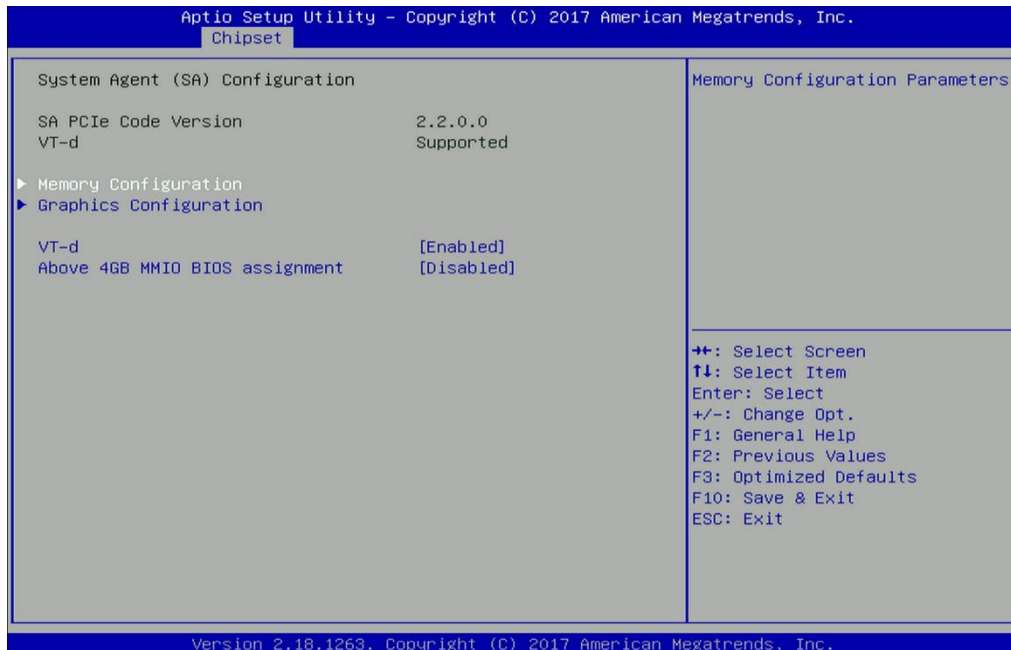

■ **VT-d [Enabled]**

Enables or disables Intel® Virtualization Technology for Directed I/O (VT-d) capability.

■ **Above 4GB MMIO BIOS assignment [Disabled]**

Enables or disables Above 4GB Memory Mapped IO BIOS assignment. This is disabled automatically when Aperture Size is set to 2048MB.

■ Memory Configuration

This item displays detailed memory configuration in the system.

■ Graphics Configuration

□ Primary Display [Auto]

Allows users to select which graphics device should be primary display or select SG for switchable graphics.

Configuration options: [Auto] [IGFX] [PEG] [PCIe]

□ Internal Graphics [Auto]

Allows users to enable or disable Internal Graphics.

Configuration options: [Auto] [Disabled] [Enabled]

4.4.2 PCH-IO Configuration

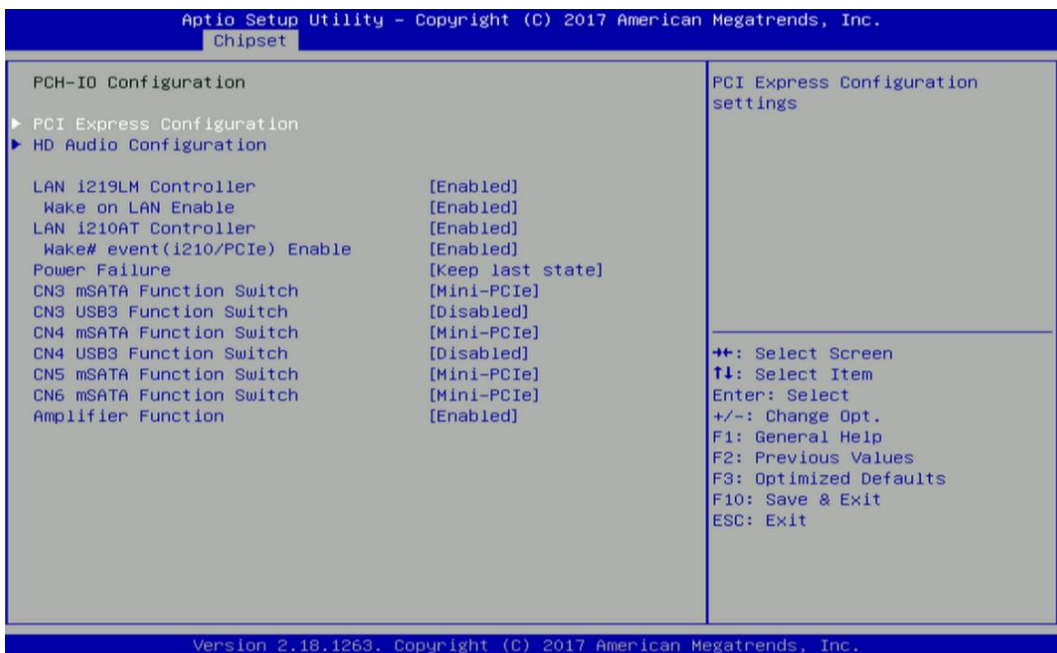

■ PCI Express Configuration

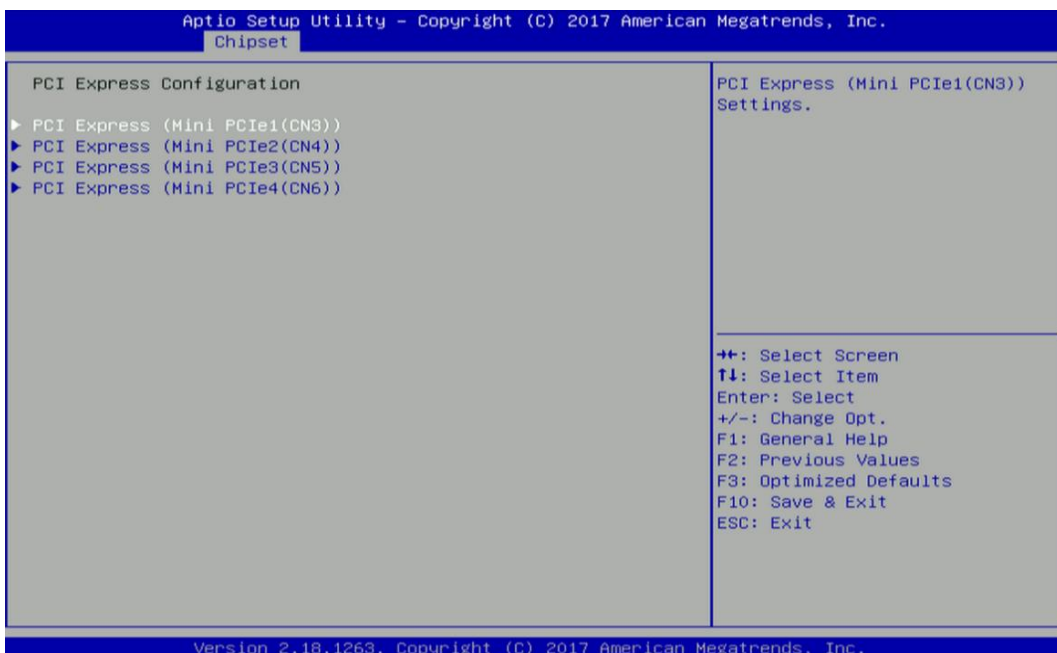

- ❑ **PCI Express (Mini PCIe1 (CN3))**
 - **PCI Express (Mini PCIe1 (CN3)) [Enabled]**
Enables or disables PCI Express Root Port.
 - **PCIe Speed [Auto]**
Allows you to select PCI Express interface speed.
Configuration options: [Auto] [Gen1] [Gen2] [Gen3].
- ❑ **PCI Express (Mini PCIe1 (CN4))**
 - **PCI Express (Mini PCIe1 (CN4)) [Enabled]**
Enables or disables PCI Express Root Port.
 - **PCIe Speed [Auto]**
Allows you to select PCI Express interface speed.
Configuration options: [Auto] [Gen1] [Gen2] [Gen3].
- ❑ **PCI Express (Mini PCIe1 (CN5))**
 - **PCI Express (Mini PCIe1 (CN5)) [Enabled]**
Enables or disables PCI Express Root Port.
 - **PCIe Speed [Auto]**
Allows you to select PCI Express interface speed.
Configuration options: [Auto] [Gen1] [Gen2] [Gen3].
- ❑ **PCI Express (Mini PCIe1 (CN6))**
 - **PCI Express (Mini PCIe1 (CN6)) [Enabled]**
Enables or disables PCI Express Root Port.
 - **PCIe Speed [Auto]**
Allows you to select PCI Express interface speed.
Configuration options: [Auto] [Gen1] [Gen2] [Gen3].

■ **LAN i219LM Controller [Enabled]**

Enables or disables i219LM LAN Controller.

■ **Wake on LAN Enabled [Enabled]**

Enables or disables integrated LAN Wake On LAN function.

■ **LAN i210AT Controller [Enabled]**

Enables or disables i210AT LAN Controller.

■ **Power Failure [Keep last state]**

Allows you to specify which power state system will enter when power is resumed after a power failure (G3 state).

[Always on]: Enters to power on state.

[Always off]: Enters to power off state.

[Keep last state]: Enters to the last power state before a power failure.

■ **CN3 mSATA Function Switch [Mini-PCIe]**

Allows you to change **Mini PCIe1 (CN3)** as [Mini-PCIe] or [mSATA].

■ **CN3 USB3 Function Switch [Disabled]**

Enables or disables CN3 USB3 Controller.

■ CN4 mSATA Function Switch [Mini-PCIe]

Allows you to change **Mini PCIe1 (CN4)** as [Mini-PCIe] or [mSATA].

■ CN4 USB3 Function Switch [Disabled]

Enables or disables CN4 USB3 Controller.

■ CN5 mSATA Function Switch [Mini-PCIe]

Allows you to change **Mini PCIe1 (CN5)** as [Mini-PCIe] or [mSATA].

■ CN6 mSATA Function Switch [Mini-PCIe]

Allows you to change **Mini PCIe1 (CN6)** as [Mini-PCIe] or [mSATA].

■ Amplifier Function [Enabled]

Enables or disables Amplifier Function.

4.5 Security Setup

This section allows users to configure BIOS security settings.

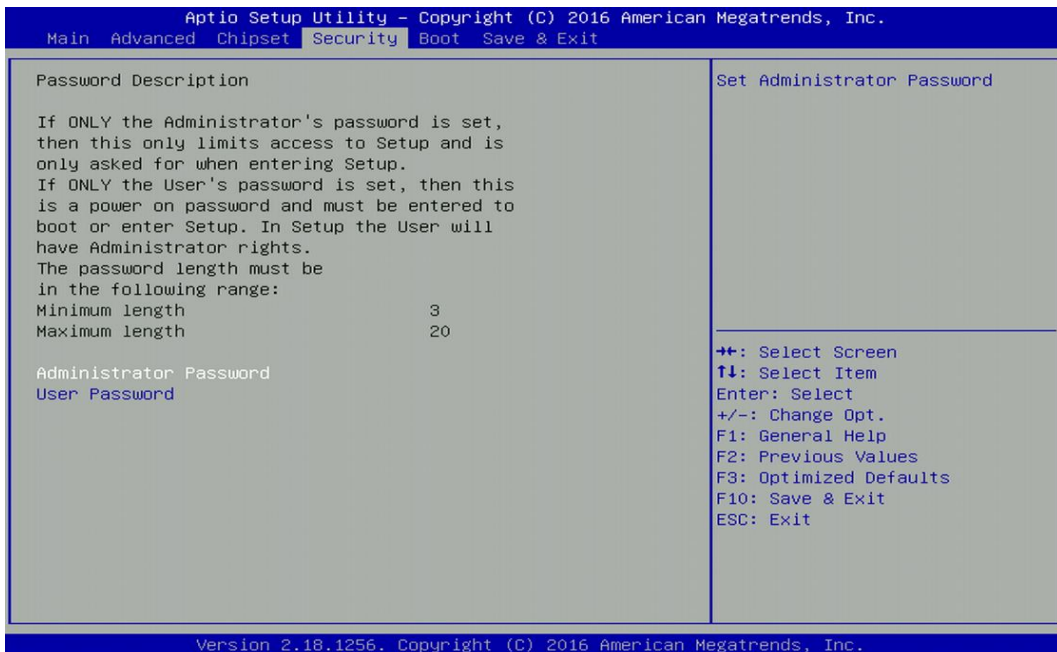

4.5.1 Administrator Password

Administrator Password controls access to the BIOS Setup utility.

4.5.2 User Password

User Password controls access to the system at boot and to the BIOS Setup utility.

4.6 Boot Setup

This section allows you to configure Boot settings.

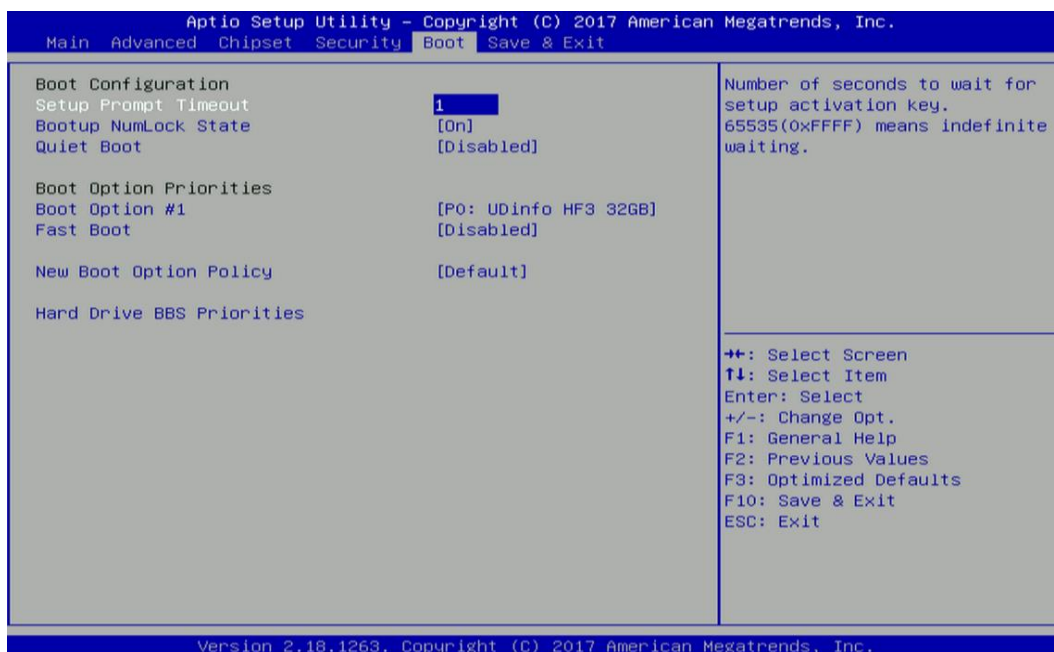

4.6.1 Setup Prompt Timeout

Use this item to set number of seconds (1..65535) to wait for setup activation key.

4.6.2 Bootup NumLock State

Allows you to set NumLock key to [On] or [Off] state when system boots up.

4.6.3 Quiet Boot

Allows you to enable or disable Quiet Boot function.

4.6.4 Fast Boot

Allows you to enable or disable Fast Boot function. If enabled, system boots with initialization of a minimal set of devices required to launch active boot option.

4.6.5 New Boot Option Policy

Allows you to change New Boot Option Policy.

Configuration options: [Default] [Place First] [Place Last].

4.6.6 Hard Drive BBS Priority

Allows you to set the order of the legacy devices in this group.

4.7 Save & Exit

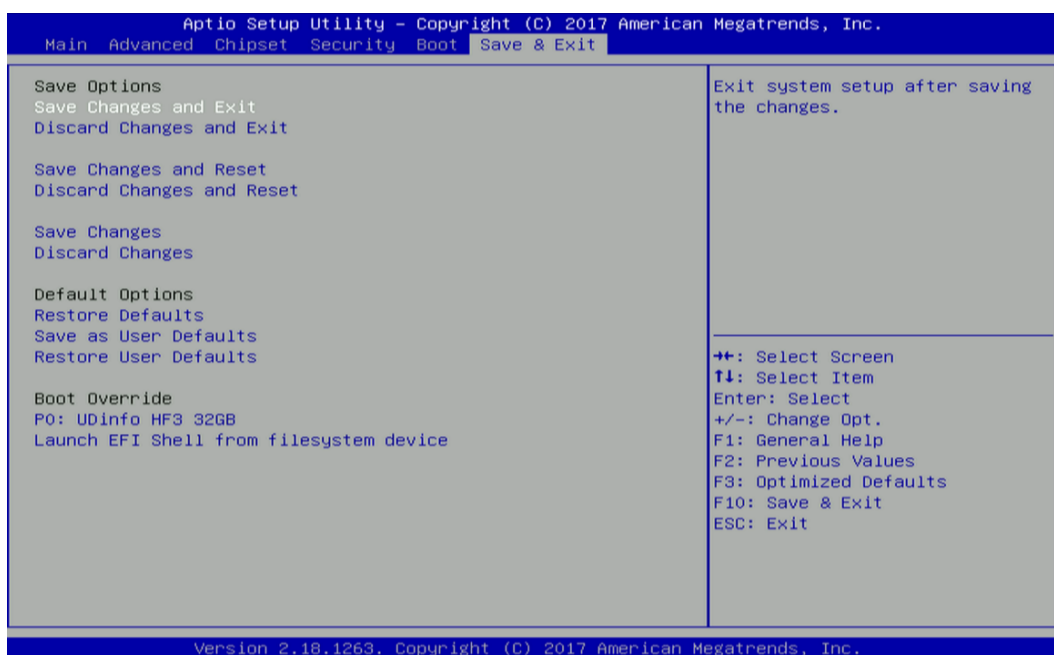

4.7.1 Save Changes and Exit

This item allows you to exit system setup after saving changes.

4.7.2 Discard Changes and Exit

This item allows you to exit system setup without saving changes.

4.7.3 Save Changes and Reset

This item allows you to reset the system after saving changes.

4.7.4 Discard Changes and Reset

This item allows you to reset system setup without saving any changes.

4.7.5 Save Changes

This item allows you to save changes done so far to any of the setup options.

4.7.6 Discard Changes.

This item allows you to discard changes done so far to any of the setup options.

4.7.7 Restore Defaults

This item allows you to restore/ load default values for all the setup options.

4.7.8 Save as User Defaults

This item allows you to save the changes done so far as user defaults.

4.7.9 Restore User Defaults

This item allows you to restore the user defaults to all the setup options.



Chapter 5

Product Application

(For DIO Only)

5.1 Digital I/O (DIO) application

This section describes DIO application of the product. The content and application development are better understood and implemented by well experienced professionals or developers.

5.1.1 Digital I/O Programming Guide

5.1.1.1 Pins for Digital I/O

Item	Standard
GPIO70 (Pin103)	DI
GPIO71 (Pin104)	
GPIO72 (Pin105)	
GPIO73 (Pin106)	
GPIO74 (Pin107)	
GPIO75 (Pin108)	
GPIO76 (Pin109)	
GPIO77 (Pin110)	
GPIO80 (Pin111)	
GPIO81 (Pin112)	
GPIO82 (Pin113)	
GPIO83 (Pin114)	
GPIO84 (Pin115)	
GPIO85 (Pin116)	
GPIO86 (Pin117)	
GPIO87 (Pin118)	

5.1.1.2 Programming Guide

To program the Super I/O chip F81866A configuration registers, the following configuration procedures must be followed in sequence:

- (1) Enter the Extended Function Mode
- (2) Configure the configuration registers
- (3) Exit the Extended Function Mode

The configuration register is used to control the behavior of the corresponding devices. To configure the register, use the index port to select the index and then write data port to alter the parameters. The default index port and data port are 0x4E and 0x4F, respectively.

Pull down the SOUT1 pin to change the default value to 0x2E/ 0x2F. To enable configuration, the entry key 0x87 must be written to the index port. To disable configuration, write exit entry key 0xAA to the index port.

Following is an example to enable configuration and to disable configuration by using debug.

- o 4e 87
- o 4e 87 (enable configuration)
- o 4e aa (disable configuration)

5.1.1.3 Relative Registers

To program the F81866A configuration registers, see the following configuration procedures.

Logic Device Number Register (LDN) — Index 07h

Bit	Name	R/W	Reset	Default	Description
7-0	LDN	R/W	LRESET#	00h	00h: Select FDC device configuration registers. 03h: Select Parallel Port device configuration registers. 04h: Select Hardware Monitor device configuration registers. 05h: Select KBC device configuration registers. 06h: Select GPIO device configuration registers. 07h: Select WDT device configuration registers. 0Ah: Select PME, ACPI and ERP device configuration registers. 10h: Select UART1 device configuration registers. 11h: Select UART2 device configuration registers. 12h: Select UART3 device configuration registers. 13h: Select UART4 device configuration registers. 14h: Select UART5 device configuration registers. 15h: Select UART6 device configuration registers. Otherwise: Reserved.

8.7.13.1 GPIO7 Output Enable Register — Index 80h

Bit	Name	R/W	Reset	Default	Description
7	GPIO77_OE	R/W	LRESET#	0	0: GPIO77 is in input mode. 1: GPIO77 is in output mode.
6	GPIO76_OE	R/W	LRESET#	0	0: GPIO76 is in input mode. 1: GPIO75 is in output mode.
5	GPIO75_OE	R/W	LRESET#	0	0: GPIO75 is in input mode. 1: GPIO75 is in output mode.
4	GPIO74_OE	R/W	LRESET#	0	0: GPIO74 is in input mode. 1: GPIO74 is in output mode.
3	GPIO73_OE	R/W	LRESET#	0	0: GPIO73 is in input mode. 1: GPIO73 is in output mode.
2	GPIO72_OE	R/W	LRESET#	0	0: GPIO72 is in input mode. 1: GPIO72 is in output mode.
1	GPIO71_OE	R/W	LRESET#	0	0: GPIO71 is in input mode. 1: GPIO71 is in output mode.
0	GPIO70_OE	R/W	LRESET#	0	0: GPIO70 is in input mode. 1: GPIO70 is in output mode.

8.7.13.3 GPIO7 Pin Status Register — Index 82h (This byte could be also read by base address + 3)

Bit	Name	R/W	Reset	Default	Description
7	GPIO77_IN	R	-	-	The pin status of GPIO77/STB#.
6	GPIO76_IN	R	-	-	The pin status of GPIO76/AFD#.
5	GPIO75_IN	R	-	-	The pin status of GPIO75/ERR#.
4	GPIO74_IN	R	-	-	The pin status of GPIO74/INIT#.
3	GPIO73_IN	R	-	-	The pin status of GPIO73/SLIN#.
2	GPIO72_IN	R	-	-	The pin status of GPIO72/ACK#.
1	GPIO71_IN	R	-	-	The pin status of GPIO71/BUSY.
0	GPIO70_IN	R	-	-	The pin status of GPIO70/PE/FANCTL3/PWM_DAC3.

8.7.14.2 GPIO8 Output Data Register — Index 89h (This byte could be also written by base address + 2)

Bit	Name	R/W	Reset	Default	Description
7	GPIO87_VAL	R/W	LRESET#	1	0: GPIO87 outputs 0 when in output mode. 1: GPIO87 outputs 1 when in output mode.
6	GPIO86_VAL	R/W	LRESET#	1	0: GPIO86 outputs 0 when in output mode. 1: GPIO86 outputs 1 when in output mode.
5	GPIO85_VAL	R/W	LRESET#	1	0: GPIO85 outputs 0 when in output mode. 1: GPIO85 outputs 1 when in output mode.
4	GPIO84_VAL	R/W	LRESET#	1	0: GPIO84 outputs 0 when in output mode. 1: GPIO84 outputs 1 when in output mode.
3	GPIO83_VAL	R/W	LRESET#	1	0: GPIO83 outputs 0 when in output mode. 1: GPIO83 outputs 1 when in output mode.
2	GPIO82_VAL	R/W	LRESET#	1	0: GPIO82 outputs 0 when in output mode. 1: GPIO82 outputs 1 when in output mode.
1	GPIO81_VAL	R/W	LRESET#	1	0: GPIO81 outputs 0 when in output mode. 1: GPIO81 outputs 1 when in output mode.
0	GPIO80_VAL	R/W	LRESET#	1	0: GPIO80 outputs 0 when in output mode. 1: GPIO80 outputs 1 when in output mode.

8.7.14.1 GPIO8 Output Enable Register — Index 88h

Bit	Name	R/W	Reset	Default	Description
7	GPIO87_OE	R/W	LRESET#	1	0: GPIO87 is in input mode. 1: GPIO87 is in output mode.
6	GPIO86_OE	R/W	LRESET#	1	0: GPIO86 is in input mode. 1: GPIO85 is in output mode.
5	GPIO85_OE	R/W	LRESET#	1	0: GPIO85 is in input mode. 1: GPIO85 is in output mode.
4	GPIO84_OE	R/W	LRESET#	1	0: GPIO84 is in input mode. 1: GPIO84 is in output mode.
3	GPIO83_OE	R/W	LRESET#	1	0: GPIO83 is in input mode. 1: GPIO83 is in output mode.
2	GPIO82_OE	R/W	LRESET#	1	0: GPIO82 is in input mode. 1: GPIO82 is in output mode.
1	GPIO81_OE	R/W	LRESET#	1	0: GPIO81 is in input mode. 1: GPIO81 is in output mode.
0	GPIO80_OE	R/W	LRESET#	1	0: GPIO80 is in input mode. 1: GPIO80 is in output mode.

5.1.1.4 Sample Code in C Language

5.1.1.4.1 Control of GP70 to GP77 (DI1 ~ DI8)

```
#define AddrPort 0x4E
```

```
#define DataPort 0x4F
```

<Enter the Extended Function Mode>

```
WriteByte(AddrPort, 0x87)
```

```
WriteByte(AddrPort, 0x87) // Must write twice to enter Extended mode
```

<Select Logic Device>

```
WriteByte(AddrPort, 0x07)
```

```
WriteByte(dataPort, 0x06) // Select logic device 06h
```

<Output/Input Mode Selection> // Set GP70 to GP77 input Mode

```
WriteByte(AddrPort, 0x80) // Select configuration register 80h
```

```
WriteByte(DataPort, 0x0X) // Set (bit 0~7) = 0 to select GP 70~77 as Input mode.
```

<Input Value>

```
WriteByte(AddrPort, 0x82) // Select configuration register 82h
```

```
ReadByte(DataPort, Value) // Read bit 0~7 (0xFF)= GP70 ~77 as High.
```

<Leave the Extended Function Mode>

```
WriteByte(AddrPort, 0xAA)
```

5.1.1.4.2 Control of GP80 to GP87 (DO1 ~ DO8)

```
#define AddrPort 0x4E
#define DataPort 0x4F

<Enter the Extended Function Mode>
WriteByte(AddrPort, 0x87)
WriteByte(AddrPort, 0x87) // Must write twice to enter Extended mode

<Select Logic Device>
WriteByte(AddrPort, 0x07)
WriteByte(DataPort, 0x06) // Select logic device 06h

<Output/Input Mode Selection> // Set GP80 to GP87 output Mode
WriteByte(AddrPort, 0x88) // Select configuration register 88h
WriteByte(DataPort, 0xFF) // Set (bit 0~7) = 1 to select GP 80 ~87 as Output mode.

<Output Value>
WriteByte(AddrPort, 0x89) // Select configuration register 89h
WriteByte(DataPort, Value) // Set bit 0~7=(0/1) to output GP 80~87 as Low or High

<Leave the Extended Function Mode>
WriteByte(AddrPort, 0xAA)
```

5.1.1.5 Change base address

```
<Enter the Extended Function Mode>
WriteByte(AddrPort, 0x87)
WriteByte(AddrPort, 0x87) // Must write twice to enter Extended mode

<Select Logic Device>
WriteByte(AddrPort, 0x07)
WriteByte(dataPort, 0x06) // Select logic device 06h

WriteByte(AddrPort, 0x60) // Select configuration register 60h (High Byte address)
WriteByte(DataPort, (0x0A))

WriteByte(AddrPort, 0x61) // Select configuration register 61h (Low Byte address)
WriteByte(DataPort, (0x00))

<Leave the Extended Function Mode>
WriteByte(AddrPort, 0xAA)
```

Cincoze default GPIO Port base address is 0xA00h

5.1.1.6 DATA Bit Table (DIO)

<table border="1"> <tr><td>7</td><td>6</td><td>5</td><td>4</td><td>3</td><td>2</td><td>1</td><td>0</td><td>bit</td></tr> <tr><td>0</td><td>0</td><td>0</td><td>0</td><td>0</td><td>0</td><td>0</td><td>1</td><td>Value</td></tr> <tr><td colspan="8">1</td><td>/h</td></tr> </table>	7	6	5	4	3	2	1	0	bit	0	0	0	0	0	0	0	1	Value	1								/h	<p>= DI1 (Base address +3) (0xA03)</p>	<table border="1"> <tr><td>7</td><td>6</td><td>5</td><td>4</td><td>3</td><td>2</td><td>1</td><td>0</td><td>bit</td></tr> <tr><td>0</td><td>0</td><td>0</td><td>0</td><td>0</td><td>0</td><td>0</td><td>1</td><td>Value</td></tr> <tr><td colspan="8">1</td><td>/h</td></tr> </table>	7	6	5	4	3	2	1	0	bit	0	0	0	0	0	0	0	1	Value	1								/h	<p>= DO1 (Base address +2) (0xA02)</p>
7	6	5	4	3	2	1	0	bit																																																	
0	0	0	0	0	0	0	1	Value																																																	
1								/h																																																	
7	6	5	4	3	2	1	0	bit																																																	
0	0	0	0	0	0	0	1	Value																																																	
1								/h																																																	
<table border="1"> <tr><td>7</td><td>6</td><td>5</td><td>4</td><td>3</td><td>2</td><td>1</td><td>0</td><td>bit</td></tr> <tr><td>0</td><td>0</td><td>0</td><td>0</td><td>0</td><td>0</td><td>1</td><td>0</td><td>Value</td></tr> <tr><td colspan="8">2</td><td>/h</td></tr> </table>	7	6	5	4	3	2	1	0	bit	0	0	0	0	0	0	1	0	Value	2								/h	<p>= DI2 (Base address +3) (0xA03)</p>	<table border="1"> <tr><td>7</td><td>6</td><td>5</td><td>4</td><td>3</td><td>2</td><td>1</td><td>0</td><td>bit</td></tr> <tr><td>0</td><td>0</td><td>0</td><td>0</td><td>0</td><td>0</td><td>1</td><td>0</td><td>Value</td></tr> <tr><td colspan="8">2</td><td>/h</td></tr> </table>	7	6	5	4	3	2	1	0	bit	0	0	0	0	0	0	1	0	Value	2								/h	<p>= DO2 Base address +2) (0xA02)</p>
7	6	5	4	3	2	1	0	bit																																																	
0	0	0	0	0	0	1	0	Value																																																	
2								/h																																																	
7	6	5	4	3	2	1	0	bit																																																	
0	0	0	0	0	0	1	0	Value																																																	
2								/h																																																	
<table border="1"> <tr><td>7</td><td>6</td><td>5</td><td>4</td><td>3</td><td>2</td><td>1</td><td>0</td><td>bit</td></tr> <tr><td>0</td><td>0</td><td>0</td><td>0</td><td>0</td><td>1</td><td>0</td><td>0</td><td>Value</td></tr> <tr><td colspan="8">4</td><td>/h</td></tr> </table>	7	6	5	4	3	2	1	0	bit	0	0	0	0	0	1	0	0	Value	4								/h	<p>= DI3 (Base address +3) (0xA03)</p>	<table border="1"> <tr><td>7</td><td>6</td><td>5</td><td>4</td><td>3</td><td>2</td><td>1</td><td>0</td><td>bit</td></tr> <tr><td>0</td><td>0</td><td>0</td><td>0</td><td>0</td><td>1</td><td>0</td><td>0</td><td>Value</td></tr> <tr><td colspan="8">4</td><td>/h</td></tr> </table>	7	6	5	4	3	2	1	0	bit	0	0	0	0	0	1	0	0	Value	4								/h	<p>= DO3 Base address +2) (0xA02)</p>
7	6	5	4	3	2	1	0	bit																																																	
0	0	0	0	0	1	0	0	Value																																																	
4								/h																																																	
7	6	5	4	3	2	1	0	bit																																																	
0	0	0	0	0	1	0	0	Value																																																	
4								/h																																																	
<table border="1"> <tr><td>7</td><td>6</td><td>5</td><td>4</td><td>3</td><td>2</td><td>1</td><td>0</td><td>bit</td></tr> <tr><td>0</td><td>0</td><td>0</td><td>0</td><td>1</td><td>0</td><td>0</td><td>0</td><td>Value</td></tr> <tr><td colspan="8">8</td><td>/h</td></tr> </table>	7	6	5	4	3	2	1	0	bit	0	0	0	0	1	0	0	0	Value	8								/h	<p>= DI4 (Base address +3) (0xA03)</p>	<table border="1"> <tr><td>7</td><td>6</td><td>5</td><td>4</td><td>3</td><td>2</td><td>1</td><td>0</td><td>bit</td></tr> <tr><td>0</td><td>0</td><td>0</td><td>0</td><td>1</td><td>0</td><td>0</td><td>0</td><td>Value</td></tr> <tr><td colspan="8">8</td><td>/h</td></tr> </table>	7	6	5	4	3	2	1	0	bit	0	0	0	0	1	0	0	0	Value	8								/h	<p>= DO4 Base address +2) (0xA02)</p>
7	6	5	4	3	2	1	0	bit																																																	
0	0	0	0	1	0	0	0	Value																																																	
8								/h																																																	
7	6	5	4	3	2	1	0	bit																																																	
0	0	0	0	1	0	0	0	Value																																																	
8								/h																																																	
<table border="1"> <tr><td>7</td><td>6</td><td>5</td><td>4</td><td>3</td><td>2</td><td>1</td><td>0</td><td>bit</td></tr> <tr><td>0</td><td>0</td><td>0</td><td>1</td><td>0</td><td>0</td><td>0</td><td>0</td><td>Value</td></tr> <tr><td colspan="8">10</td><td>/h</td></tr> </table>	7	6	5	4	3	2	1	0	bit	0	0	0	1	0	0	0	0	Value	10								/h	<p>= DI5 (Base address +3) (0xA03)</p>	<table border="1"> <tr><td>7</td><td>6</td><td>5</td><td>4</td><td>3</td><td>2</td><td>1</td><td>0</td><td>bit</td></tr> <tr><td>0</td><td>0</td><td>0</td><td>1</td><td>0</td><td>0</td><td>0</td><td>0</td><td>Value</td></tr> <tr><td colspan="8">10</td><td>/h</td></tr> </table>	7	6	5	4	3	2	1	0	bit	0	0	0	1	0	0	0	0	Value	10								/h	<p>= DO5 Base address +2) (0xA02)</p>
7	6	5	4	3	2	1	0	bit																																																	
0	0	0	1	0	0	0	0	Value																																																	
10								/h																																																	
7	6	5	4	3	2	1	0	bit																																																	
0	0	0	1	0	0	0	0	Value																																																	
10								/h																																																	
<table border="1"> <tr><td>7</td><td>6</td><td>5</td><td>4</td><td>3</td><td>2</td><td>1</td><td>0</td><td>bit</td></tr> <tr><td>0</td><td>0</td><td>1</td><td>0</td><td>0</td><td>0</td><td>0</td><td>0</td><td>Value</td></tr> <tr><td colspan="8">20</td><td>/h</td></tr> </table>	7	6	5	4	3	2	1	0	bit	0	0	1	0	0	0	0	0	Value	20								/h	<p>= DI6 (Base address +3) (0xA03)</p>	<table border="1"> <tr><td>7</td><td>6</td><td>5</td><td>4</td><td>3</td><td>2</td><td>1</td><td>0</td><td>bit</td></tr> <tr><td>0</td><td>0</td><td>1</td><td>0</td><td>0</td><td>0</td><td>0</td><td>0</td><td>Value</td></tr> <tr><td colspan="8">20</td><td>/h</td></tr> </table>	7	6	5	4	3	2	1	0	bit	0	0	1	0	0	0	0	0	Value	20								/h	<p>= DO6 Base address +2) (0xA02)</p>
7	6	5	4	3	2	1	0	bit																																																	
0	0	1	0	0	0	0	0	Value																																																	
20								/h																																																	
7	6	5	4	3	2	1	0	bit																																																	
0	0	1	0	0	0	0	0	Value																																																	
20								/h																																																	
<table border="1"> <tr><td>7</td><td>6</td><td>5</td><td>4</td><td>3</td><td>2</td><td>1</td><td>0</td><td>bit</td></tr> <tr><td>0</td><td>1</td><td>0</td><td>0</td><td>0</td><td>0</td><td>0</td><td>0</td><td>Value</td></tr> <tr><td colspan="8">40</td><td>/h</td></tr> </table>	7	6	5	4	3	2	1	0	bit	0	1	0	0	0	0	0	0	Value	40								/h	<p>= DI7 (Base address +3) (0xA03)</p>	<table border="1"> <tr><td>7</td><td>6</td><td>5</td><td>4</td><td>3</td><td>2</td><td>1</td><td>0</td><td>bit</td></tr> <tr><td>0</td><td>1</td><td>0</td><td>0</td><td>0</td><td>0</td><td>0</td><td>0</td><td>Value</td></tr> <tr><td colspan="8">40</td><td>/h</td></tr> </table>	7	6	5	4	3	2	1	0	bit	0	1	0	0	0	0	0	0	Value	40								/h	<p>= DO7 Base address +2) (0xA02)</p>
7	6	5	4	3	2	1	0	bit																																																	
0	1	0	0	0	0	0	0	Value																																																	
40								/h																																																	
7	6	5	4	3	2	1	0	bit																																																	
0	1	0	0	0	0	0	0	Value																																																	
40								/h																																																	
<table border="1"> <tr><td>7</td><td>6</td><td>5</td><td>4</td><td>3</td><td>2</td><td>1</td><td>0</td><td>bit</td></tr> <tr><td>1</td><td>0</td><td>0</td><td>0</td><td>0</td><td>0</td><td>0</td><td>0</td><td>Value</td></tr> <tr><td colspan="8">80</td><td>/h</td></tr> </table>	7	6	5	4	3	2	1	0	bit	1	0	0	0	0	0	0	0	Value	80								/h	<p>= DI8 (Base address +3) (0xA03)</p>	<table border="1"> <tr><td>7</td><td>6</td><td>5</td><td>4</td><td>3</td><td>2</td><td>1</td><td>0</td><td>bit</td></tr> <tr><td>1</td><td>0</td><td>0</td><td>0</td><td>0</td><td>0</td><td>0</td><td>0</td><td>Value</td></tr> <tr><td colspan="8">80</td><td>/h</td></tr> </table>	7	6	5	4	3	2	1	0	bit	1	0	0	0	0	0	0	0	Value	80								/h	<p>= DO8 Base address +2) (0xA02)</p>
7	6	5	4	3	2	1	0	bit																																																	
1	0	0	0	0	0	0	0	Value																																																	
80								/h																																																	
7	6	5	4	3	2	1	0	bit																																																	
1	0	0	0	0	0	0	0	Value																																																	
80								/h																																																	

5.1.1.7 DIO I/O Port Address (Default Address 0xA00)

DI8	DI7	DI6	DI5	DI4	DI3	DI2	DI1	DO8	DO7	DO6	DO5	DO4	DO3	DO2	DO1	Pin Definition
7	6	5	4	3	2	1	0	7	6	5	4	3	2	1	0	Data Bits
DI								DO								DIO
0xA03								0xA02								I/O Port address

5.2 DIO Hardware Specification

- XCOM+: Isolated power in V+
- XCOM-: Isolated power in V-
- Isolated power in DC voltage: 9~30V
- 8x Digital Input (Source Type)
- Input Signal Voltage Level
 - Signal Logic 0: XCOM+ = 9V, $\text{Signal Low} - V_- < 1V$
 $\text{XCOM+} > 9V, V_+ - \text{Signal Low} > 8V$
 - Signal Logic 1: $> \text{XCOM+} - 3V$
- Input Driving Sink Current:
 - Minimal: 1 mA
 - Normal: 5 mA
- 8x Digital Output (Open Drain)
 - DO Signal have to pull up resistor to XCOM+ for external device, the resistance will affect the pull up current
 - Signal High Level: Pull up resistor to XCOM+
 - Signal Low Level: = XCOM-
 - Sink Current: 1A (Max)

5.2.1 DIO Connector Definition

DIO1/DIO2: Digital Input / Output Connector

Connector Type: Terminal Block 2X10 10-pin, 3.5mm pitch

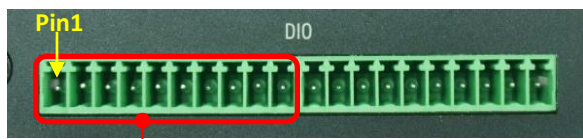

DIO1 (Digital Input)

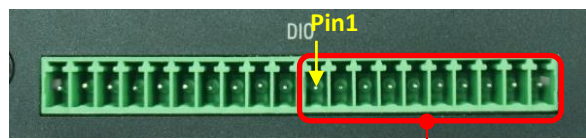

DIO2 (Digital Input)

Location	Pin	Definition
DIO1	1	DC INPUT (XCOM+)
	2	DI1
	3	DI2
	4	DI3
	5	DI4
	6	DI5
	7	DI6
	8	DI7
	9	DI8
	10	GND (XCOM-)

Location	Pin	Definition
DIO2	1	DC INPUT (XCOM+)
	2	DO1
	3	DO2
	4	DO3
	5	DO4
	6	DO5
	7	DO6
	8	DO7
	9	DO8
	10	GND (XCOM-)

Reference Input Circuit

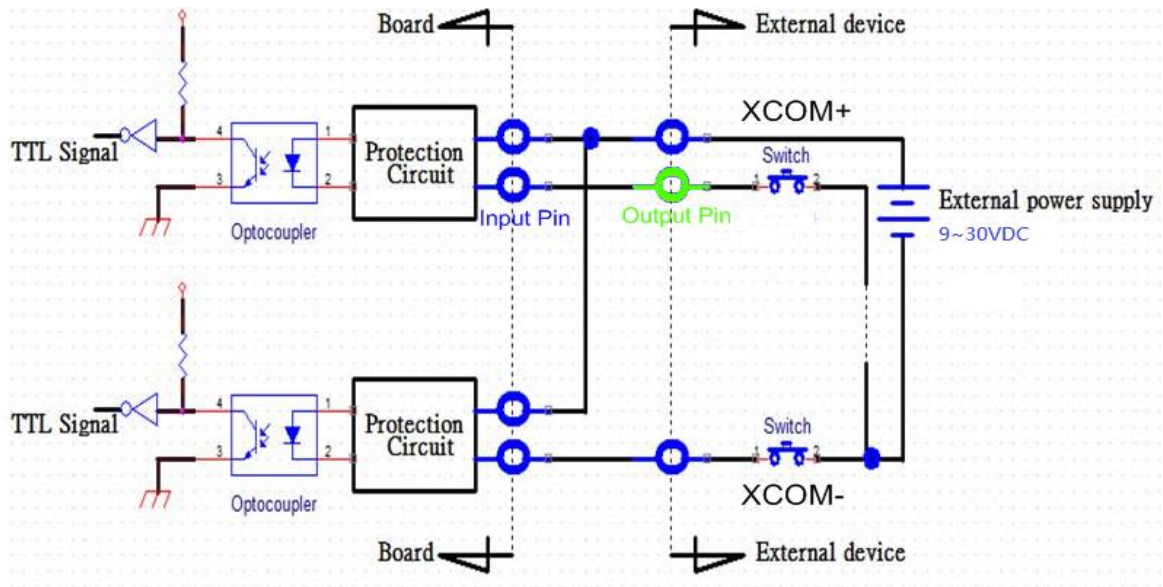

Reference Output Circuit

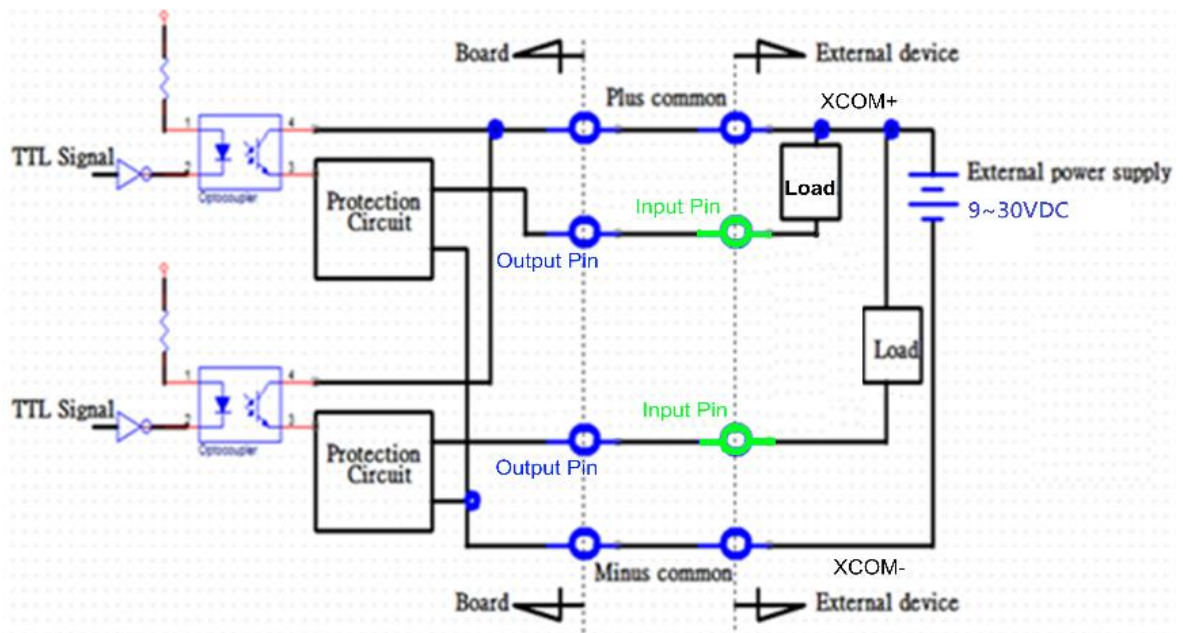



Chapter 6

Optional Modules

Pin Definitions and Settings

6.1 Location of the Connectors and Switches

Model No.	Product Description
CFM-IGN01	CFM Module with Power Ignition Sensing Control Function, Select 12V/24V
CMI-COM01/UB0903	CMI Module with 2x RS232/422/485, 1x Universal Bracket
CMI-DIO01/UB0918	CMI Module with 16x Optical Isolated DIO (8 in/8 out), 1x Universal Bracket

6.2 CFM-IGN Connector Definition and Settings

SW2: IGN Function Switch

Set shutdown delay timer when ACC is turned off

Pin 1	Pin 2	Pin 3	Pin 4	Definition
ON	ON	ON	ON / OFF	0 second
ON	ON	OFF		1 minute
ON	OFF	ON		5 minutes
ON	OFF	OFF		10 minutes
OFF	ON	ON		30 minutes
OFF	ON	OFF		1 hour
OFF	OFF	ON		2 hours
OFF	OFF	OFF		Reserved (0 second)

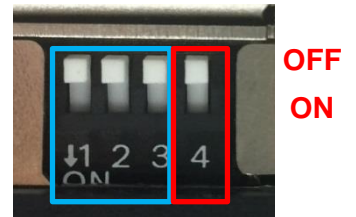

24V_12V_1: 12V / 24V Car Battery Switch

Pin	Definition
1-2	24V Car Battery Input
2-3	12V Car Battery Input

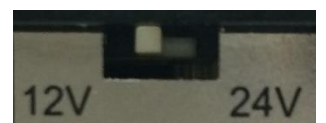

6.3 CMI-COM Connector Definition and Settings

COM5 / COM6: RS232 / RS422 / RS485 Connector

Connector Type: 9-pin D-Sub

Pin	RS232 Definition	RS422 / 485 Full Duplex Definition	RS485 Half Duplex Definition
1	DCD	TX-	DATA -
2	RXD	TX+	DATA +
3	TXD	RX+	
4	DTR	RX-	
5	GND		
6	DSR		
7	RTS		
8	CTS		
9	RI		

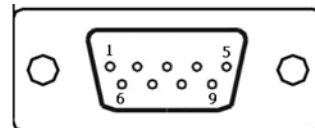

SW2: COM5/COM6 Power Select

Location	Function	DIP1	DIP2
SW2	0V(RI)	ON (Default)	ON (Default)
	5V	ON	OFF
	12V	OFF	OFF

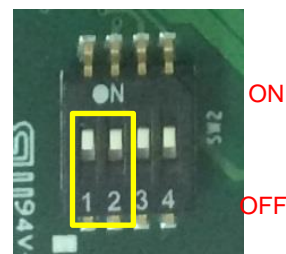

Location	Function	DIP3	DIP4
SW2	0V(RI)	ON (Default)	ON (Default)
	5V	ON	OFF
	12V	OFF	OFF

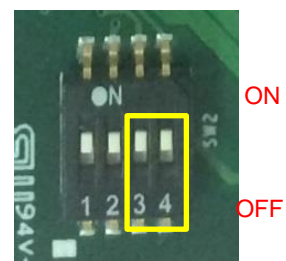

6.4 CMI-M12 LAN Module Pin Definitions

CMI-M12 LAN Module Pin Definitions

Connector Type: M12 A coded 8pin connector

Pin	Definition	Pin	Definition
1	2_LAN1_0+	2	2_LAN1_0-
3	2_LAN1_1+	4	2_LAN1_2+
5	2_LAN1_2-	6	2_LAN1_1-
7	2_LAN1_3+	8	2_LAN1_3-

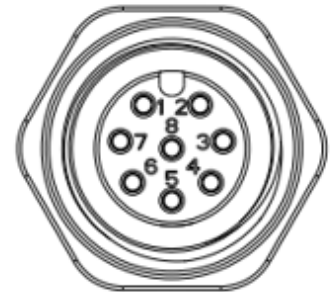

CMI-M12 LAN Module with CFM-PoE Module Pin Definitions

Connector Type: M12 A coded 8pin connector POE type: Midspan (B-Type)

Pin	Definition	Pin	Definition
1	2_LAN1_0+	2	2_LAN1_0-
3	2_LAN1_1+	4	2_LAN1_2+ (Power PIN)
5	2_LAN1_2- (Power PIN)	6	2_LAN1_1-
7	2_LAN1_3+ (Power PIN)	8	2_LAN1_3- (Power PIN)

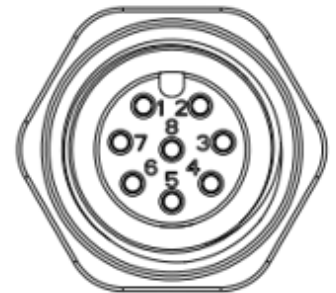

cincoze

© 2020 Cincoze Co., Ltd. All rights reserved.

The Cincoze logo is a registered trademark of Cincoze Co., Ltd.

All other logos appearing in this catalog are the intellectual property of the respective company, product, or organization associated with the logo.

All product specifications and information are subject to change without notice.