

PBC-1000 USER

Intel Atom® x6211E (Elkhart Lake) Fanless Embedded System,
Ultra-Compact, Rugged, -40°C to 70°C Operation Temperature

Manual

Record of Revision

Version	Date	Page	Description	Remark
1.00	2022/05/20	All	Official Release	

Disclaimer

This manual is released by Vecow Co., Ltd. for reference purpose only. All product offerings and specifications are subject to change without prior notice. It does not represent commitment of Vecow Co., Ltd. Vecow shall not be liable for direct, indirect, special, incidental, or consequential damages arising out of the use of the product or documentation or any infringements upon the rights of third parties, which may result from such use.

Declaration of Conformity

FCC This equipment has been tested and found to comply with the limits for a Class A digital device, pursuant to part 15 of the FCC Rules. These limits are designed to provide reasonable protection against harmful interference when the equipment is operated in a commercial environment. This equipment generates, uses, and can radiate radio frequency energy, and if it is not installed and used in accordance with the instruction manual, it may cause harmful interference to radio communications. Operation of this equipment in a residential area is likely to cause harmful interference in which case the user will be required to correct the interference at his own expense.

CE The products described in this manual complies with all applicable European Union (CE) directives if it has a CE marking. For computer systems to remain CE compliant, only CE-compliant parts may be used. Maintaining CE compliance also requires proper cable and cabling techniques.

Copyright and Trademarks

This document contains proprietary information protected by copyright. No part of this publication may be reproduced in any form or by any means, electric, photocopying, recording or otherwise, without prior written authorization by Vecow Co., Ltd. The rights of all the brand names, product names, and trademarks belong to their respective owners.

Order Information

Model	GigE LAN	USB 3.0	COM	DisplayPort	SIM Socket
PBC-1000	2	2	2	1	1

Order Accessories

Part Number	Description
DDR4 32G	Certified DDR4 32GB 3200MHz RAM
DDR4 16G	Certified DDR4 16GB 3200MHz RAM
DDR4 8G	Certified DDR4 8GB 3200MHz RAM
DDR4 4G	Certified DDR4 4GB 3200MHz RAM
PWA-60W-12V	60W, 12V, 90V AC to 264V AC Power Adapter with 2-pin Terminal Block
DIN-RAIL	DIN Rail Mounting Kit
5G Module	5G Module with Antenna
4G Module	4G/GPS Module with Antenna
WiFi & Bluetooth	WiFi & Bluetooth Module with Antenna

Table of Contents

CHAPTER 1	GENERAL INTRODUCTION	1
	1.1 Overview	1
	1.2 Features	2
	1.3 Product Specification	3
	1.3.1 Specifications of PBC-1000	3
	1.4 Mechanical Dimension	4
CHAPTER 2	GETTING TO KNOW YOUR PBC-1000	5
	2.1 Packing List	5
	2.2 Front Panel I/O & Functions	6
	2.3 Rear Panel I/O & Functions	10
	2.4 Main Board Expansion Connectors	11
	2.5 Main Board Jumper Settings	22
CHAPTER 3	SETUP	24
	3.1 How to Open Your PBC-1000	24
	3.2 Installing DDR4 SO-DIMM Modules	25
	3.3 Installing SIM Card	26
	3.4 Installing SSD/HDD	26
	3.5 Installing M.2	28
	3.6 Installing Antenna cable	29
	3.7 Mounting Your PBC-1000	30

CHAPTER 4	BIOS SETUP	31
4.1	BIOS Setup	31
4.2	Main Menu	32
4.3	Advanced Functions	33
4.4	Chipset Functions	41
4.5	Security Function	46
4.6	Boot Function	48
4.7	Save & Exit	49
APPENDIX A	: GPIO Guide	50
APPENDIX B	: Software Functions	53
APPENDIX C	: Power Consumption	56
APPENDIX D	: Supported Memory & Storage List	58
APPENDIX E	: Driver install (Unknown Device)	60

1

GENERAL INTRODUCTION

1.1 Overview

Vecow PBC-1000 is an Ultra-Compact Fanless Embedded Box PC. Powered by Intel Atom® x6000E Series processor, Vecow PBC-1000 brings power-efficient, enhanced graphics performance and flexibility capabilities to empower the edge applications such as Intelligent Control, Energy Management, M2M, In-Vehicle Infotainment, factory Automation, and any AIoT/Industry 4.0 applications.

Vecow PBC-1000 is based on Intel Atom® x6000E Series Processor to deliver up to 40% faster computing and two times improved 3D graphics performance than the former generation solution. Equipped with 2 GigE LAN, 1 DisplayPort with 4K resolution, 32GB of DDR4-3200MHz SO-DIMM memory, M.2 slot for expansions and SATA storage, Vecow PBC-1000 provides an uncompromised visual experience, enhanced I/O and storage options for AIoT applications.

Vecow PBC-1000 features fanless with small form factor design and supports -40°C to 70°C operating temperature and 12V DC power input, making it perfect solution for Intelligent Control, Energy Management, M2M or Industry 4.0 and AIoT applications.

1.2 Features

- Intel Atom® x6000 Series Processor delivers up to 40% faster compute and up to 2X better 3D graphics performance than the former generation solution 2.5" Pico-ITX compact size, Small Form Factor (SFF), measure only 100 x 72 mm
- Small form factor, ultra-compact design
- Fanless, -40°C to 70°C Operating Temperature
- 2 GigE LAN, 2 USB 3.0, 2 COM, M.2 Key B, M.2 Key E
- SIM Socket for WiFi/5G/4G/LTE/GPRS/UMTS
- Optional VHub AIoT Solution Service supports OpenVINO based AI accelerator and advanced Edge AI applications

1.3 Product Specification

1.3.1 Specifications of PBC-1000

System	
Processor	Intel Atom® x6211E Processor (Elkhart Lake)
BIOS	AMI
SIO	IT8786E
Memory	1 DDR4 3200MHz SO-DIMM, up to 32GB
OS	Windows 10, Linux
Graphics	
Processor	Intel® UHD Graphics for 10th Gen Intel® Processors
Interface	DisplayPort : Up to 4096 x 2160 @60Hz
Ethernet	
LAN 1	Realtek RTL8119I supports GigE LAN
LAN 2	Realtek RTL8119I supports GigE LAN
Audio	
Audio Codec	Realtek ALC888S-VD, 7.1 Channel HD Audio
I/O Interface	
Serial	<ul style="list-style-type: none">• 1 COM RS-232/422/485• 1 COM RS-232
USB	2 USB 3.0
LED	HDD, WLAN, Power, WWAN
SIM	1 External Nano SIM Card Socket
Storage	
SATA	1 SATA III (6Gbps)
Expansion	
M2	<ul style="list-style-type: none">• 1 M.2 Key B Socket (2280)• 1 M.2 Key E Socket (2230)
Power	
Power Input	12V DC-in
Power Interface	2-pin Terminal Block : V+, V-
Others	
Watchdog Timer	Reset : 1 to 255 sec./min. per step
HW Monitor	Monitoring temperature, voltages. Auto throttling control when CPU overheats.

Mechanical	
Dimension	126.0mm x 43.5mm x 78.5mm (4.96" x 1.74" x 3.09")
Weight	0.5 kg (1.1 lb)
Mounting	<ul style="list-style-type: none"> • Wallmount by mounting bracket • DIN Rail mount (Optional)
Environment	
Operating Temperature	-40°C to 70°C (-40°F to 158°F)
Storage Temperature	-40°C to 85°C (-40°F to 185°F)
Humidity	5% to 95% Humidity, non-condensing
Relative Humidity	95% at 70°C
Shock	<ul style="list-style-type: none"> • IEC 60068-2-27 • SSD : 50G @wallmount, Half-sine, 11ms
Vibration	<ul style="list-style-type: none"> • IEC 60068-2-64 • SSD : 5Grms, 5Hz to 500Hz, 3 Axis
EMC	CE, FCC, EN50155, EN50121-3-2

1.4 Mechanical Dimension

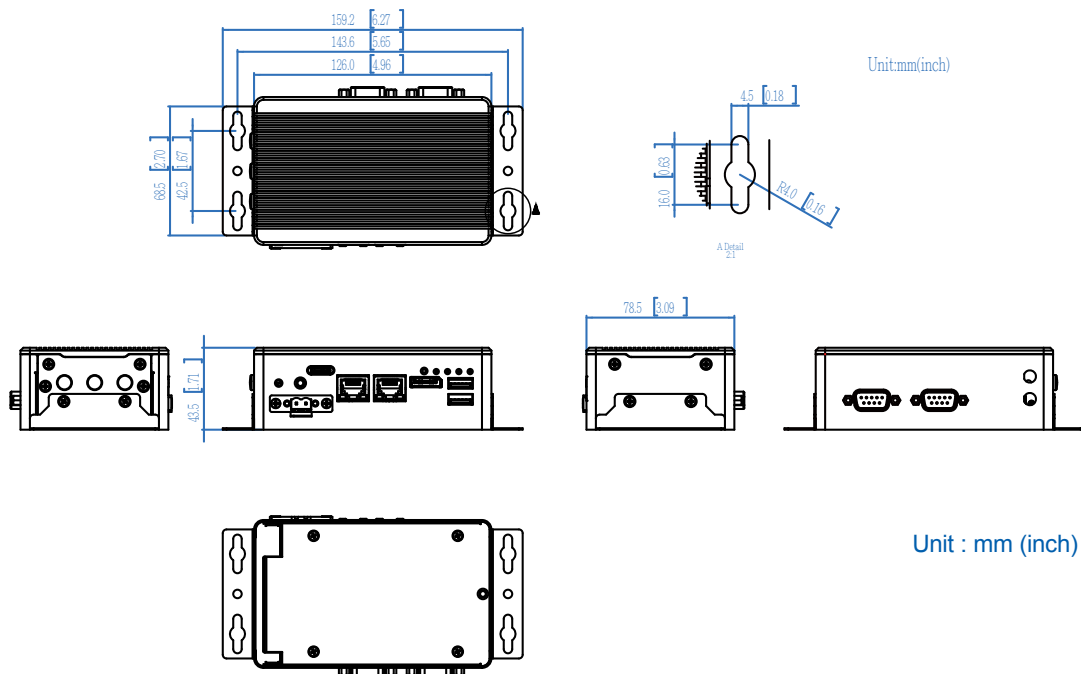







2

GETTING TO KNOW YOUR PBC-1000

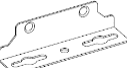
2.1 Packing List

Item	Description	Qty
1	PBC-1000 Embedded System	1
2	Driver/User Manual DVD	1

Item	Description	Picture	Use for	P/N	Qty
1	PHILLPIS M3*4L		M.2	53-2426204-80B	3
2	M3x4L		Wall mount Bracket/HDD	53-2466204-30B	8
3	Terminal block 2-pin (5.0mm)		DC-IN	51-2411R02-S1C	1
4	Wall Mount		Mount	62-01P0727-B00	2
5	M.2 Bracket		M.2	62-03P0997-30A	1
6	SATA Power Cable		HDD	61-1470022-005	1
7	SATA Data Cable		HDD	61-13B0707-3BA	1

2.2 Front Panel I/O & Functions

In Vecow's PBC-1000 series family, all I/O connectors are located on the front panel. Most of the general connections to the computer device, such as DC power input, SIM slot, Display port, USB3.2 and LAN Jack are placed on the front panel.

2.2.1 Power Terminal Block

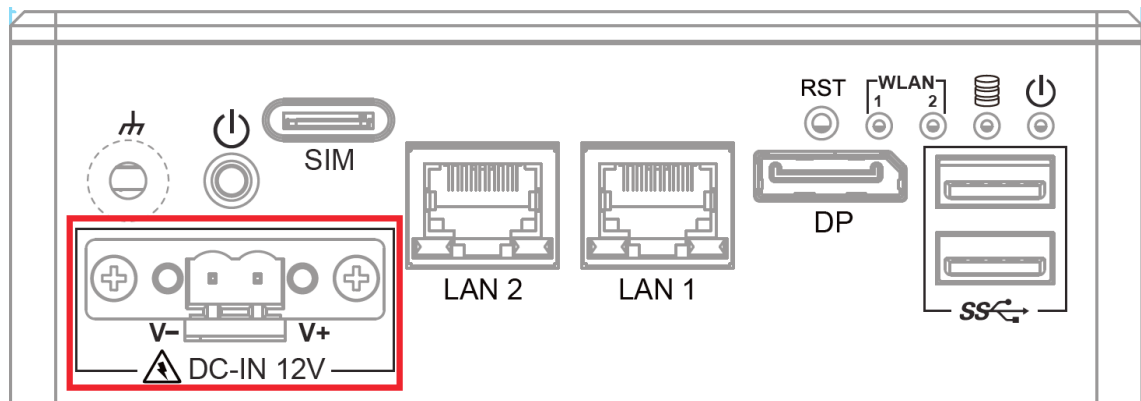

This system supports 12V only DC power input by terminal block in the rear side

2.2.2 Reset Tact Switch

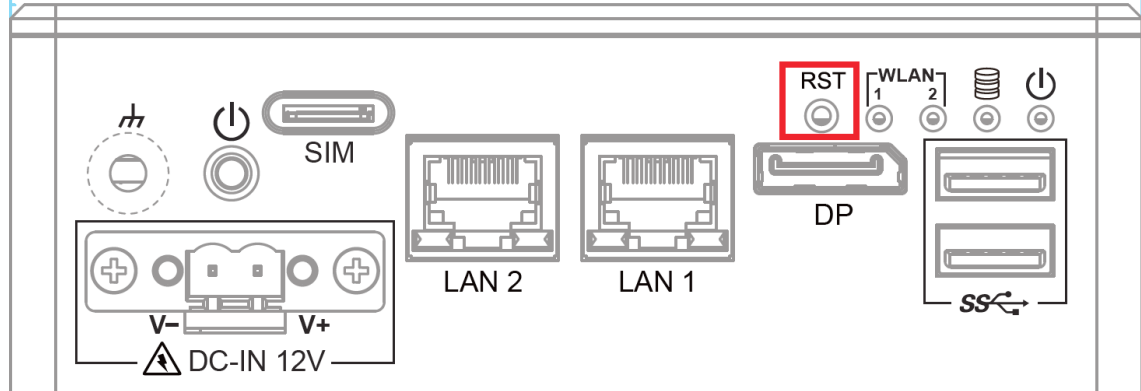

It is a hardware reset switch. Use this switch to reset the system without power off the system. Press the Reset Switch for a few seconds, and then reset will be enabled.

2.2.3 Power Button

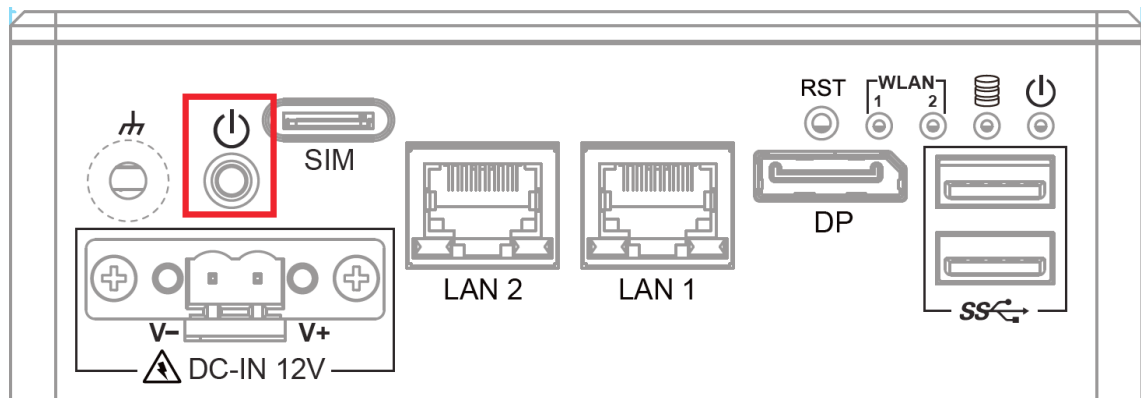

The power button is a non-latched switch. To power on PBC-1000, press the power button. To power off PBC-1000, you can either command shutdown by OS operation or simply press the power button. If system error appears, press and hold the power button for four seconds to shut down the machine directly. Please do note that a four-second interval between each two power-on/power-off operation is necessary in normal working status. (For example, once turning off the system, you have to wait for four seconds to initiate another power-on operation)

2.2.4 HDD,PWR,WLAN LED Indicator

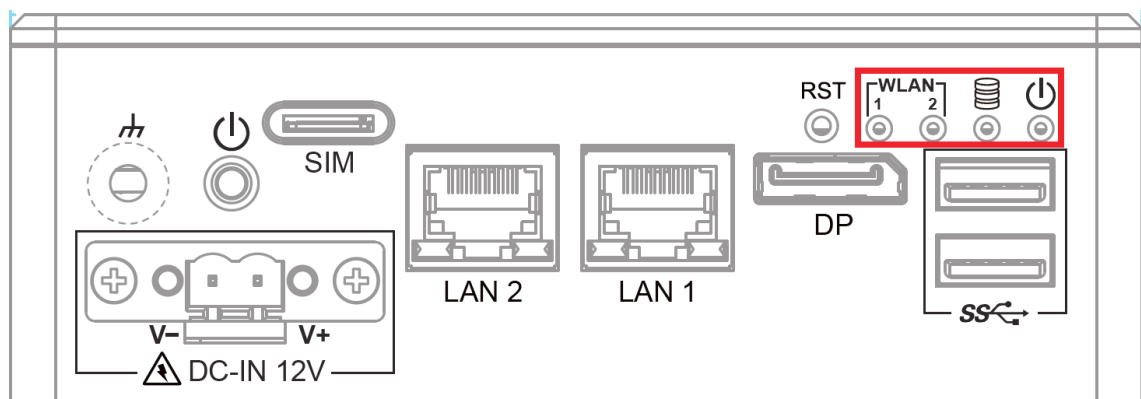

Green-WLAN_LED1 : If the LED is solid green, it indicates that the device on M2 key-E Socket is working.

Green-WLAN_LED2 : If the LED is solid green, it indicates that the device on M2 key-B Socket is working.

Orange-HDD LED : A hard disk LED. If the LED is on, it indicates that the system's storage is functional. If it is off, it indicates that the system's storage is not functional. If it is flashing, it indicates data access activities are in progress.

Green-Power LED : If the LED is solid green, it indicates that the system is powered on

2.2.5 USB 3.2 Gen1

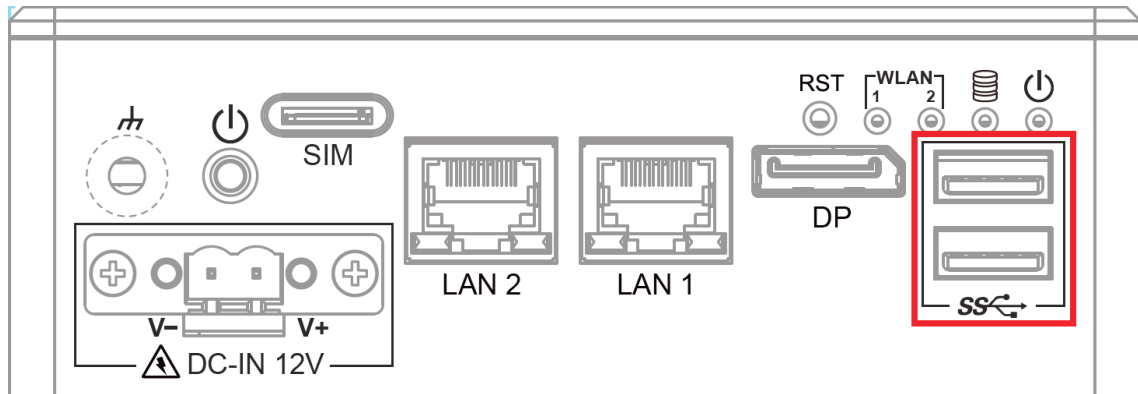

There are 2 USB 3.2 Gen1 connections available supporting up to 5GB per second data rate in the front side of PBC-1000. It is also compliant with the requirements of Super Speed (SS), high speed (HS), full speed (FS) and low speed (LS).

2.2.6 10/100/1000 Mbps Ethernet Port

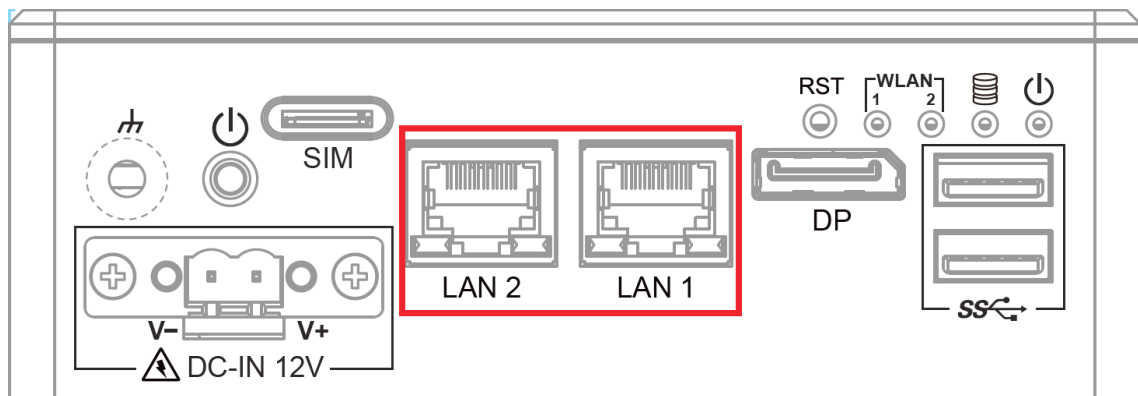

There are two 8-pin RJ-45 jacks supporting 10/100/1000 Mbps Ethernet connections in the top side. Which is powered by Realtek RTL8119I Ethernet engine. When both of LANs work in normal status, iAMT function is enabled. Using suitable RJ-45 cable, you can connect the system to a computer, or to any other devices with Ethernet connection, for example, a hub or a switch. Moreover, both of LANs support Wake on LAN and Pre-boot functions. The pin-outs of LAN 1 and LAN 2 are listed as follows :

Pin No.	10/100 Mbps	1000 Mbps
1	E_TX+	MDI0_P
2	E_TX-	MDI0_N
3	E_RX+	MDI1_P
4	-----	MDI1_N
5	-----	MDI2_P
6	E_RX-	MDI2_N
7	-----	MDI3_P
8	-----	MDI3_N

LED Location	LED Color	100Mbps	1000Mbps
Right	Green/ Orange	Off	Solid Green
Left	Orange	Twinkling Orange	Twinkling Orange

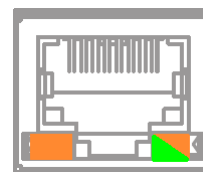

Each LAN port is supported by standard RJ-45 connector with LED indicators to present Active/Link/Speed status of the connection. The LED indicator on the left side lightens in solid green when the cable is properly connected to a 100Mbps Ethernet network; The LED indicator on the left side lightens in solid Orange when the cable is properly connected to a 1000Mbps Ethernet network; The left LED will keep twinkling/off when Ethernet data packets are being transmitted/receive

2.2.7 Display Port

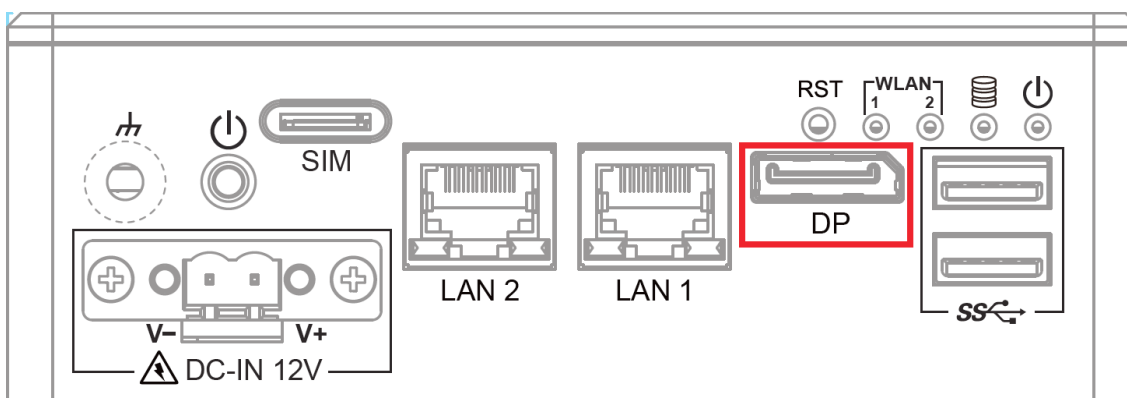

Display Port connection supports up to 4096 x 2160 resolution at 60Hz

2.2.8 Nano SIM Card Socket for M.2 key B Slot

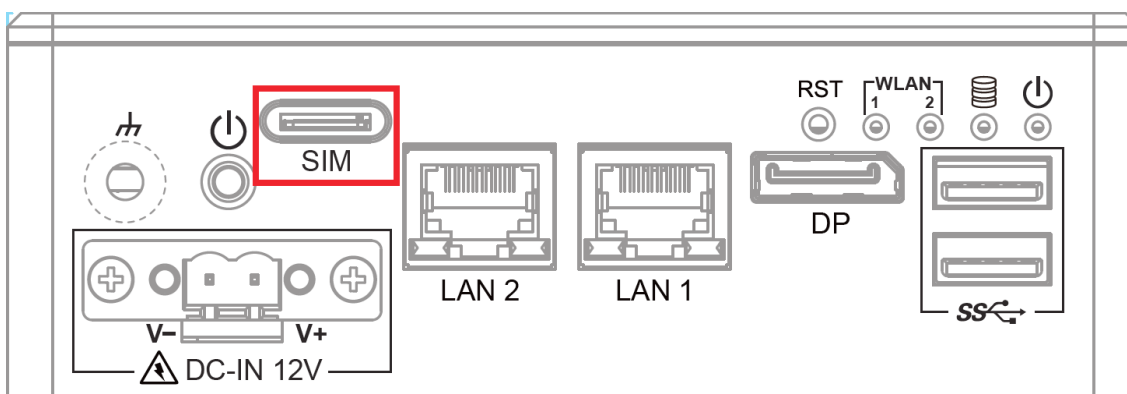

The Nano SIM card socket is support Push-Push type. Please make sure to unplug the system power before inserting the Nano SIM card.

2.3 Rear Panel I/O & Functions

2.3.1 Serial Port COM

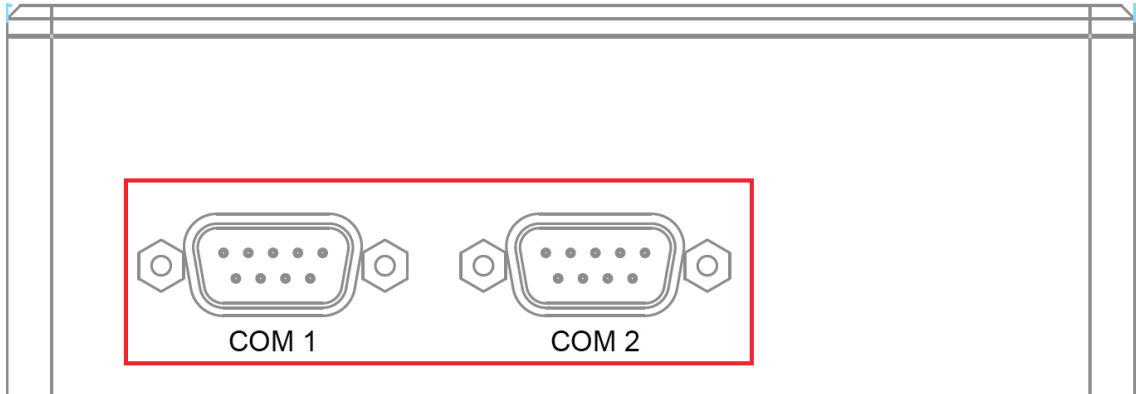

COM1 can be configured for RS-232, RS-422, or RS-485 with auto flow control communication, The default definition is RS-232. COM2 is support RS232 only, if you want to change to RS-422 or RS-485, you can find the setting in BIOS. The pin assignments are listed in the following table:

BIOS Setting	Function
COM1	RS-232
	RS-422 (5-wire)
	RS-485
	RS-485 w/z auto-flow control

2.4 Main Board Expansion Connectors

2.4.1 PBC-1000 Main Board Top Side View

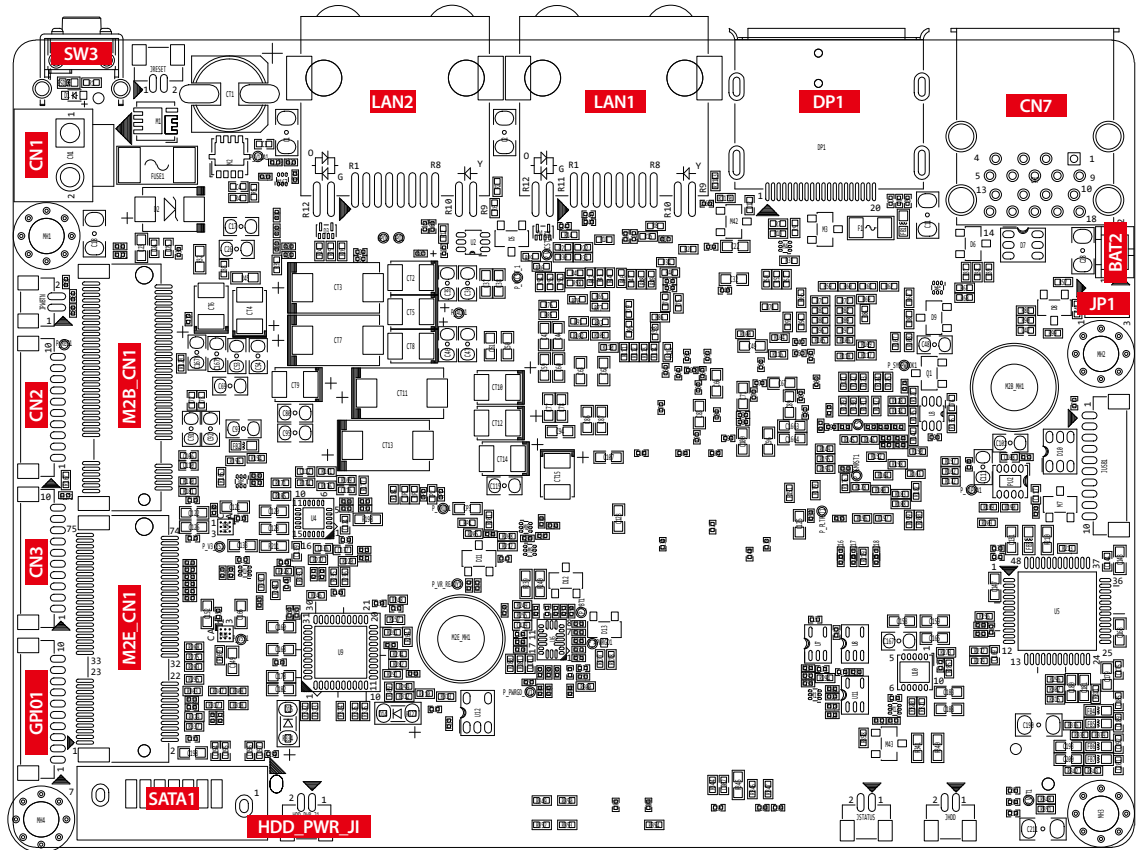

2.4.2 PBC-1000 Main Board Bot Side View

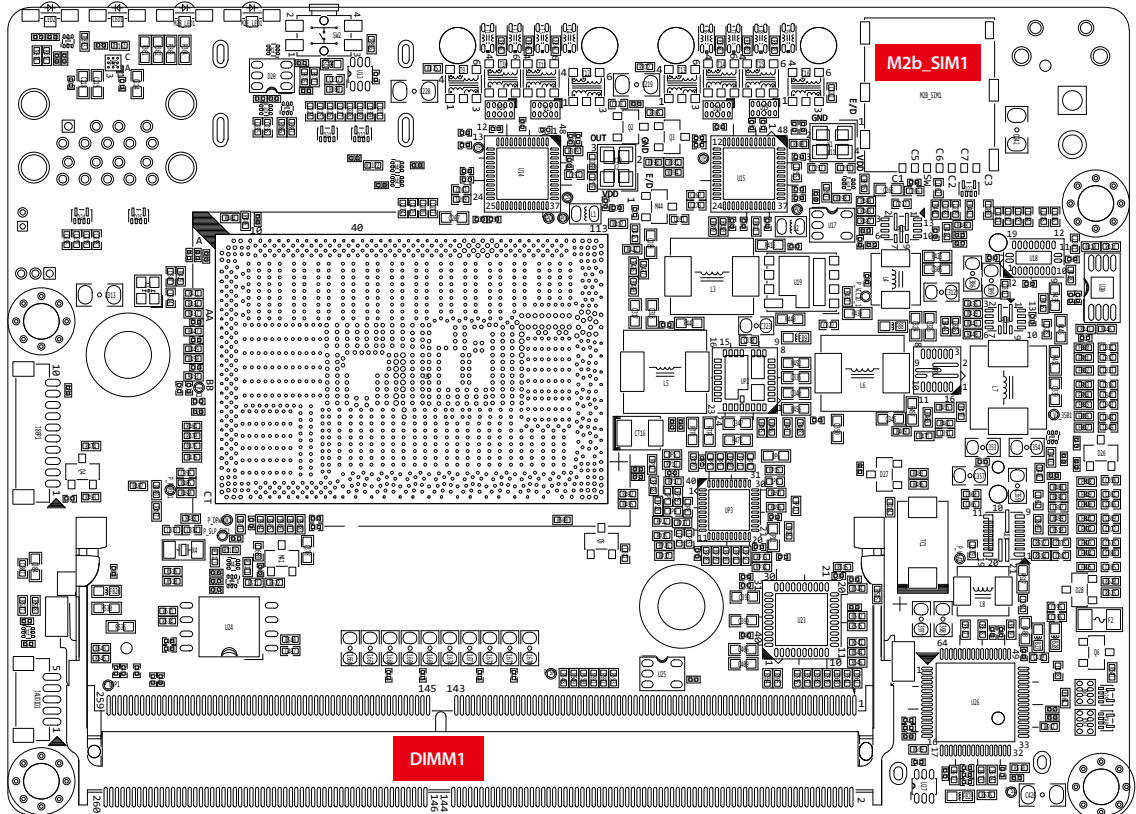

2.4.3 BAT2 : Battery

The PBC-1000 real-time clock is powered by a lithium battery. It is equipped with Panasonic BR2032 190mAh lithium battery. It is recommended that you not replace the lithium battery on your own, but if the battery needs to be changed, please contact the Vecow RMA service team.

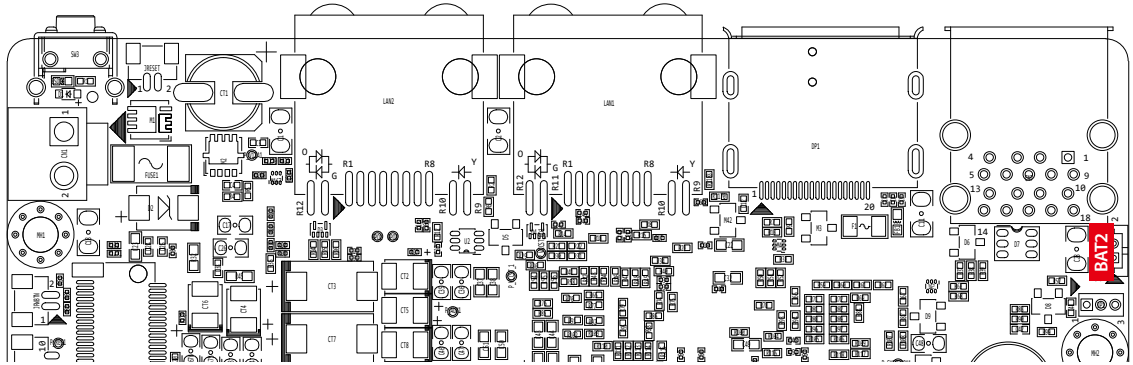

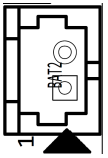
	Pin No.	Function
	1	+3V_BAT
	2	GND

2.4.4 DIMM1 : DDR4 Slot

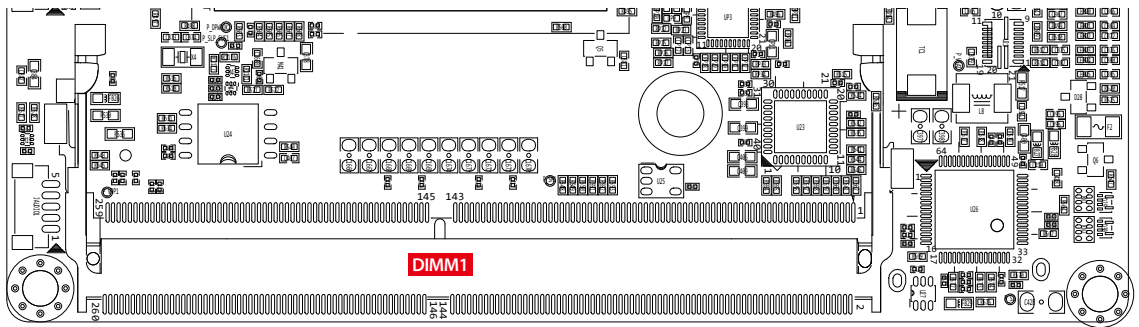

There is a DDR4 channel onboard, support DDR4 3200, max 32GB

2.4.5 M2E_CN1 : M.2 key E Slot for USB 2.0, PCIe Gen3x1 support

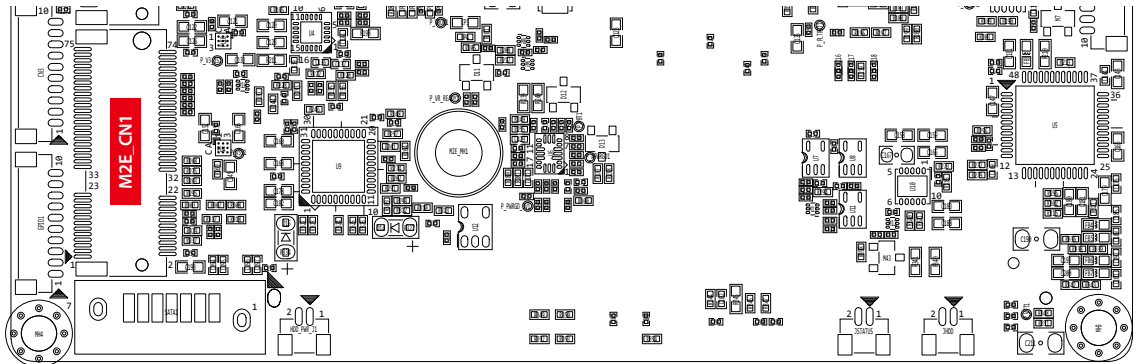

M.2 key E connector is suitable for applications that use wireless connectivity including Wi-Fi, Bluetooth, NFC or GNSS. Module card types include 2230. The pin assignments of M2E_CN1 are listed in the following table :

Pin No.	Signal Name	Pin No.	Signal Name
74	3.3V	75	GND
72	3.3V	73	NC
70	NC	71	NC
68	NC	69	GND
66	NC	67	NC
64	NC	65	NC
62	ALERT# (O)(0/3.3V)	63	GND
60	12C_CLK (I)(0/3.3V)	61	NC
58	12C_DATA (I/O)(0/3.3V)	59	NC
56	NC	57	GND
54	NC	55	PEWAKE0# (I/O)(0/3.3V)
52	PERST0# (I)(0/3.3V)	53	CLKREQ0# (I/O)(0/3.3V)
50	NC	51	GND
48	NC	49	REFCLKn0
46	NC	47	REFCLKp0
44	NC	45	GND

42	NC	43	PERn0
40	NC	41	PERp0
38	NC	39	GND
36	NC	37	PETn0
34	NC	35	PETp0
32	NC	33	GND
	Module Key		Module Key
	Module Key		Module Key
	Module Key		Module Key
	Module Key		Module Key
22	NC	23	NC
20	NC	21	NC
18	NC	19	NC
16	LED2# (O)(od)	17	NC
14	NC	15	NC
12	NC	13	NC
10	NC	11	NC
8	NC	9	NC
6	LED1# (O)(od)	7	GND
4	3.3V	5	USB_D-
2	3.3V	3	USB_D+
		1	GND

2.4.6 M2B_CN1 : M.2 key B Slot for PCIe Gen3x2 ,SATA3.0 or USB3.2 Gen1 support (Option by BIOS setting)

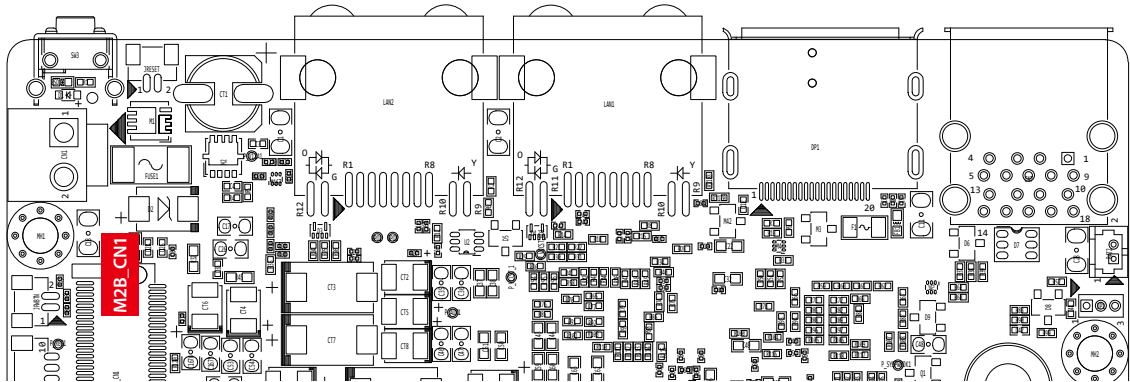

M.2 key B connector is suitable for applications that use wireless connectivity including LTE/5G module, and NVMe SSD (BW : PCIe x2) or SATA SSD that types include 2260/3042/3052. The pin assignments of M2B_CN1 are listed in the following table :

Pin No.	Signal Name	Pin No.	Signal Name
74	3.3V	75	NC
72	3.3V	73	GND
70	3.3V	71	GND
68	NC	69	CONFIG_1
66	SIM DETECT	67	NC
64	NC	65	NC
62	NC	63	NC
60	NC	61	NC
58	NC	59	NC
56	NC	57	GND
54	PEWAKE#	55	REFCLKp
52	CLKREQ#	53	REFCLKn
50	PERST#	51	GND
48	NC	49	PETp0/SATA-A+
46	NC	47	PETn0/SATA-A-
44	NC	45	GND

42	NC	43	PERp0/SATA-B-
40	NC	41	PERn0/SATA-B+
38	DEVSLP	39	GND
36	UIM-PWR	37	PETp1/USB3.1-TX+
34	UIM-DATA	35	PETp1/USB3.1-TX-
32	UIM-CLK	33	GND
30	UIM-RESET	31	PETp1/USB3.1-RX+
28	NC	29	PETp1/USB3.1-RX-
26	NC	27	GND
24	NC	25	NC
22	NC	23	NC
20	NC	21	NC
18	Module Key	19	Module Key
16	Module Key	17	Module Key
14	Module Key	15	Module Key
12	Module Key	13	Module Key
10	LED_1#	11	GND
8	W_DISABLE1	9	USB-
6	FULL_CARD_PWR_OFF/ON	7	USB+
4	3.3V	5	GND
2	3.3V	3	GND
		1	NC

2.4.7 CN2.CN3 : Serial Port

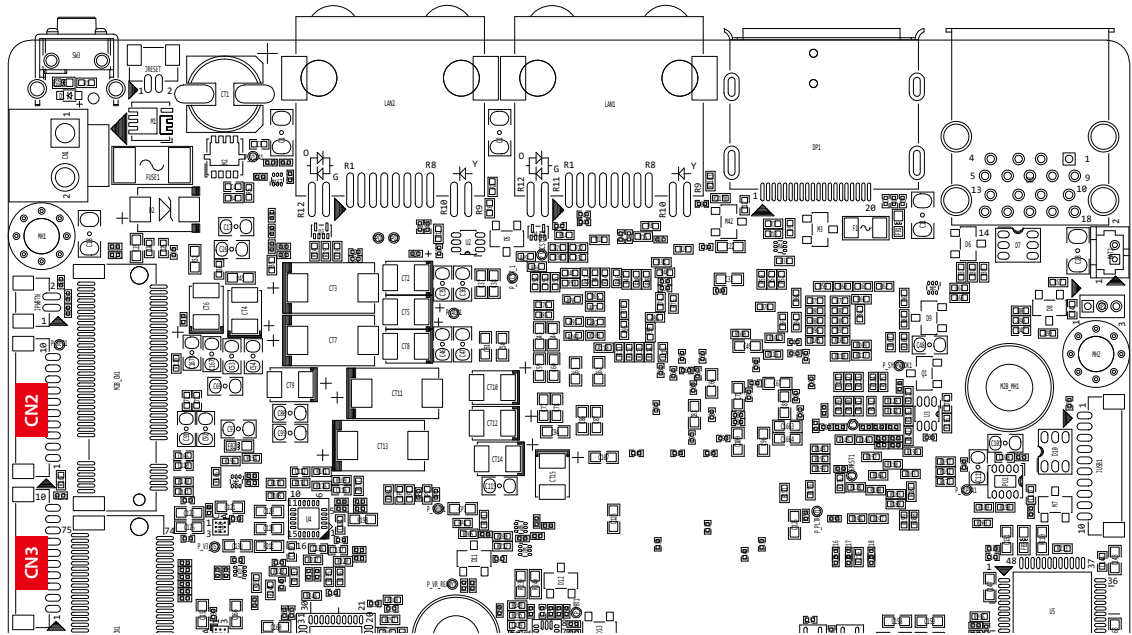

CN3 can be configured for RS-232, RS-422, or RS-485 with auto flow control communication, The default definition is RS-232. CN2 is support RS232 only, if you want to change to RS-422 or RS-485, you can find the setting in BIOS. The pin assignments are listed in the following table:

Serial Port	Pin Number	RS-232	RS-422 (5-wire)	RS-485 (3-wire)
CN2 (RS232 only)	1	DCD	TXD-	DATA-
	2	RXD	TXD+	DATA+
	3	TXD	RXD+	-----
	4	DTR	RXD-	-----
	5	GND	GND	GND
CN3 (Full)	6	DSR	-----	-----
	7	RTS	-----	-----
	8	CTS	-----	-----
	9	RI	-----	-----

2.4.8 CN7 : External USB 3.2 Gen1 Connector

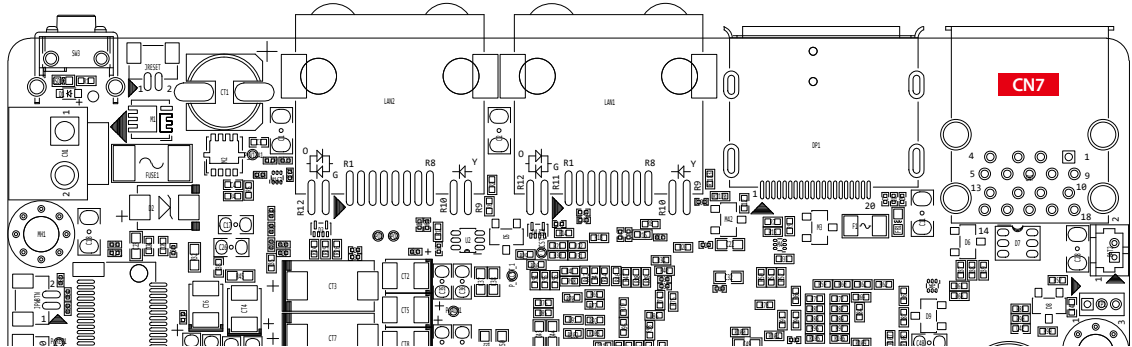

There are 2 USB 3.2 Gen1 connections available supporting up to 5GB per second data rate in the top side of EPBC-1000 series. They are also compliant with the requirements of SuperSpeed (SS), high speed (HS), full speed (FS) and low speed (LS).

2.4.9 CN1 : DC Power input

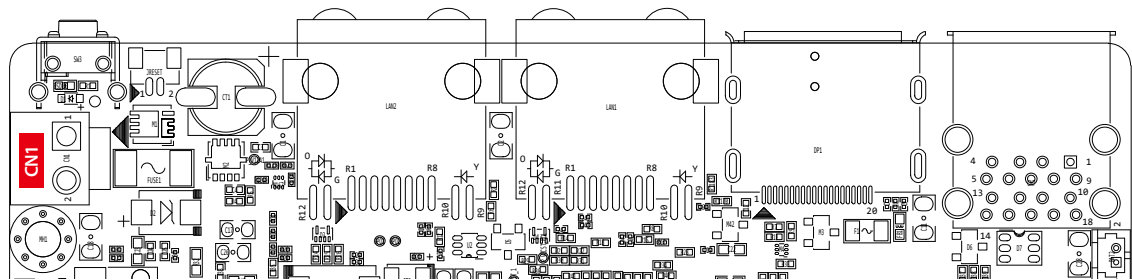

EPBC-1000 supports 12V DC power input by wire-to-board connector in the top side

	Pin No.	Definition	Pin No.	Definition
	1	V-	2	V+

2.4.10 SATA1 : SATA III Connector

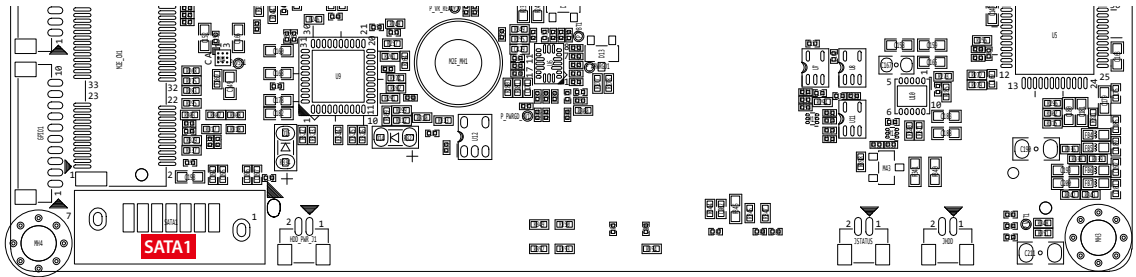

There is a high performance Serial ATA III (SATA III) on the EPBC-1000 series. They support higher storage capacity with less cabling effort and smaller required space. The pin assignments of SATA1 listed in the following table :

	Pin No.	Definition	Pin No.	Definition
	1	GND	2	TXP
	3	TXN	4	GND
	5	RXN	6	RXP
	7	GND		

2.4.11 HDD_PWR_J1 : SATA Power Connector

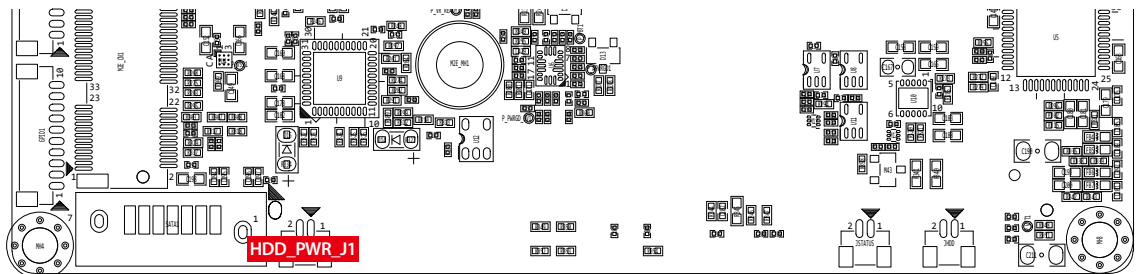

The PBC-1000 series is also equipped with one SATA power connector. It supports 5V (Up to 1.2A) a to the SSD only. The pin assignments of HDD_PWR_J1 is listed in the following table

	Pin No.	Definition	Pin No.	Definition
	1	+5V	2	GND

2.4.12 JReset, JStatus, JHDD : 1.0mm 2p extend header

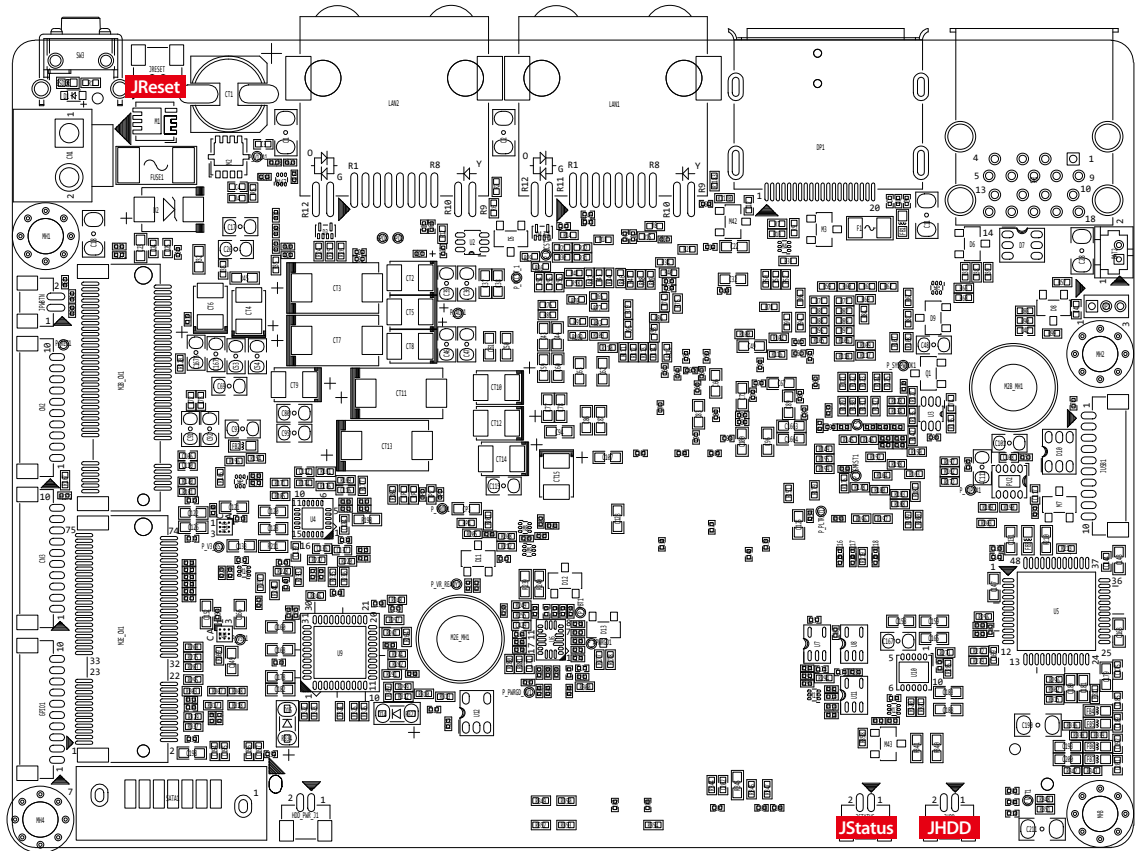

These pin header can be used as a backup for following functions, hard drive LED indicator, reset button, power LED indicator, The pin assignments are listed in the following table :

	Pin No.	Pin No.	Definition
	JRESET		1
		2	GND
JSTATUS		1	PWR_LED_P
		2	PWR_LED_N
JHDD		1	HDD_LED_P
		2	HDD_LED_N

2.4.13 J80p1 : I2C/SMB header

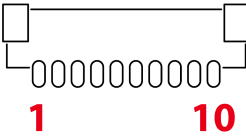
	Pin No.	Definition
	1	+3.3V
	2	NC
	3	NC
	4	SMBUS_DAT
	5	SMBUS_CLK
	6	I2C_DAT
	7	I2C_CLK
	8	NC
	9	NC
	10	GND

2.4.14 JDIO1 : 8bit GPIO Header (only support 3.3V)

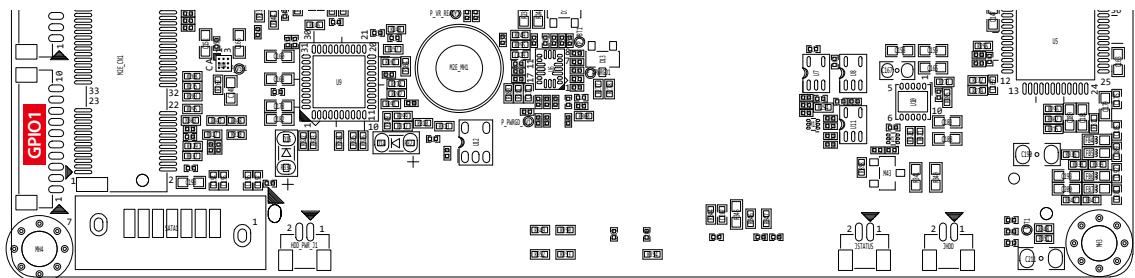

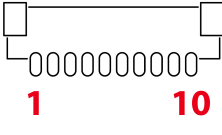
	Pin No.	Definition
	1	SIO_GPIO1
	2	SIO_GPIO2
	3	SIO_GPIO3
	4	SIO_GPIO4
	5	SIO_GPIO5
	6	SIO_GPIO6
	7	SIO_GPIO7
	8	SIO_GPIO8
	9	+3.3V
	10	GND

2.5 Main Board Jumper Settings

2.5.1 Top View of PBC-1000 Main Board With Jumper Location

The figure below is the top view of the EPBC-1000 main board. It shows the location of the jumpers.

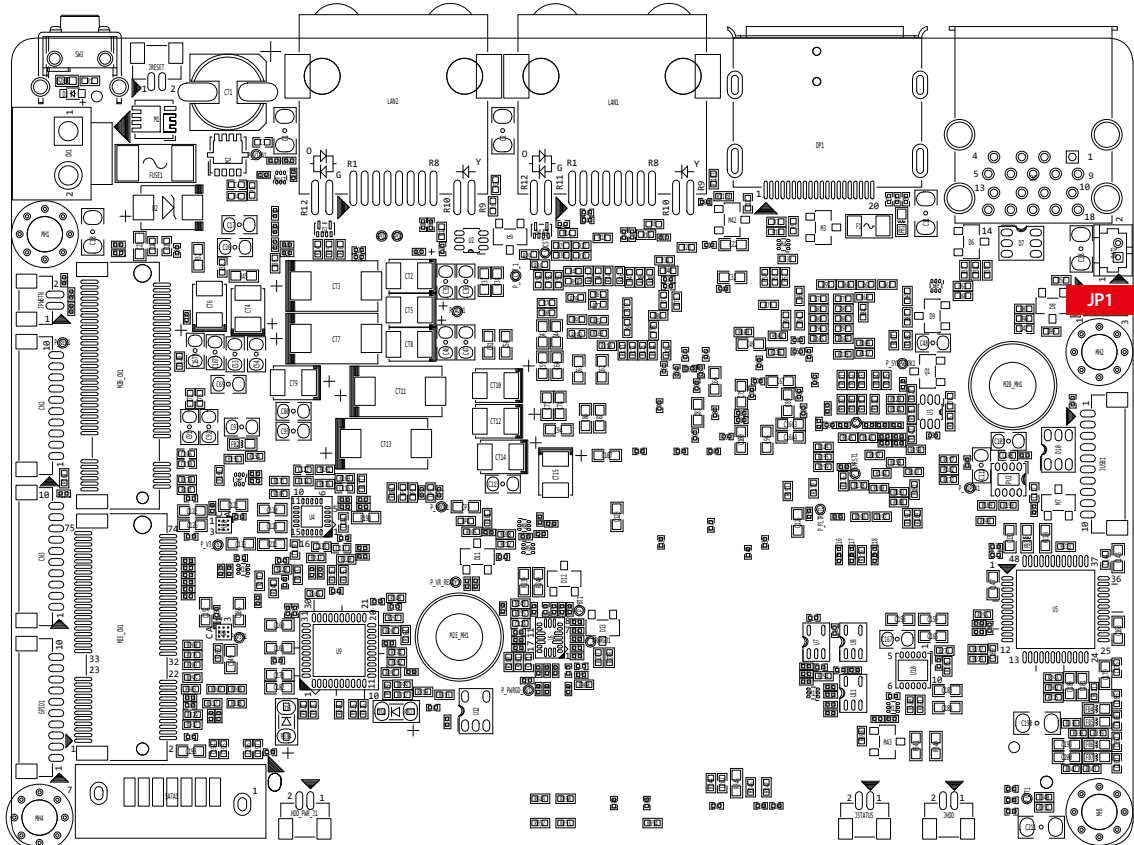

You may configure your card to match the needs of your application by setting jumpers. A jumper is a metal bridge used to close an electric circuit. It consists of two metal pins and a small metal clip (often protected by a plastic cover) that slides over the pins to connect them. To "close" a jumper, you connect the pins with the clip. To "open" a jumper, you remove the clip. Sometimes a jumper will have three pins, labeled 1, 2, and 3. In this case you would connect either pins 1 and 2, or 2 and 3.

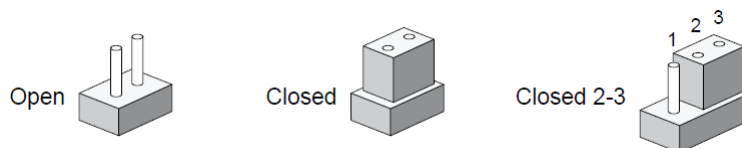

2.3.2 JP1 : Clear CMOS

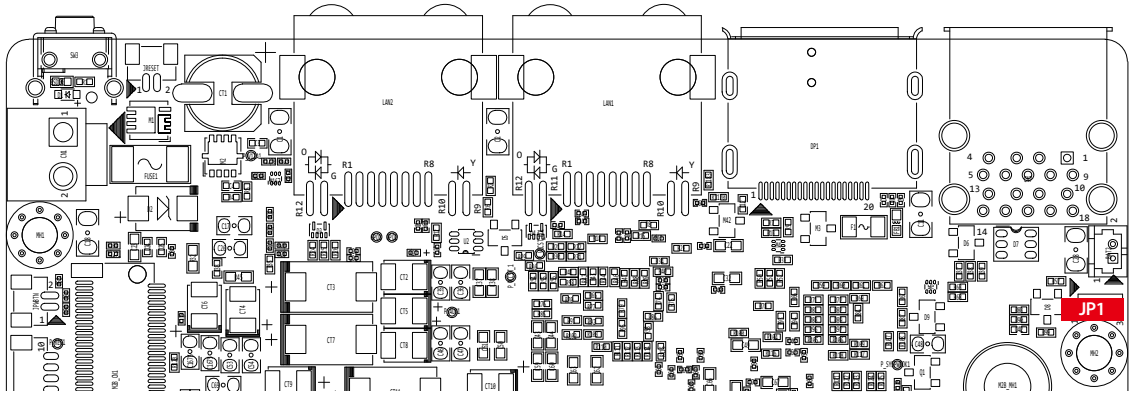

		Pin No.	Definition
1  3		1-2	Normal (default)
		2-3	Clear CMOS

3

SETUP

3.1 How to Open Your PBC-1000

Step 1 Remove the Screw indicated and separate Cover from the enclosure.

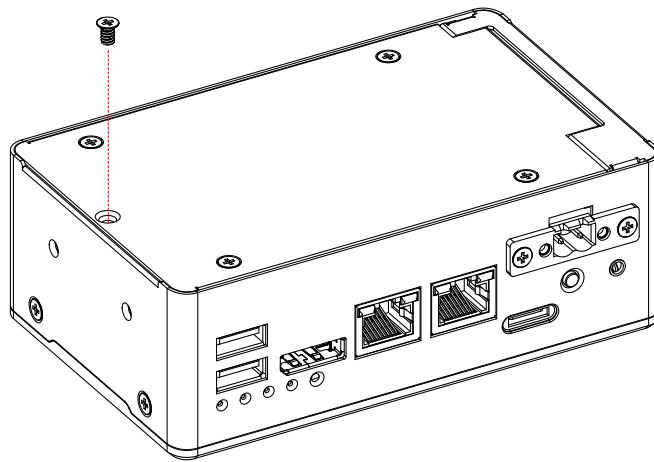

Step 1 Remove the bottom cover.

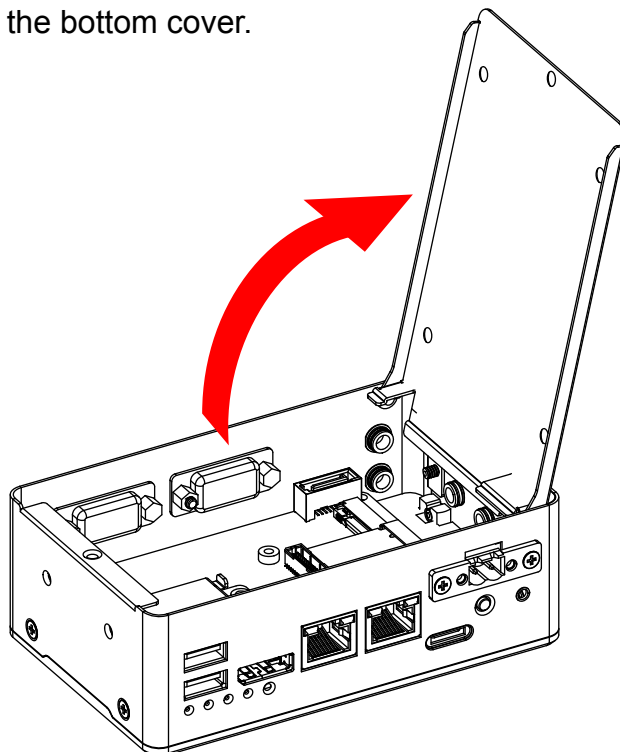

3.2 Installing DDR4 SO-DIMM Modules

Step 1 Remove four #6-32 Screws, two M3 Screws indicated and separate Cover from the enclosure.

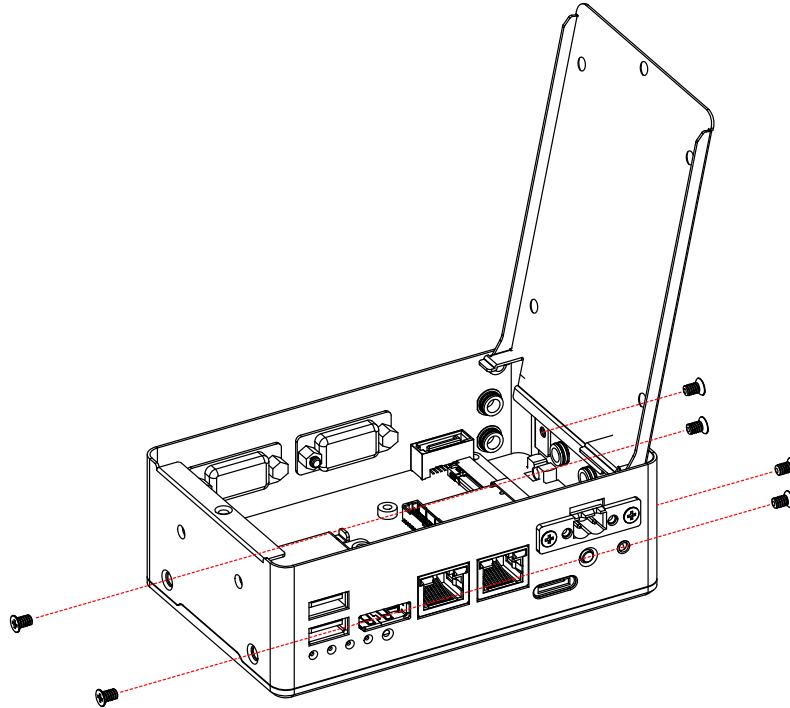

Step 2 Remove the screws indicated and separate the heat-sink from the PCB.

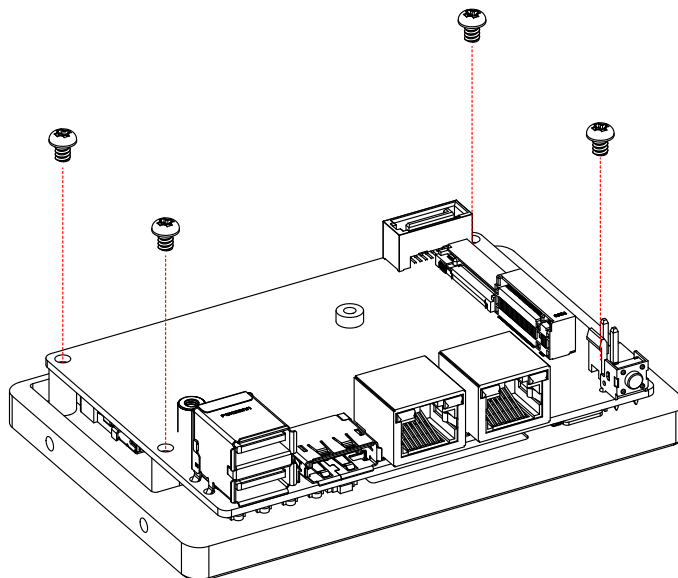

Step 3 Install DDR4 RAM module into SO-DIMM socket.

Step 4 Finished.

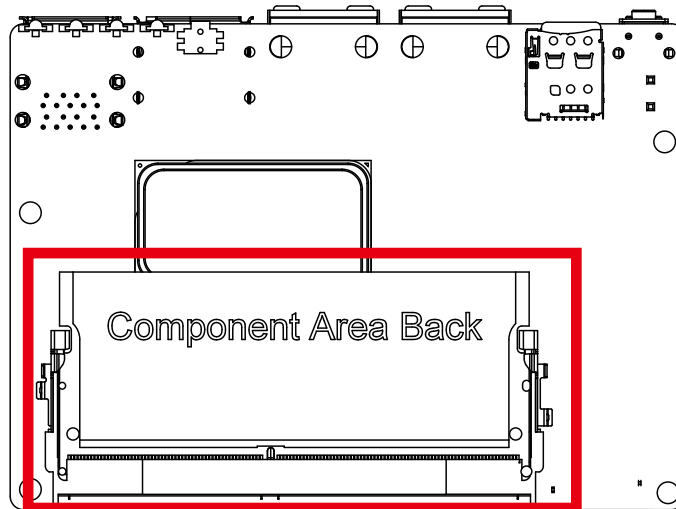

3.3 Installing SIM Card

Step 1 Install SIM card into the SIM card slot.

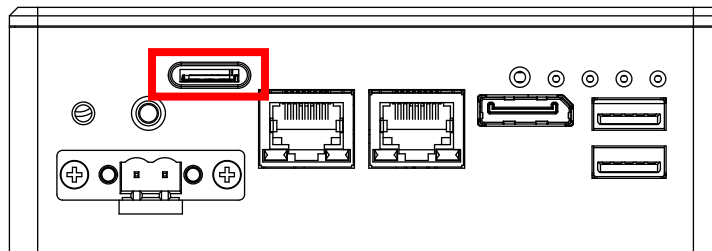

3.4 Installing SSD/HDD

Step 1 Remove the bottom cover.

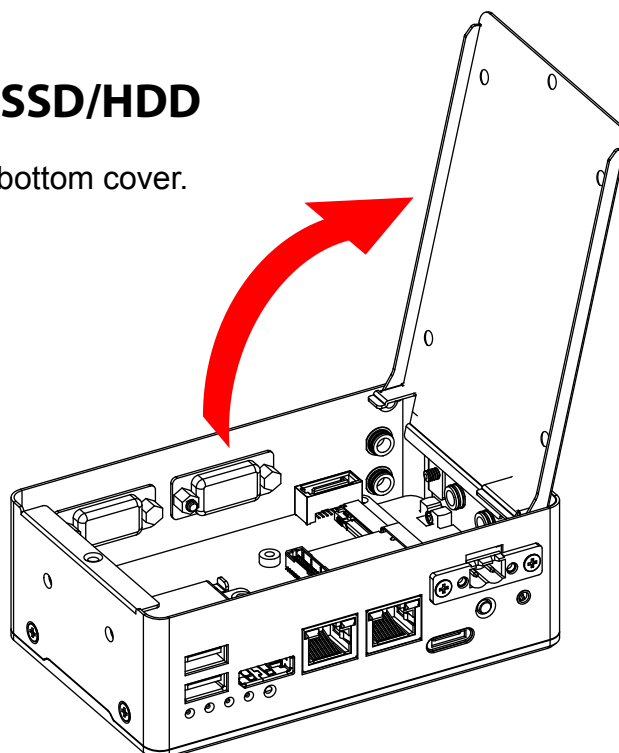

Step 2 Fasten four Screws indicated.

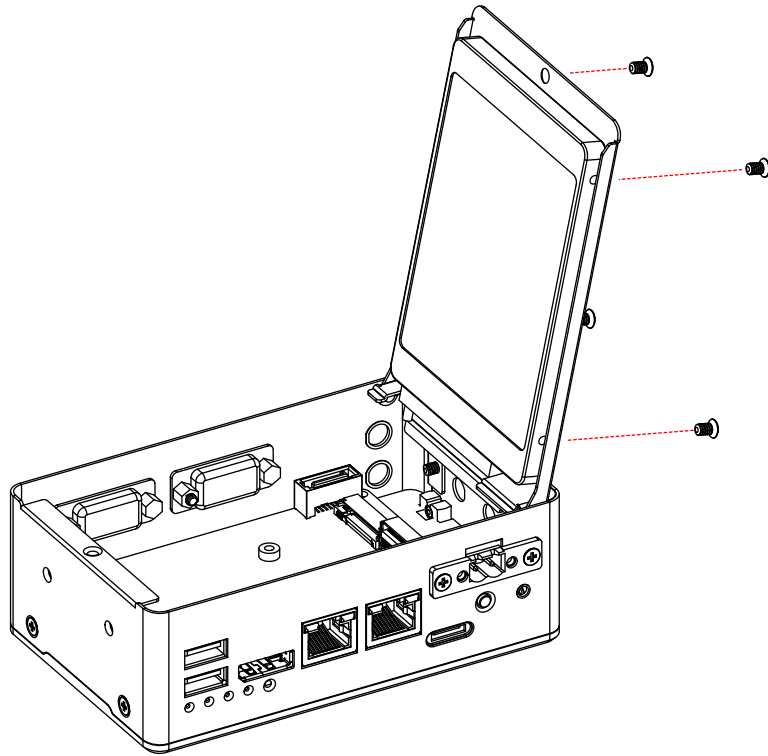

3.5 Installing M.2

3.5.1 Key E 2230

Step 1 Install M.2 into the M.2 slot and fasten M3 screw indicated.

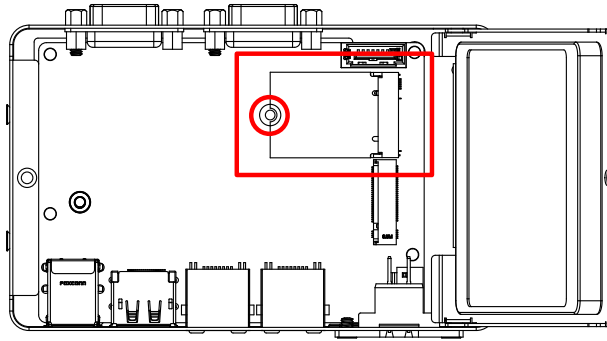

3.5.2 Key B 2280

Step 1 Install M.2 into the M.2 slot and fasten M3 screw indicated.

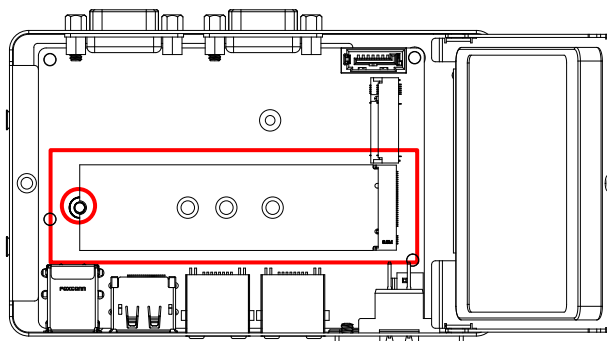

3.5.3 Key B 3042

Step 1 Install M.2 with M.2 Tray into the M.2 slot and fasten M3 screw indicated.

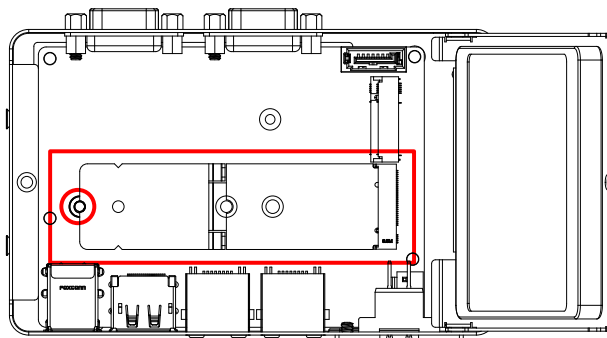

3.5.4 Key B 3052

Step 1 Install M.2 with M.2 Tray into the M.2 slot and fasten M3 screw indicated.

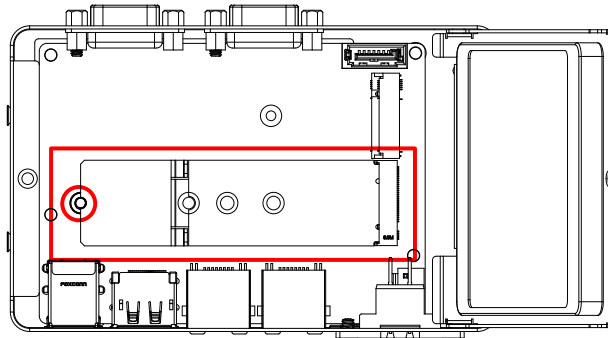

3.6 Installing Antenna cable

Step 1 Check antenna cable and washers.



Step 2 Install antenna cable and then fasten washer and nut.

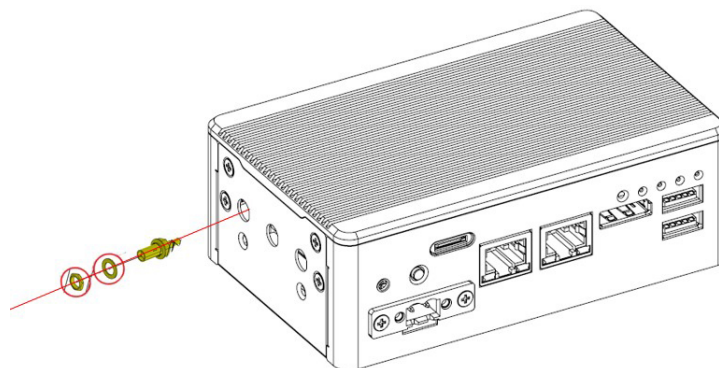

3.7 Mounting Your PBC-1000

3.7.1 Install wall mount to PBC-1000, Install four F head M3x4L screws

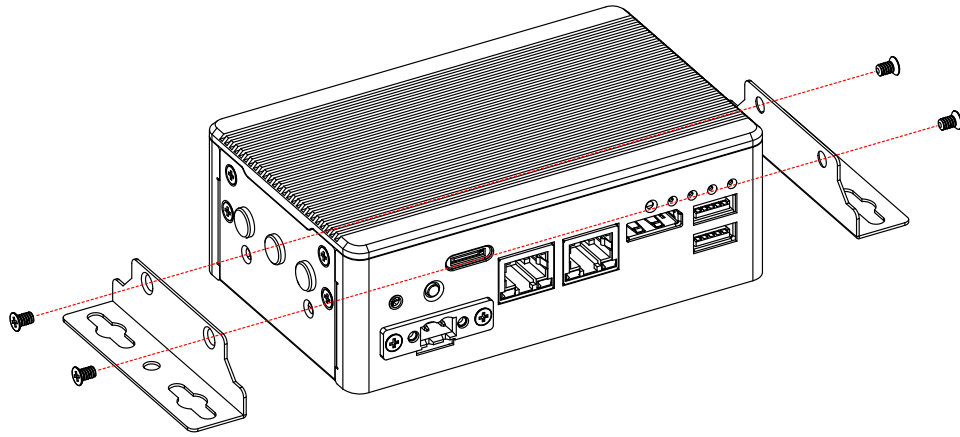

3.7.2 Install DIN Rail Kit to PBC-1000 Wall mount, Install four M3x4L screws

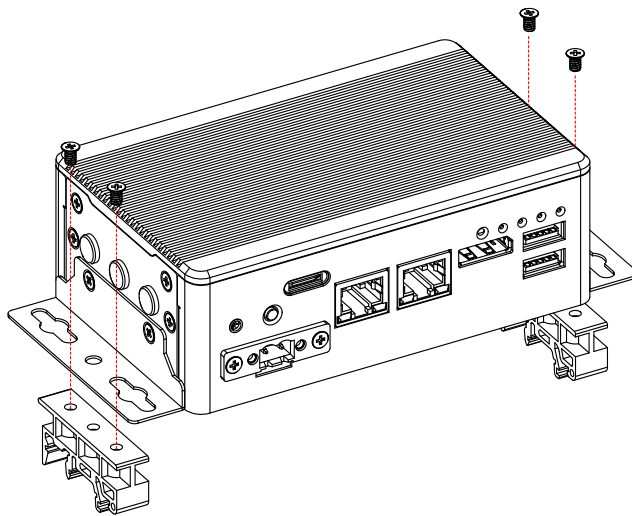

4

BIOS SETUP

4.1 BIOS Setup

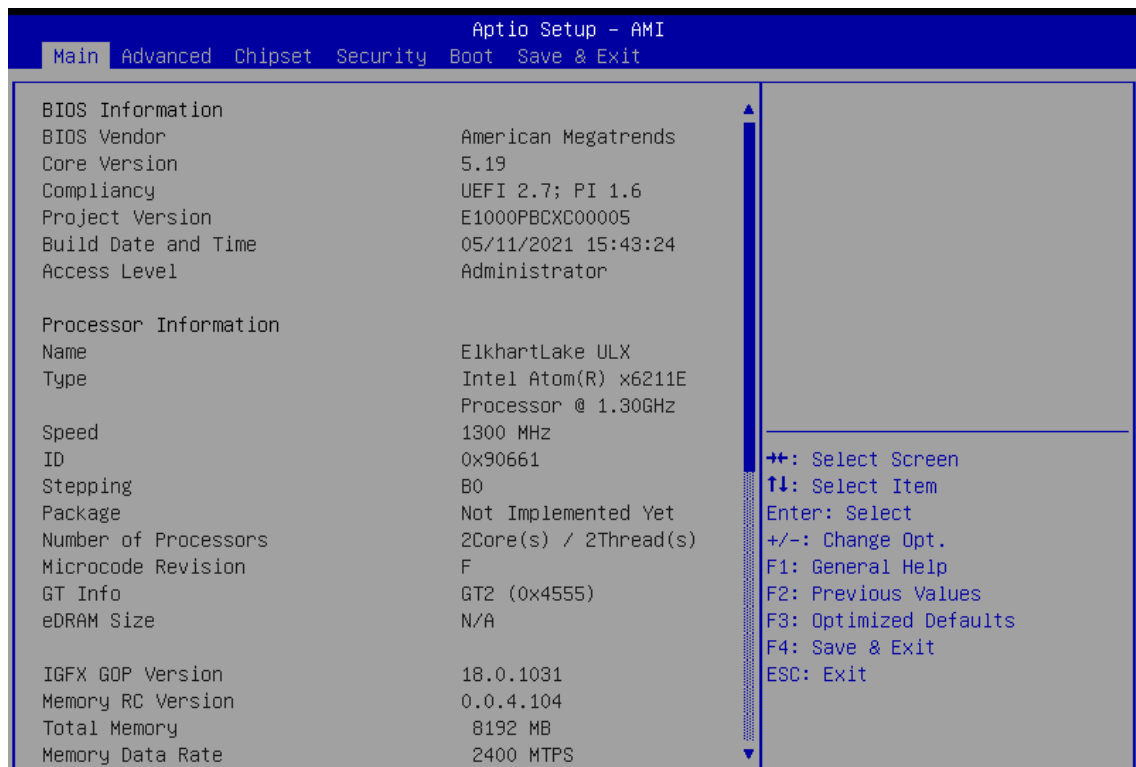

Figure 4-1 : Entering Setup Screen

BIOS provides an interface for users to check and change system configuration. The BIOS setup program is accessed by pressing the key when POST display output is shown.

4.2 Main Menu

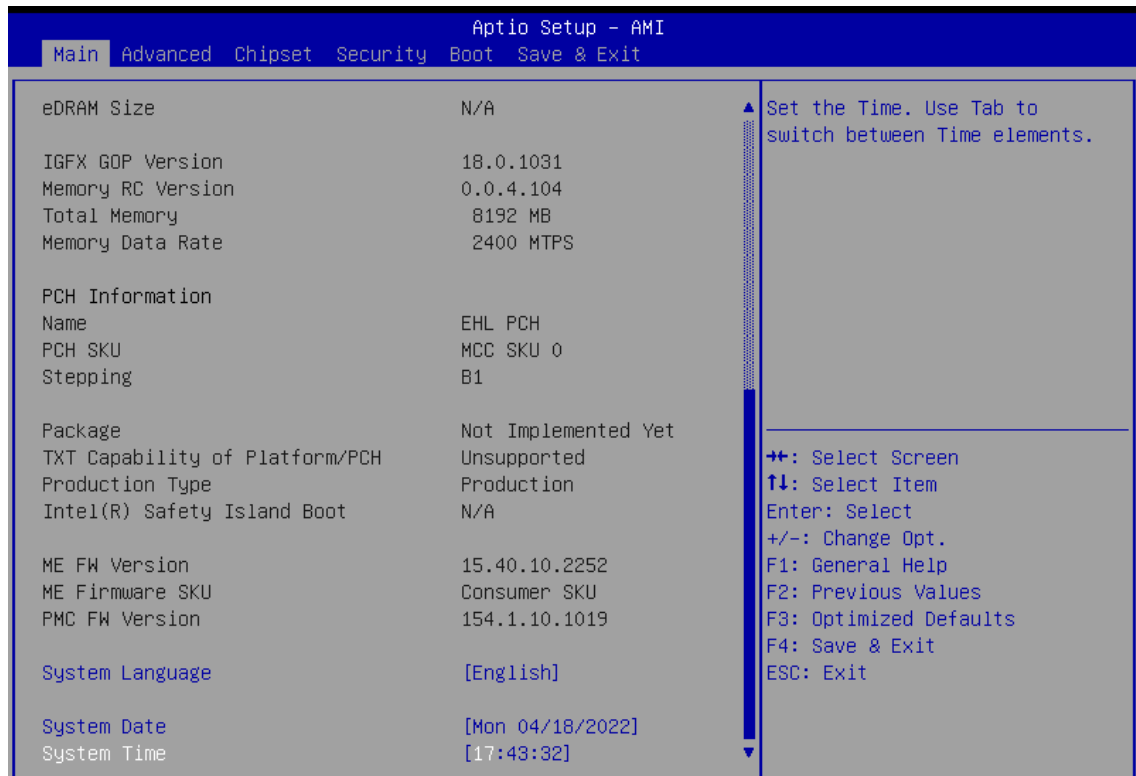

Figure 4-2 : BIOS Main Menu

The main menu displays BIOS version and system information. There are two options on the main menu, system date and system time.

System Date

Set the date. Use Tab to switch between date elements.

System Time

Set the time. Use Tab to switch between time elements.

4.3 Advanced Functions

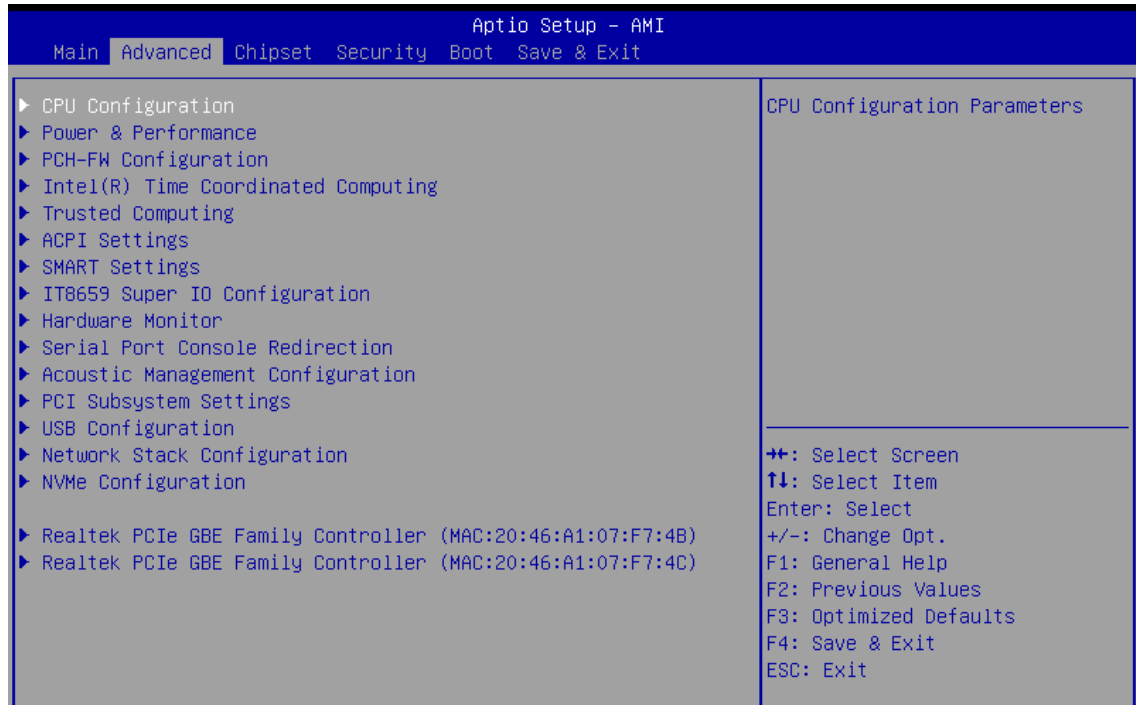

Figure 4-3 : BIOS Advanced menu

Select advanced tab to enter advanced BIOS setup options such as CPU configuration, USB configuration, and Network Stack configuration.

4.3.1 CPU Configuration

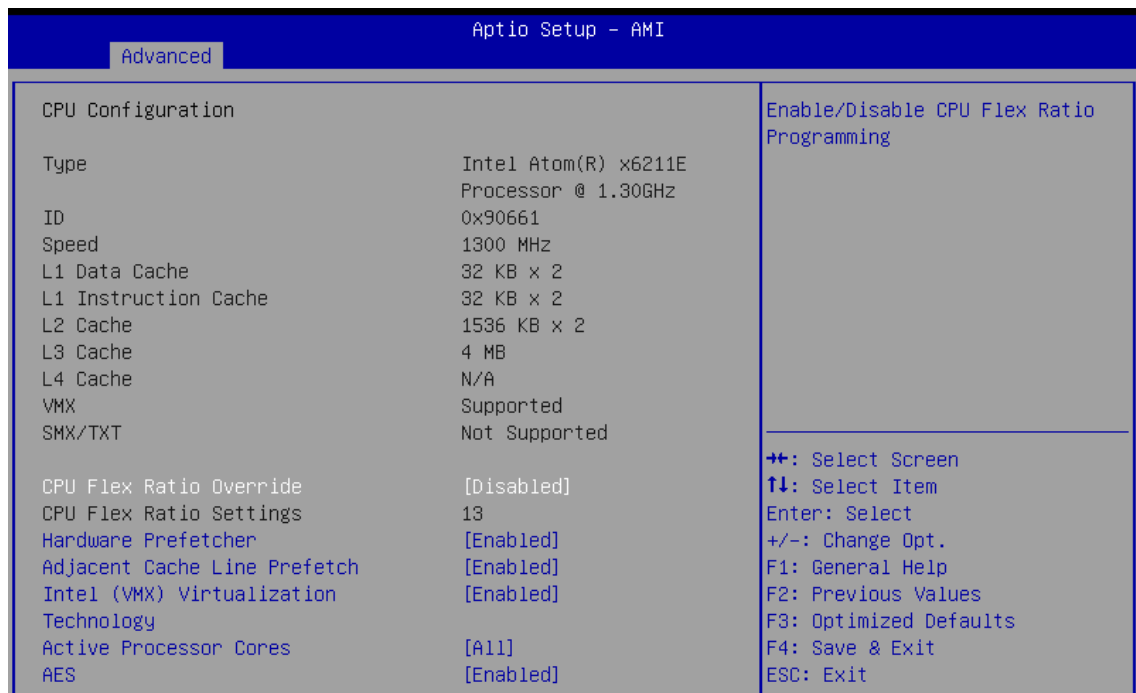

Figure 4-3-1 : CPU Configuration

CPU Flex Ratio Override

Enable/Disable CPU Flex Ratio Programming.

Hardware Prefetcher

To turn on/off the MLC streamer prefetcher.

Adjacent Cache Line Prefetch

To turn on/off prefetching of adjacent cache lines.

Intel (VMX) Virtualization Technology

When enabled, a VMM can utilize the additional hardware capabilities provided by Vanderpool Technology.

Active Processor Cores

Number of cores to enable in each processor package.

AES

Enable/Disable AES (Advanced Encryption Standard).

4.3.2 Power & Performance



Figure 4-3-2 : Power & Performance

4.3.2.1 CPU - Power Management Control

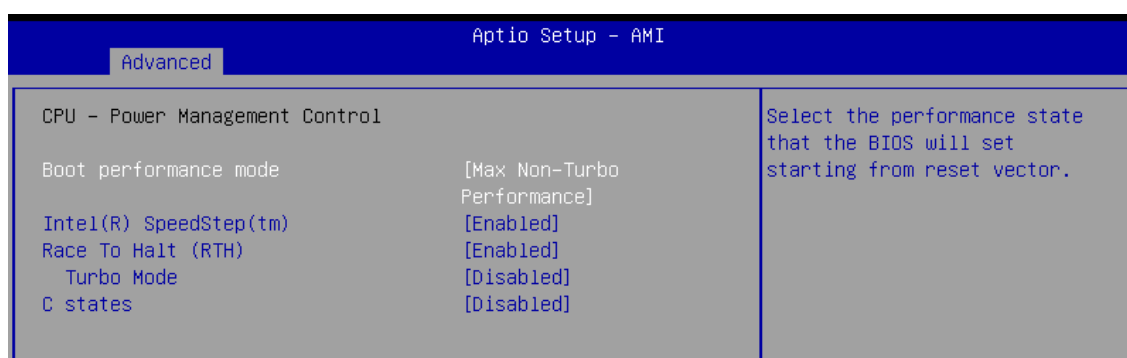

Figure 4-3-2-1 : CPU - Power Management Control

Boot performance mode

Select the performance state that the BIOS will set starting from reset vector.

Intel(R) SpeedStep(tm)

Allows more than two frequency ranges to be supported.

Race To Halt (RTH)

Enable/Disable Race To Halt feature. RTH will dynamically increase CPU frequency in order to enter pkg C-State faster to reduce overall power. (RTH is controlled through MSR 1FC bit 20).

Turbo Mode

Enable/Disable processor Turbo Mode (requires EMTTM enabled too). AUTO means enabled.

C states

Enable/Disable CPU Power Management. Allows CPU to go to C states when it's not 100% utilized.

4.3.2.2 GT - Power Management Control

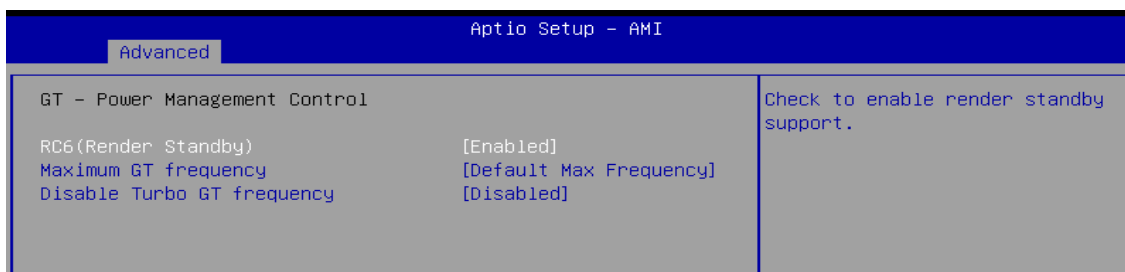

Figure 4-3-2-2 : GT - Power Management Control

RC6(Render Standby)

Check to enable render standby support.

Maximum GT frequency

Maximum GT frequency limited by the user. Choose between 200MHz (RPN) and 750MHz (RP0). Value beyond the range will be clipped to min/max supported by SKU.

Disable Turbo GT frequency

Enabled: Disables Turbo GT frequency. Disabled: GT frequency is not limited.

4.3.3 PCH-FW Configuration

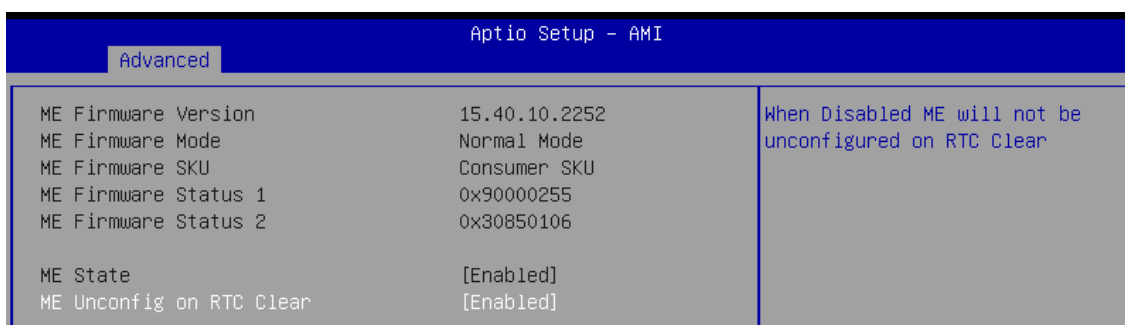

Figure 4-3-3 : PCH-FW Configuration

ME State

CWhen Disabled ME will be put into ME Temporarily Disabled Mode.

ME Unconfig on RTC Clear

When Disabled ME will not be unconfigured on RTC Clear.

4.3.4 Intel(R) Time Coordinated Computing

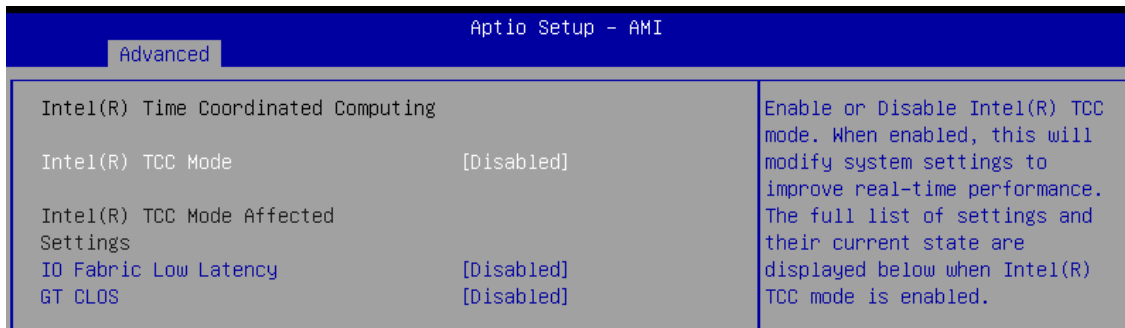

Advanced		Aptio Setup - AMI
Intel(R) Time Coordinated Computing		Enable or Disable Intel(R) TCC mode. When enabled, this will modify system settings to improve real-time performance. The full list of settings and their current state are displayed below when Intel(R) TCC mode is enabled.
Intel(R) TCC Mode	[Disabled]	
Intel(R) TCC Mode Affected Settings		
IO Fabric Low Latency	[Disabled]	
GT CLOS	[Disabled]	

Figure 4-3-4 : Intel(R) Time Coordinated Computing

Intel(R) TCC Mode

Enable or Disable Intel(R) TCC mode. When enabled, this will modify system settings to improve real-time performance. The full list of settings and their current state are displayed below when Intel(R) TCC mode is enabled.

IO Fabric Low Latency

Enable or Disable IO Fabric Low Latency. This will turn off some power management in the PCH IO fabrics. This option provides the most aggressive IO Fabric performance setting. S3 state is NOT supported.

GT CLOS

Enable or Disable Graphics Technology(GT) Class of Service. Enable will reduce Gfx LLC allocation to minimize impact of Gfx workload on LLC.

4.3.5 Trusted Computing

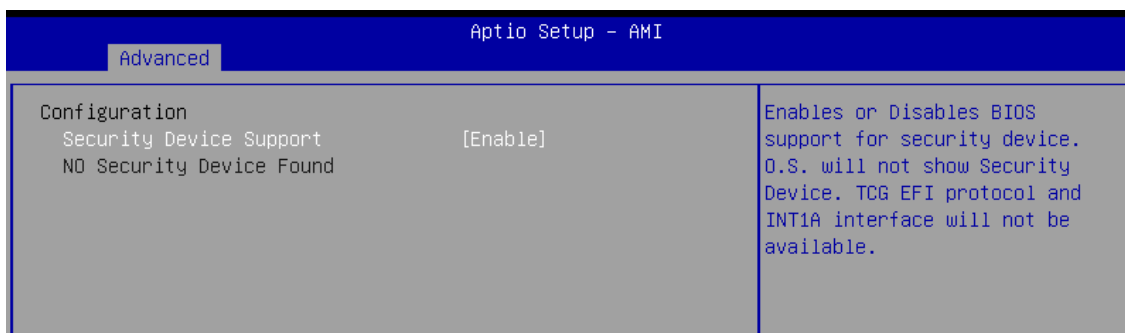

Advanced		Aptio Setup - AMI
Configuration		Enables or Disables BIOS support for security device. O.S. will not show Security Device. TCG EFI protocol and INT1A interface will not be available.
Security Device Support	[Enable]	
NO Security Device Found		

Figure 4-3-5 : Trusted Computing

Control the TPM device status and display related information if TPM chip is present.

4.3.6 ACPI Settings

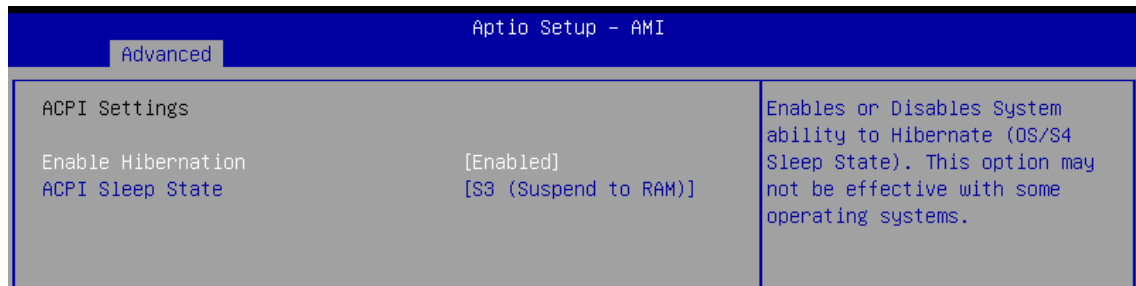

Figure 4-3-6 : ACPI Settings

Enable Hibernation

Enables or Disables System ability to Hibernate (OS/S4 Sleep State). This option may not be effective with some operating systems.

ACPI Sleep State

Select the highest ACPI sleep state the system will enter when the SUSPEND button is pressed.

4.3.7 SMART Settings

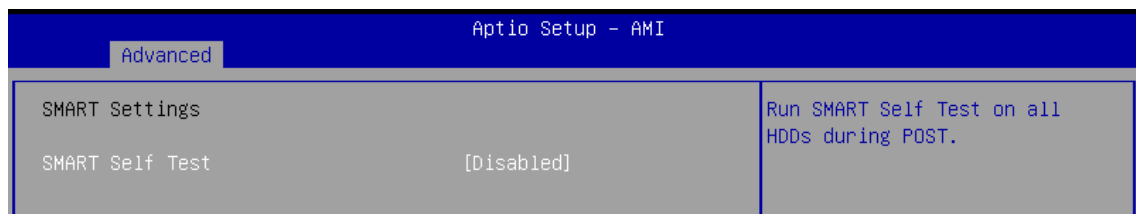

Figure 4-3-7 : SMART Settings

SMART Self Test

Run SMART Self Test on all HDDs during POST.

4.3.8 IT8786 Super IO Configuration

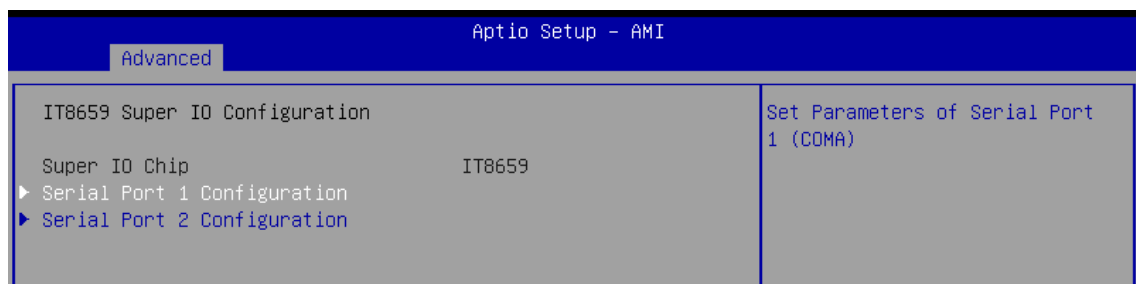

Figure 4-3-8 : IT8786 Super IO Configuration

Serial Port 1 Configuration

Set Parameters of Serial Port 1 (COMA).

Serial Port 2 Configuration

Set Parameters of Serial Port 2 (COMB).

4.3.9 Hardware Monitor

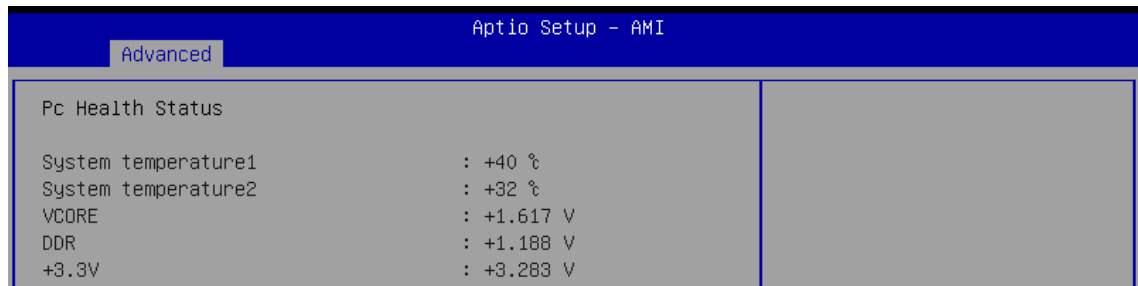

Figure 4-3-9 : Hardware Monitor

The IT8786 SIO features an enhanced hardware monitor providing thermal, fan speed, and system voltages' status monitoring.

4.3.10 Serial Port Console Redirection

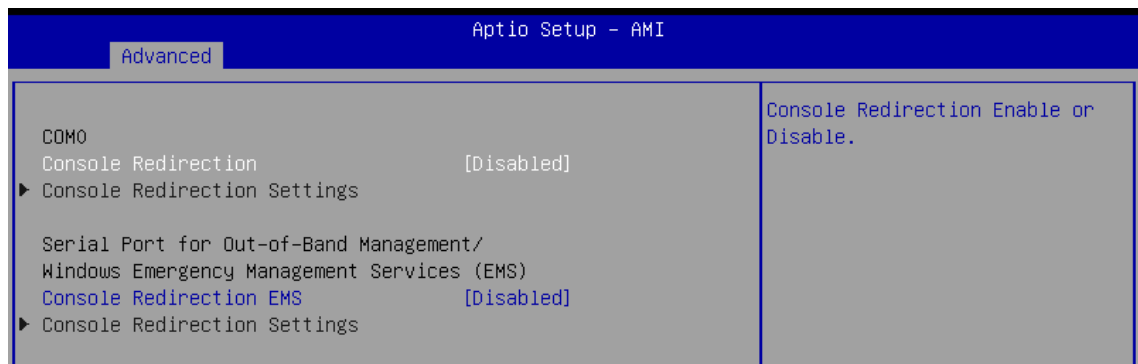

Figure 4-3-10 : Serial Port Console Redirection

Console Redirection

Console Redirection Enable or Disable.

Console Redirection Settings

The settings specify how the host computer and the remote computer (which the user is using) will exchange data. Both computers should have the same or compatible settings.

Console Redirection EMS

Console Redirection Enable or Disable.

Console Redirection Settings

The settings specify how the host computer and the remote computer (which the user is using) will exchange data. Both computers should have the same or compatible settings.

4.3.11 Acoustic Management Configuration

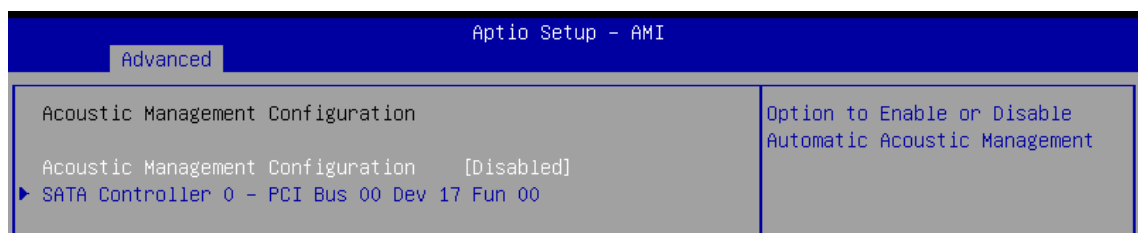

Figure 4-3-11 : Acoustic Management Configuration

Acoustic Management Configuration

Option to Enable or Disable Automatic Acoustic Management.

4.3.12 PCI Subsystem Settings



Figure 4-3-12 : PCI Subsystem Settings

BME DMA Mitigation

Re-enable Bus Master Attribute disabled during Pci enumeration for PCI Bridges after SMM Locked.

4.3.13 USB Configuration

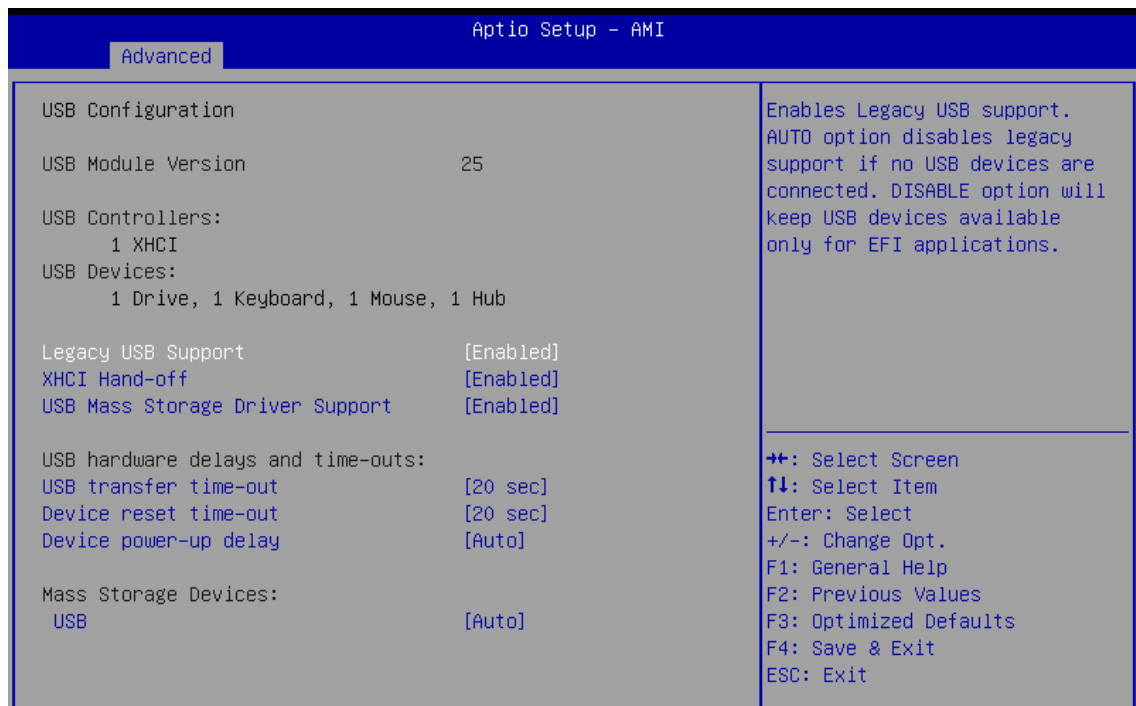

Figure 4-3-13 : USB Configuration

Legacy USB Support

Enables Legacy USB support. AUTO option disables legacy support if no USB devices are connected. DISABLE option will keep USB devices available only for EFI applications.

XHCI Hand-off

This is a workaround for OSeS without XHCI hand-off support. The XHCI ownership change should be claimed by XHCI driver.

USB Mass Storage Driver Support

Enable/Disable USB Mass Storage Driver Support.

USB transfer time-out

The time-out value for Control, Bulk, and Interrupt transfers.

Device reset time-out

USB mass storage device Start Unit command time-out.

Device power-up delay

Maximum time the device will take before it properly reports itself to the Host Controller. 'Auto' uses default value: for a Root port it is 100 ms, for a Hub port the delay is taken from Hub descriptor.

4.3.14 Network Stack Configuration

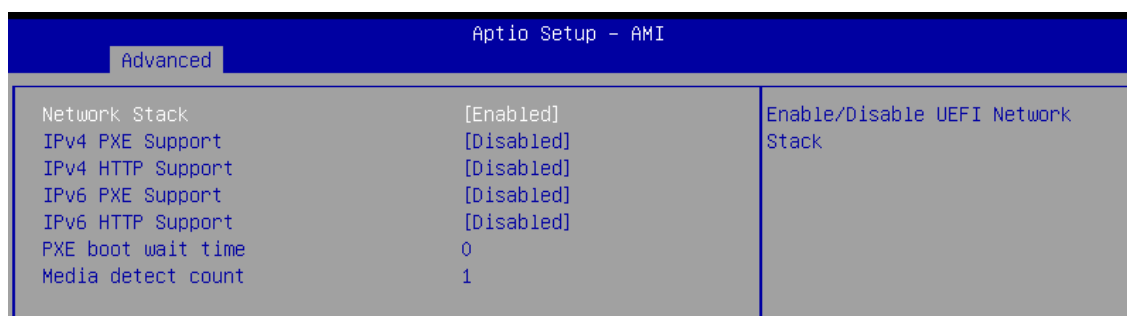

Aptio Setup - AMI		
Advanced		
Network Stack	[Enabled]	Enable/Disable UEFI Network Stack
IPv4 PXE Support	[Disabled]	
IPv4 HTTP Support	[Disabled]	
IPv6 PXE Support	[Disabled]	
IPv6 HTTP Support	[Disabled]	
PXE boot wait time	0	
Media detect count	1	

Figure 4-3-14 : Network Stack Configuration

Network Stack

Enable/Disable UEFI Network Stack.

IPv4 PXE Support

Enable/Disable IPv4 PXE boot support. If disabled, IPv4 PXE boot support will not be available.

IPv4 HTTP Support

Enable/Disable IPv4 HTTP boot support. If disabled, IPv4 HTTP boot support will not be available.

IPv6 PXE Support

Enable/Disable IPv6 PXE boot support. If disabled, IPv6 PXE boot support will not be available.

IPv6 HTTP Support

Enable/Disable IPv6 HTTP boot support. If disabled, IPv6 HTTP boot support will not be available.

PXE boot wait time

Wait time in seconds to press ESC key to abort the PXE boot. Use either +/- or numeric keys to set the value.

Media detect count

Number of times the presence of media will be checked. Use either +/- or numeric keys to set the value.

4.3.15 NVMe Configuration



Figure 4-3-15 : NVMe Configuration

Display NVMe Controller and Drive information.

4.4 Chipset Functions

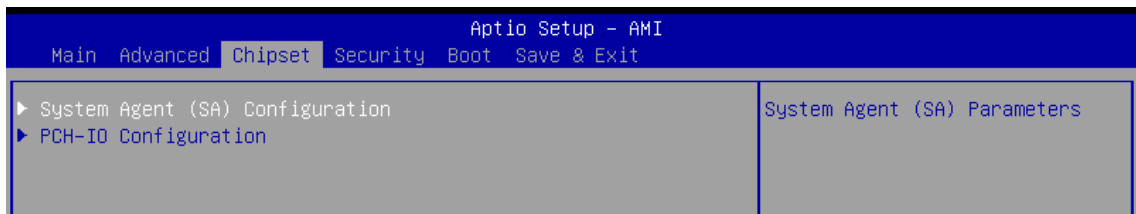

Figure 4-4 : BIOS Chipset Menu

Select chipset tab to enter chipset BIOS setup options such as SA configuration and PCH-IO configuration.

4.4.1 System Agent (SA) Configuration

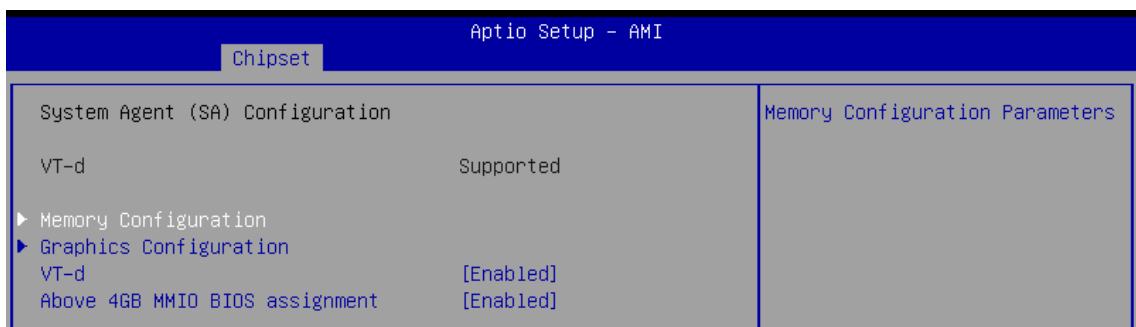

Figure 4-4-1 : System Agent (SA) Configuration

VT-d

VT-d capability.

Above 4GB MMIO BIOS assignment

Enable/Disable above 4GB MemoryMappedIO BIOS assignment. This is enabled automatically when Aperture Size is set to 2048MB.

4.4.1.1 Memory Configuration

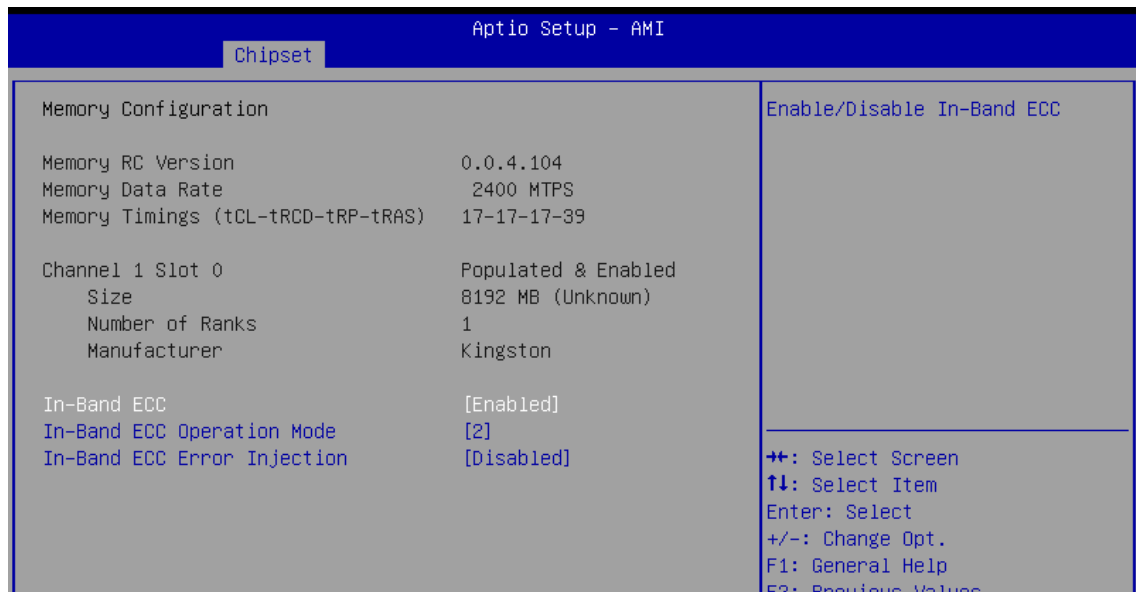

Figure 4-4-1-1 : Memory Configuration

In-Band ECC

Enable/Disable In-Band ECC.

In-Band ECC Operation Mode

0: Functional Mode protects requests based on the address range, 1: Makes all requests non protected and ignore range checks, 2: Makes all requests protected and ignore range checks.

In-Band ECC Error Injection

By enabling this Error Injection Enabling feature, the user acknowledges the security risks. Enabling Error Injection allows attackers who have access to the Host Operating System to inject IB ECC errors that can cause unintended memory corruption and enable the leak of security data in the BIOS stolen memory regions.

4.4.1.2 Graphics Configuration

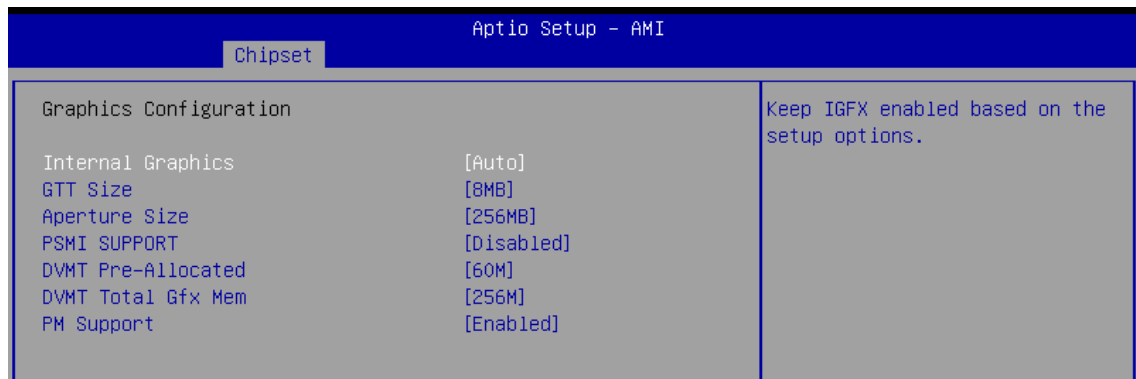

Figure 4-4-1-2 : Graphics Configuration

Internal Graphics

Keep IGFX enabled based on the setup options.

GTT Size

Select the GTT Size.

Aperture Size

Select the Aperture Size. Note : Above 4GB MMIO BIOS assignment is automatically enabled when selecting 2048MB aperture. To use this feature, please disable CSM Support.

PSMI SUPPORT

PSMI Enable/Disable.

DVMT Pre-Allocated

Select DVMT 5.0 Pre-Allocated (Fixed) Graphics Memory size used by the Internal Graphics Device.

DVMT Total Gfx Mem

Select DVMT5.0 Total Graphic Memory size used by the Internal Graphics Device.

PM Support

Enable/Disable PM Support.

4.4.2 PCH-IO Configuration

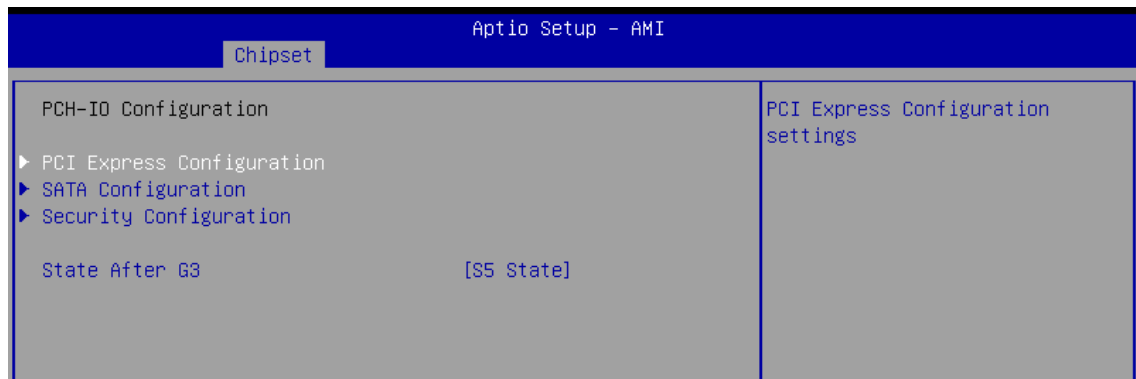

Figure 4-4-2 : PCH-IO Configuration

State After G3

Specify what state to go to when power is re-applied after a power failure (G3 state).

4.4.2.1 PCI Express Configuration

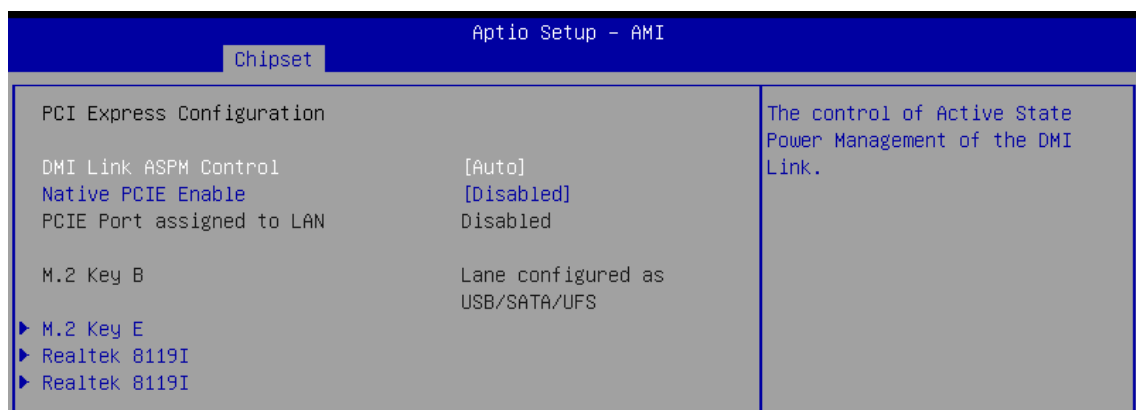

Figure 4-4-2-1 : PCI Express Configuration

DMI Link ASPM Control

The control of Active State Power Management of the DMI Link.

Native PCIE Enable

Bit - PCIe Native * control

0 - ~ Hot Plug

1 - SHPC Native Hot Plug control

2 - ~ Power Management Events

3 - PCIe Advanced Error Reporting control

4 - PCIe Capability Structure control

5 - Latency Tolerance Reporting control

PCI Express device settings

BIOS options for PCI Express device setting.

4.4.2.2 SATA Configuration

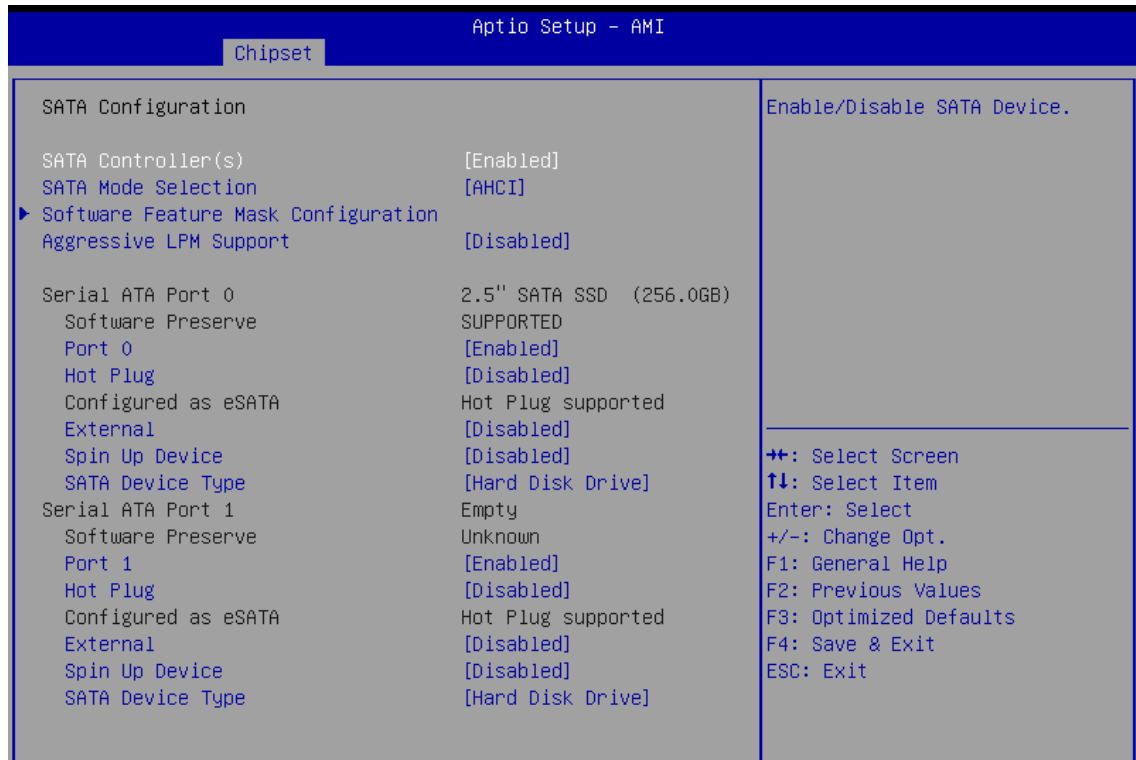

Figure 4-4-2-2 : SATA Configuration

SATA Controller(s)

Enable/Disable SATA Device.

SATA Mode Selection

Determines how SATA controller(s) operate.

Software Feature Mask Configuration

RST Legacy OROM/RST UEFI driver will refer to the SWFM configuration to enable/disable the storage features.

Aggressive LPM Support

Enable PCH to aggressively enter link power state.

Port n

Enable or Disable SATA Port.

Hot Plug

Designates this port as Hot Pluggable.

External

Marks this port as external.

Spin Up Device

If enabled for any of ports Staggered Spin Up will be performed and only the drives which have this option enabled will spin up at boot. Otherwise all drives spin up at boot.

SATA Device Type

Identify the SATA port is connected to Solid State Drive or Hard Disk Drive.

4.4.2.3 Security Configuration

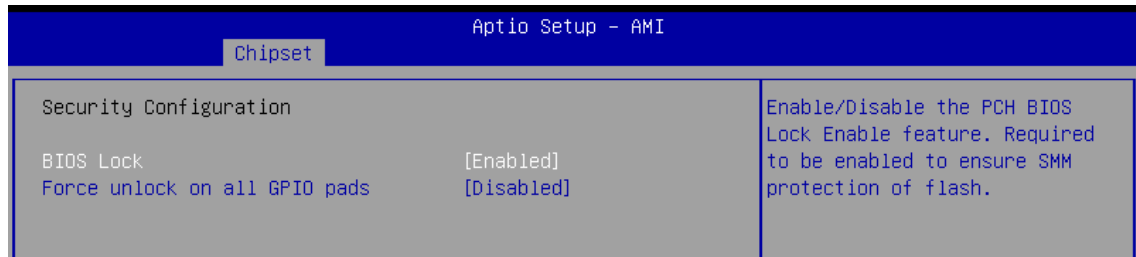

Figure 4-4-2-3 : Security Configuration

BIOS Lock

Enable/Disable the PCH BIOS Lock Enable feature. Required to be enabled to ensure SMM protection of flash.

Force unlock on all GPIO pads

If Enabled BIOS will force all GPIO pads to be in unlocked state.

4.5 Security Function

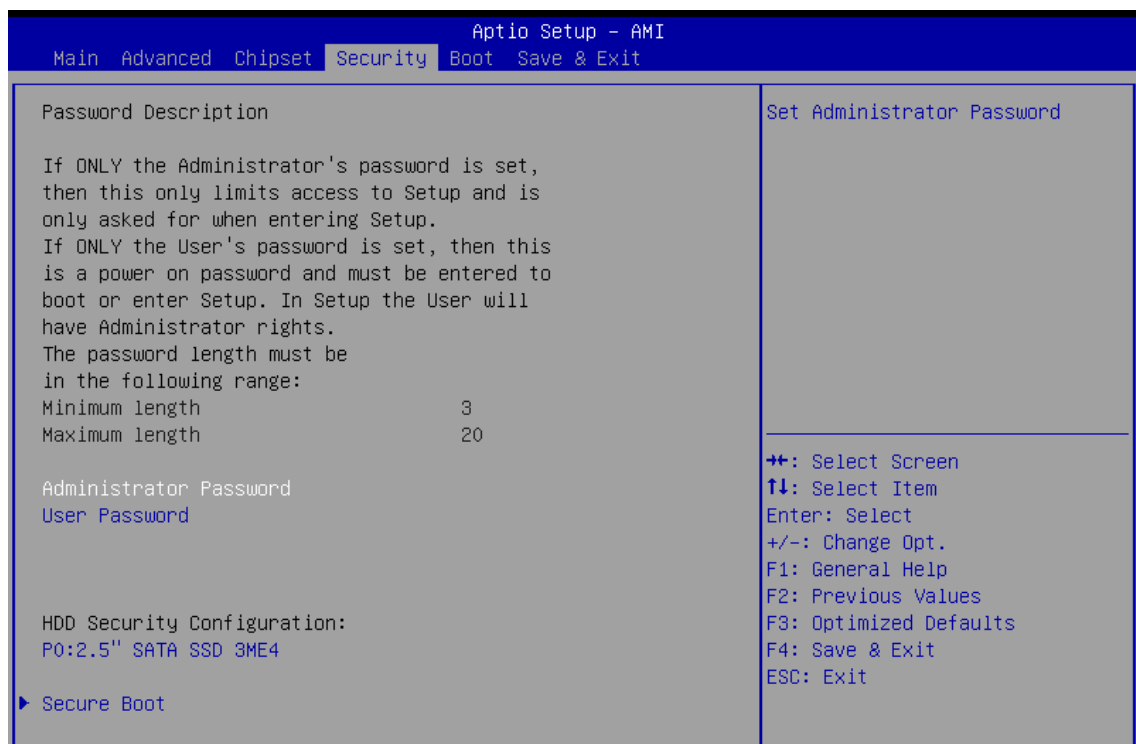

Figure 4-5 : BIOS Security Menu

Administrator Password

Set Administrator Password.

User Password

Set User Password.

4.5.1 HDD Security Configuration

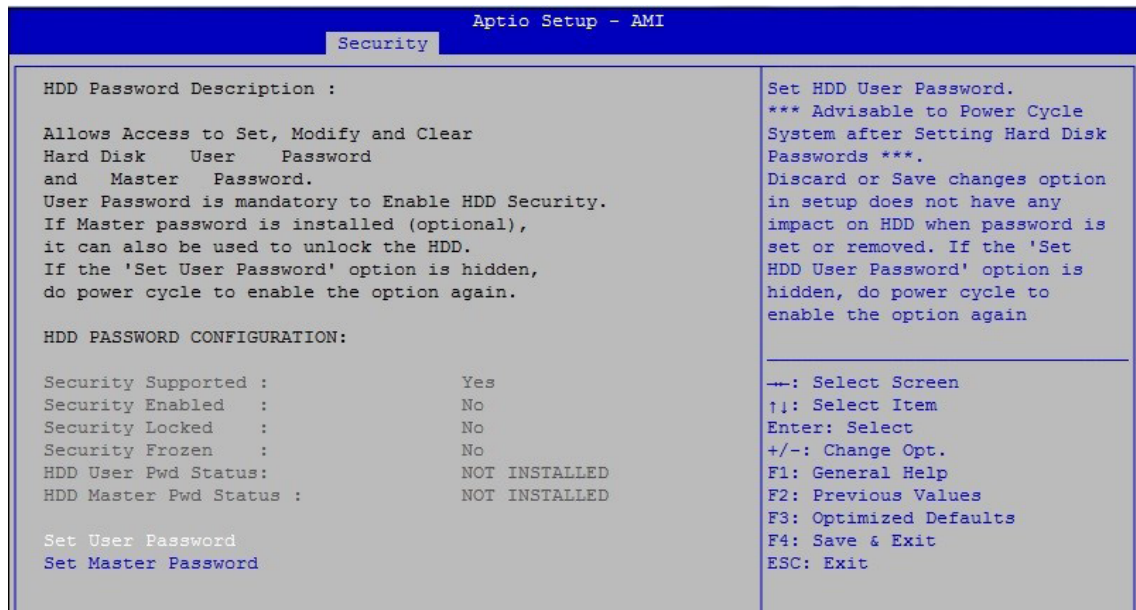

Figure 4-5-1 : HDD Security Configuration

Set User Password

Set HDD User Password.

*** Advisable to Power Cycle System after Setting Hard Disk Passwords ***.

Discard or Save changes option in setup does not have any impact on HDD when password is set or removed. If the 'Set HDD User Password' option is hidden, do power cycle to enable the option again.

4.5.2 Secure Boot



Figure 4-5-2 : Secure Boot

Secure Boot

Secure Boot feature is Active if Secure Boot is Enabled, Platform Key(PK) is enrolled and the System is in User mode. The mode change requires platform reset.

Secure Boot Mode

Secure Boot mode options: Standard or Custom. In Custom mode, Secure Boot Policy variables can be configured by a physically present user without full authentication.

Key Management

Enables expert users to modify Secure Boot Policy variables without full authentication.

4.6 Boot Function

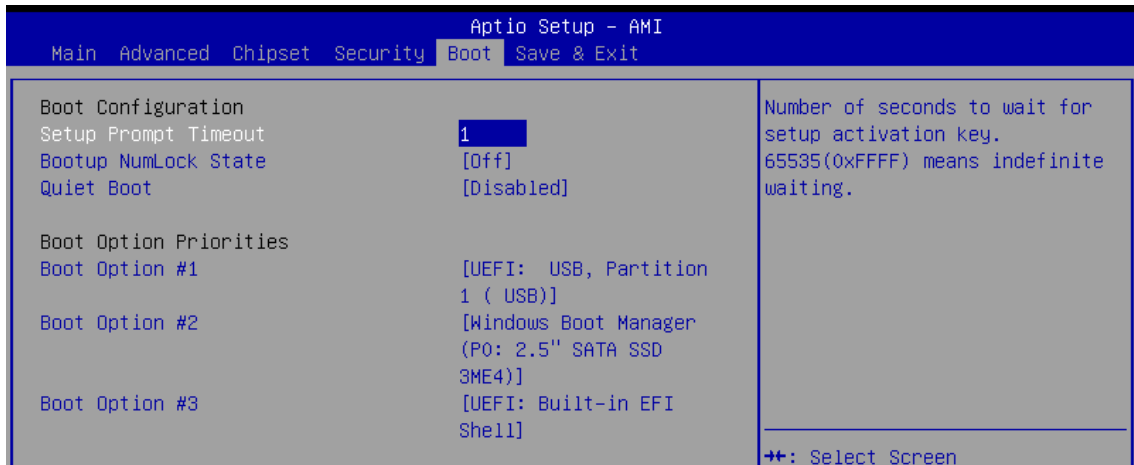

Figure 4-6 : Boot Function

Setup Prompt Timeout

Number of seconds to wait for setup activation key. 65535(0xFFFF) means indefinite waiting.

Bootup NumLock State

Select the keyboard NumLock state.

Quiet Boot

Enables or disables Quiet Boot option.

Boot Option #x

Sets the system boot order.

4.7 Save & Exit

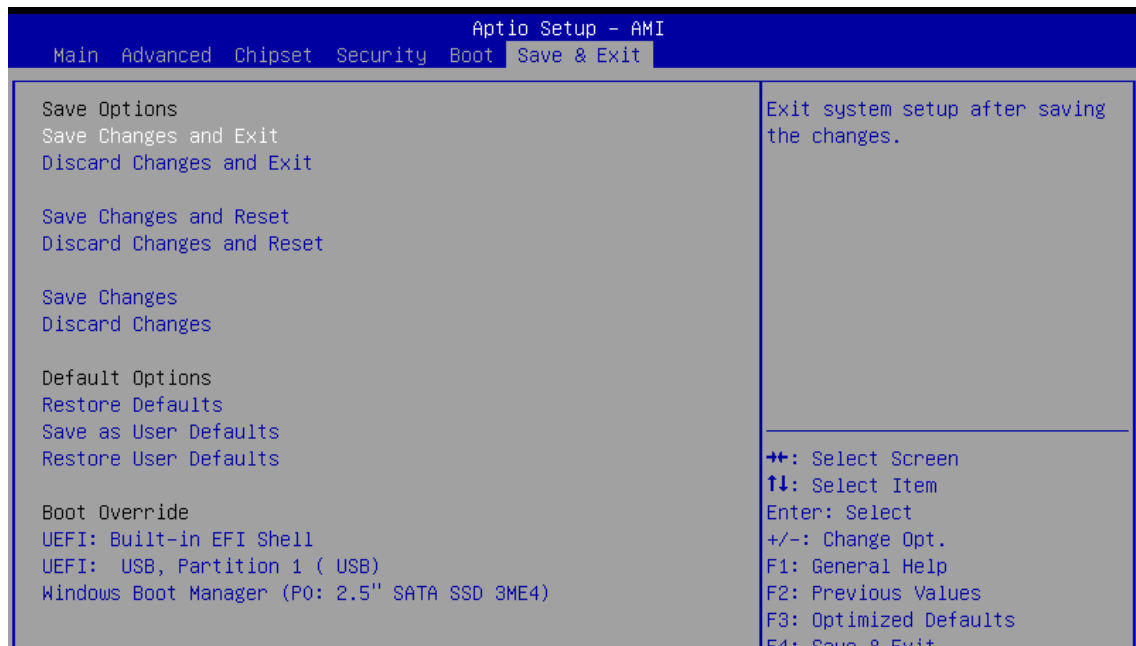

Figure 4-7 : Save & Exit

Save Changes and Exit

Exit system setup after saving the changes.

Discard Changes and Exit

Exit system setup without saving any changes.

Save Changes and Reset

Reset the system after saving the changes.

Discard Changes and Reset

Reset system setup without saving any changes.

Save Changes

Save Changes done so far to any of the setup options.

Discard Changes

Discard Changes done so far to any of the setup options.

Restore Defaults

Restore/Load Default values for all the setup options.

Save as User Defaults

Save the changes done so far as User Defaults.

Restore User Defaults

Restore the User Defaults to all the setup options.

A

APPENDIX A : GPIO Guide

A.1 Function Description

The EPBC-1000 offers a 8-bit GPIO a pair of 10-bit internal connector, and a watchdog timer.

GPIO definition is shown below:

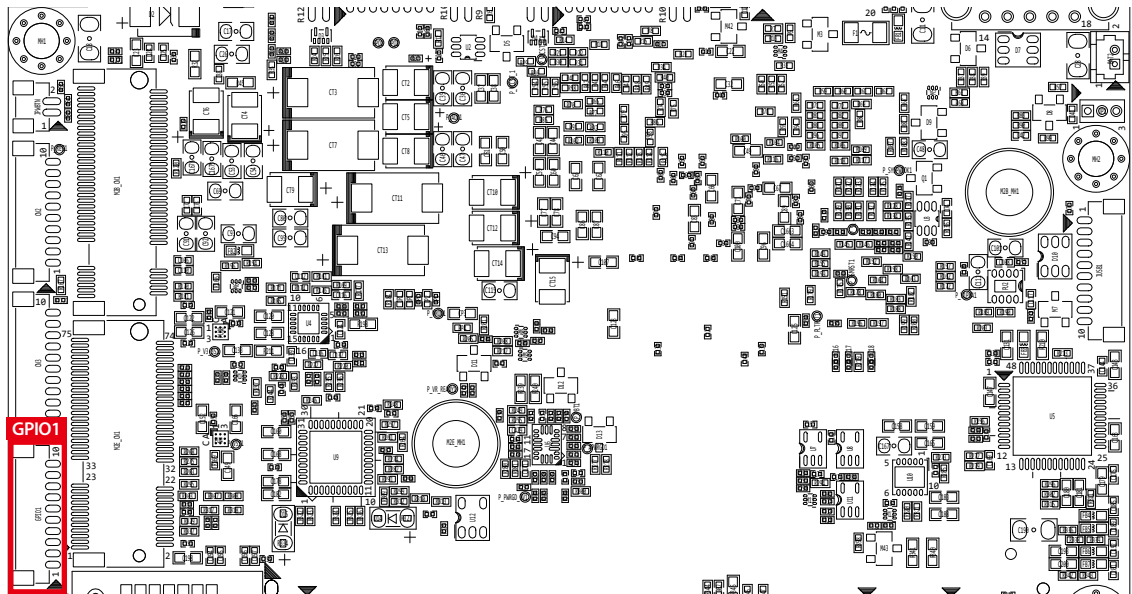

GPIO1	
Pin No.	GPIO Definition
1	GPIO 0
2	GPIO 1
3	GPIO 2
4	GPIO 3
5	GPIO 4
6	GPIO 5
7	GPIO 6
8	GPIO 7
9	+VDIO
10	GND

A.2 Software Package Contain

Distribution folders include x32 and x64 versions, use the batch file for driver installation.

There are included as followed:

Win10_32.bat, and Win10_64.bat:

Installation for driver, and

Uninstall_32.bat, and Uninstall_64.bat:

Uninstallation for driver

Run batch file as Administrator.

Make sure Windows version before installation.

Header folders include head file for software developer or System Integration.

Manual folders include API description.

Sample folders include sample program, driver library, and API library for Windows/Linux

Source folders include sample program source code that compile on Visual Studio 2008/ ubuntu18.04.

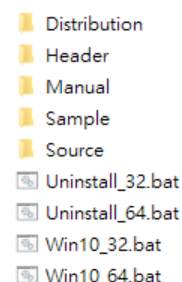

A.3 Sample

Execute demo tool.

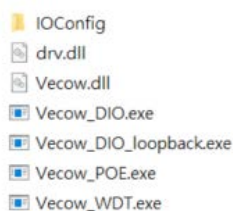

Windows

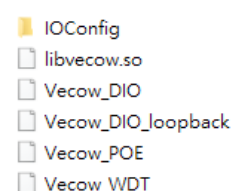

Linux

```
DIO sample version : v1.0.0609.0608
Load Vecow.dll at least v1.8.1409.0608
Vecow.dll Version : v1.8.1409.0608
Config : IO port I - Isolated DIO
         IO port II - Non-Isolated DIO(GPIO)

Choose IO : (1/2)
```

Vecow_DIO

```
DIO loopback sample version : v1.0.1509.0608
Load Vecow.dll at least v1.8.1409.0608
Vecow.dll Version : v1.8.1409.0608
Config : IO port I - Isolated DIO
         IO port II - Non-Isolated DIO(GPIO)

How many IO temp_port : (1/2)
```

Vecow_DIO_loopback

```
WDT sample version : v1.0.0509.0608
Load Vecow.dll at least v1.8.1409.0608
Vecow.dll Version : v1.8.1409.0608
Config : IO port I - Isolated DIO
         IO port II - Non-Isolated DIO(GPIO)

Set WDT timer seconds (1~3932100) :
```

Vecow_WDT

B

APPENDIX B : Software Functions

B.1 Driver API Guide

In Header folder, Vecow.h and VecowLinux.h contain usable API for Windows/Linux.

BOOL initial_SIO(BYTE Isolate_Type, BYTE DIO_NPN)

Initial machine for IO and watch dogtimer.

Isolate_Type: DIO type.

1: Isolated DIO; 0: Non-Isolated DIO(GPIO).

DIO_NPN: DI / DO type.

1: PNP (Source) mode for European rule; 0: NPN (Sink) mode for Japanese rule.

Return:

TRUE (1): Success.

FALSE (0): Fail (Driver not exists, or version is too old, or machine not match).

BOOL get_IO1_configuration

(BYTE *Iso, BYTE *DI_mode, BYTE *DO_mode, WORD *Mask)

BOOL get_IO2_configuration

(BYTE *Iso, BYTE *DI_mode, BYTE *DO_mode, WORD *Mask)

Get DIO configuration (by variable)

Isolate_Type: DIO type.

1: Isolated DIO; 0: Non-Isolated DIO(GPIO).

DI_mode ([7:0]): DI type, pin setting by hexadecimal bitmask only for Isolated DIO.

0xFF: PNP (Source) mode for European rule; 0: NPN (Sink) mode for Japanese rule.

DO_mode: DO type only for Isolated DIO.

1: PNP (Source) mode for European rule; 0: NPN (Sink) mode for Japanese rule.

Mask ([15:0]): In / Out, pin setting by hexadecimal bitmask only for Non-Isolated DIO(GPIO).

1: Output; 0: Input

Return :

TRUE (1): Success.

FALSE (0): Fail (Initial error, or call by pointer error, or hardware problem).

BBOOL set_IO1_configuration

(BYTE Iso, BYTE DI_mode, BYTE DO_mode, WORD Mask)

BOOL set_IO2_configuration

(BYTE Iso, BYTE DI_mode, BYTE DO_mode, WORD Mask)

Set DIO configuration.

Isolate_Type: DIO type.

1: Isolated DIO; 0: Non-Isolated DIO(GPIO).

DI_mode ([7:0]): DI type, pin setting by hexadecimal bitmask only for Isolated DIO.

0xFF: PNP (Source) mode for European rule; 0: NPN (Sink) mode for Japanese rule.

DO_mode: DO type only for Isolated DIO.

1: PNP (Source) mode for European rule; 0: NPN (Sink) mode for Japanese rule.

Mask ([15:0]): In / Out, pin setting by hexadecimal bitmask only for Non-Isolated DIO(GPIO).

1: Output; 0: Input

Return:

TRUE (1): Success.

FALSE (0): Fail (Initial error or hardware problem).

BOOL get_GPIO1(WORD *GPIO_data)

Get GPIO

GPIO_data ([15:0]): GPIO state, pin setting by hexadecimal bitmask.

1: High; 0: Low.

Return :

TRUE (1): Success.

FALSE (0): Fail (Initial error or hardware problem).

BOOL set_GPIO1(WORD GPIO_data)

Set GPIO

GPIO_data ([15:0]): GPIO state, pin setting by hexadecimal bitmask.

1: High; 0: Low

Return:

TRUE (1): Success;

FALSE (0): Fail (Initial error, or hardware problem)

BOOL get_WDT(DWORD *WDT)

Get watchdog timer setup

WDT: watchdog timer setup

Unit: second. (Range: 0 ~ 65535 sec, 1093 ~ 65535 min (=65580 ~ 3932100 sec))

Return:

TRUE (1): Success;

FALSE (0): Fail (Initial error, or call by pointer error, or hardware problem)

BOOL Set_WDT(DWORD WDT)

Set watchdog timer setup

WDT: watchdog timer setup

Unit: second. (Range: 0 ~ 65535 sec, 1093 ~ 65535 min (=65580 ~ 3932100 sec))

Return:

TRUE (1): Success;

FALSE (0): Fail (Initial error, or setup 0, or hardware problem)

BOOL Cancel_WDT()

Cancel watchdog timer

Return:

TRUE (1): Success;

FALSE (0): Fail (Initial error, or hardware problem)

BOOL config_COMPORT(BYTE *PORT_NUM)

Set COMPORT configuration.

A. PORT_NUM: Usable COMPORT number.

Range: 1~2.

Return:

TRUE (1): Success;

FALSE (0): Fail (Initial error, or setup 0, or hardware problem)

BOOL set_COMPORT_mode(BYTE port, BYTE mode, BYTE term)

Set COMPORT mode.

B. port: which port set.

Range: 1~2.

C. mode: Usable COMPORT number.

0: RS232 mode; 1: RS422-5Wire mode.

2: RS422-9Wire mode; 4: RS485 mode.

4: Loopback mode.

D. term: Termination enable for RS422/RS485 mode.

1: Enable; 0: Disable.

Return:

TRUE (1): Success;

FALSE (0): Fail (Initial error or hardware problem)

BOOL get_COMPORT_mode(BYTE port, BYTE *mode, BYTE term)

Get COMPORT mode.

E. port: which port get.

Range: 1~2.

F. mode: Usable COMPORT number.

0: RS232 mode; 1: RS422-5Wire mode.

2: RS422-9Wire mode; 4: RS485 mode.

4: Loopback mode.

G.term: Termination enable for RS422/RS485 mode.

1: Enable; 0: Disable.

Return:

TRUE (1): Success;

FALSE (0): Fail (Initial error or hardware problem)



APPENDIX C : Power Consumption

Testing Board	PBC-1000
RAM	16GB * 1
USB-1 : (USB 2.0)	USB Micsoft Wired Keyboard 600
USB-2 : (USB 2.0)	USB Mouse HP G1K28AA
SATA 0	Apacer SATA AP120GAS340XC
SATA 1	Kingston SA400MB/480GB
LAN 1 (RTL8119I)	1.0 Gbps
LAN 2 (RTL8119I)	1.0 Gbps
Graphics Output	DP
Power Plan	Balance (Windows10 Power plan)
Power Source :	Chroma 62006P-100-25

C.1 Intel Atom® x6211E Processor 1.5M Cache, up to 3.00 GHz

CPU	Power Input	Standby Mode		Power on and boot to Win10 64bit			
				Sleep Mode		idle status CPU usage less 3%	
		Max Current	Max Consumption	Max Current	Max Consumption	Max Current	Max Consumption
Intel Atom® x6211E	12V	0.129A	01.54W	0.137A	01.65W	0.798A	09.57W

CPU	Power Input	Power on and boot to Win10 64bit			
		Run 100% CPU usage without 2D		Run 100% CPU usage with 3D	
		Max Current	Max Consumption	Max Current	Max Consumption
Intel Atom® x6211E	12V	0.889A	10.67W	0.940A	11.28W

D

APPENDIX D : Supported Memory & Storage List

D.1 Test Item

Testing Board	PBC-1000
Memory Test	MemTest86 V9.3
BurnIn Test	BurnInTest Pro V9.2 (build 1009)

Channel	Memory Test	Burn-in Test	Flash BIOS	Remove Battery	Sleep	Hibernate	Reboot	HWINFO64
*1(DIMM 1)	PASS	PASS	PASS	PASS	PASS	PASS	PASS	PASS

D.2 Supported Non-ECC Memory List

Brand	Info	Test Temp. (Celsius)
innodisk 16G DDR4-2400 SO-DIMM	M4D0-AGS1Q5SJ-H03	25°C
innodisk 4G DDR4-2666 SO-DIMM	M4S0-4GSSNCIK-H03	25°C
MemxPro 16G DDR4-2666 SO-DIMM	D4S-AG26H1G8W2	25°C
SL-Link 32GB DDR4-3200 SODIMM	J4BGSH2G8TMFC	25°C
Smart 16GB DDR4-3200 SODIMM	ST2046SO410825-SE	25°C

D.3 Supported Storage List

Type	Vendor	Model	Capacity
M.2 SSD	innodisk	M.2 (P42) 3TE6	256GB
SATA SSD	Transcend	SSD370 TS64GSSD370	64GB
	innodisk	3MG2-P DGS25-64GD81BC1QC	64GB
		3TE7 DES25-B56DK1GC3QL-H03	256GB
	Kingston	SA400S371120G	120GB
		SUV400S37	120GB
	Intel	SSD E 5400s SSDSC2KR120H6	120GB
	MEMXPRO	M3A MI3MA1212802WN	128GB
	FORESEE	S903S128G	128GB
	FORESEE	S903S256G	256GB
	LITE-ON	K8-L1256	256GB
	LITE-ON	K8-L1512	512GB

** If more help is needed, please contact Vecow Technical Support.**

E

APPENDIX E : Driver install (Unknown Device)

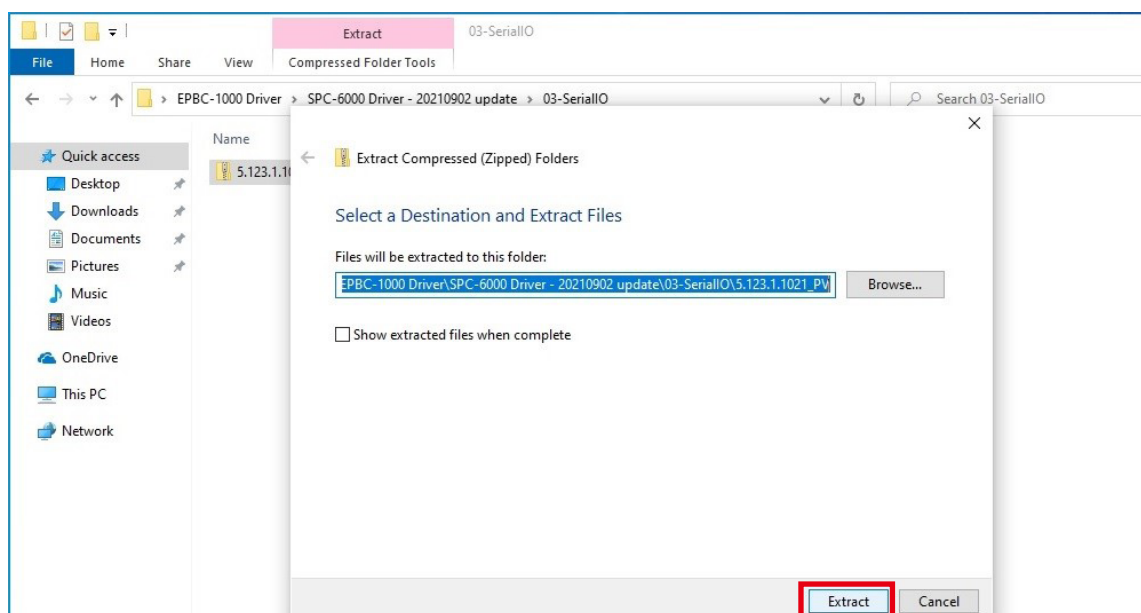
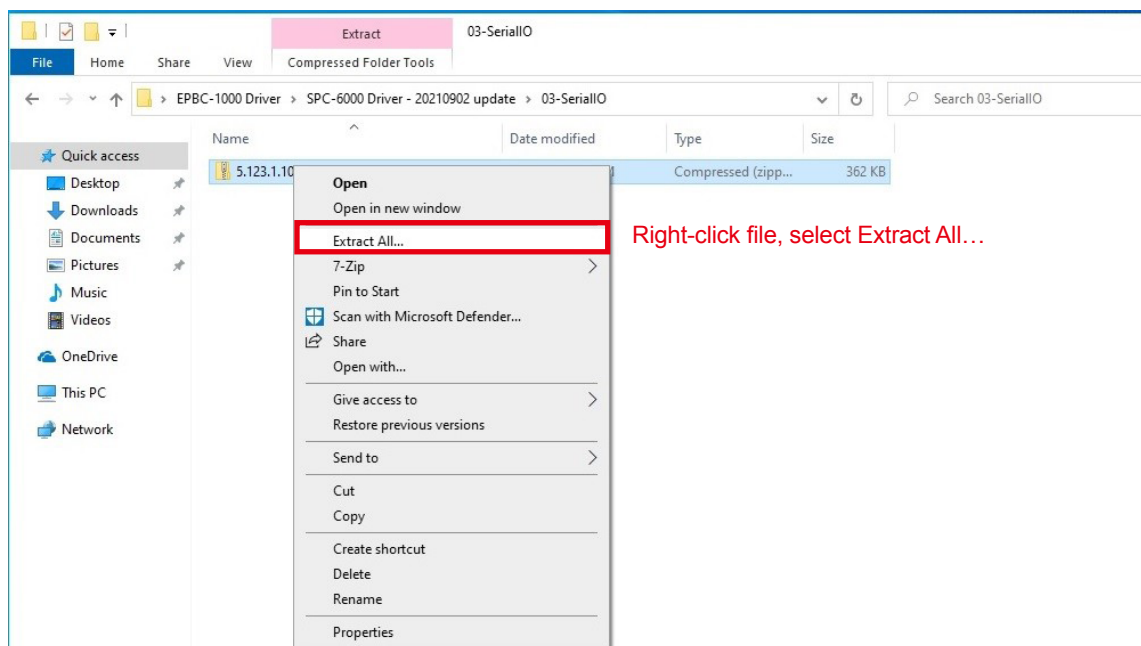

Click Extract

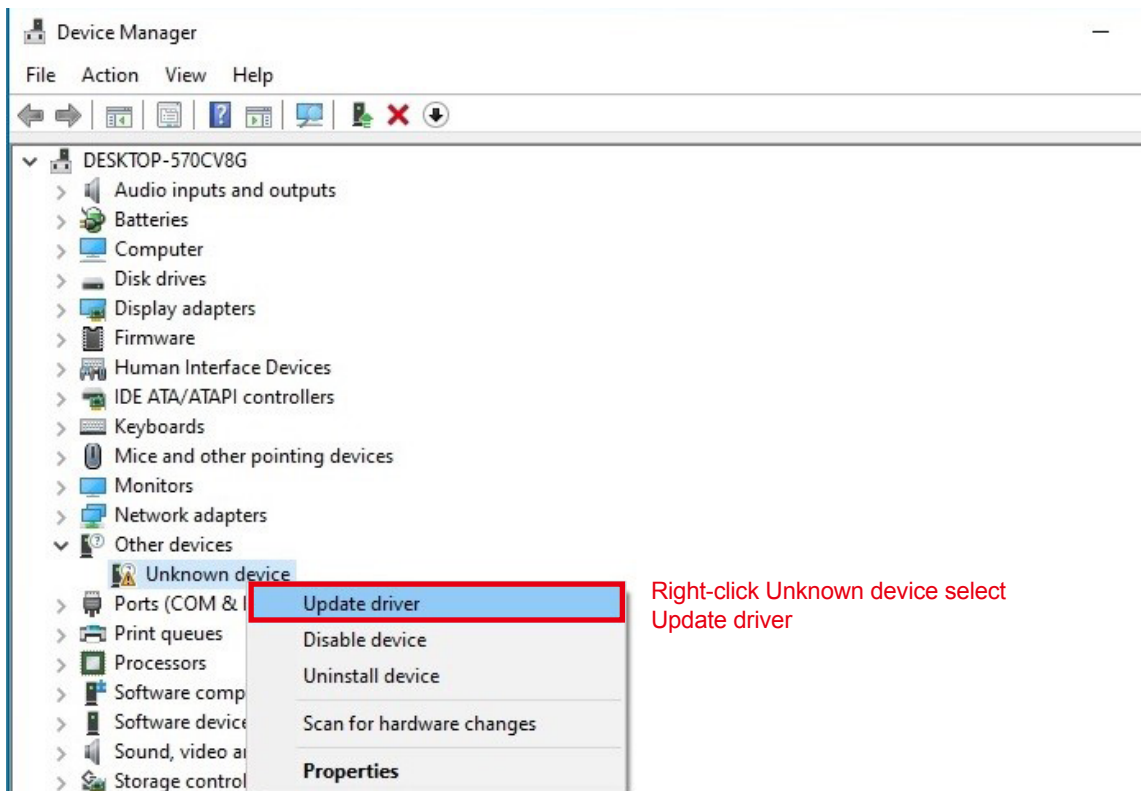
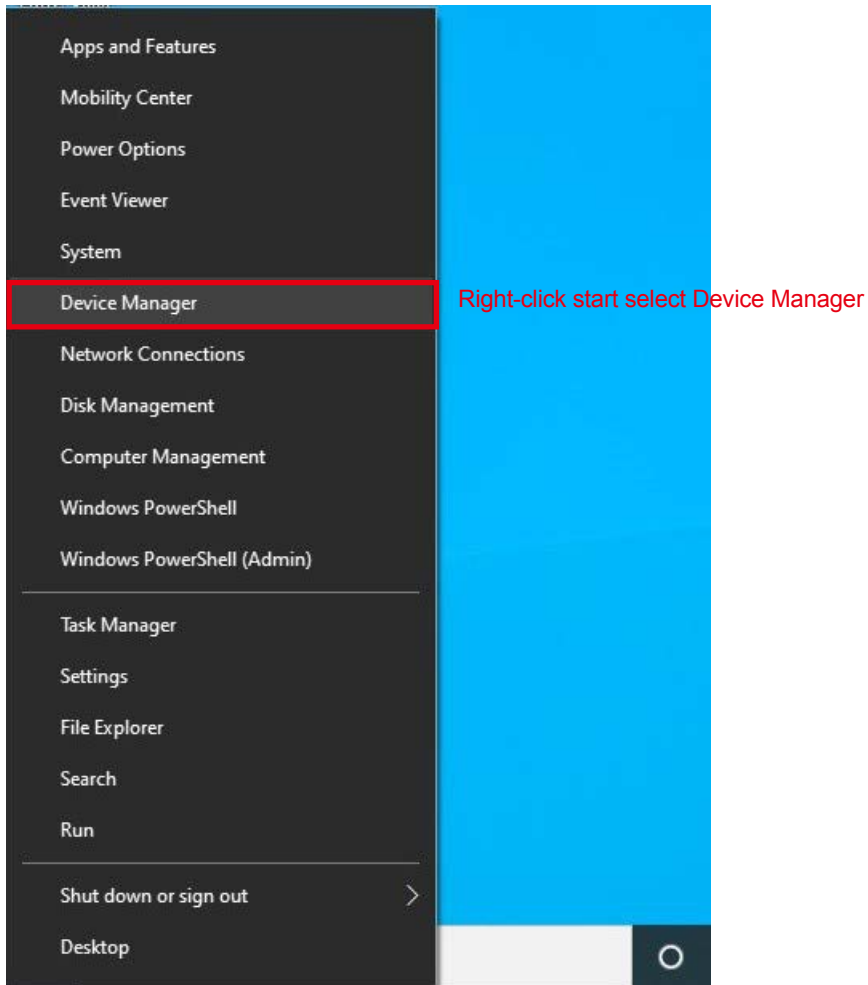

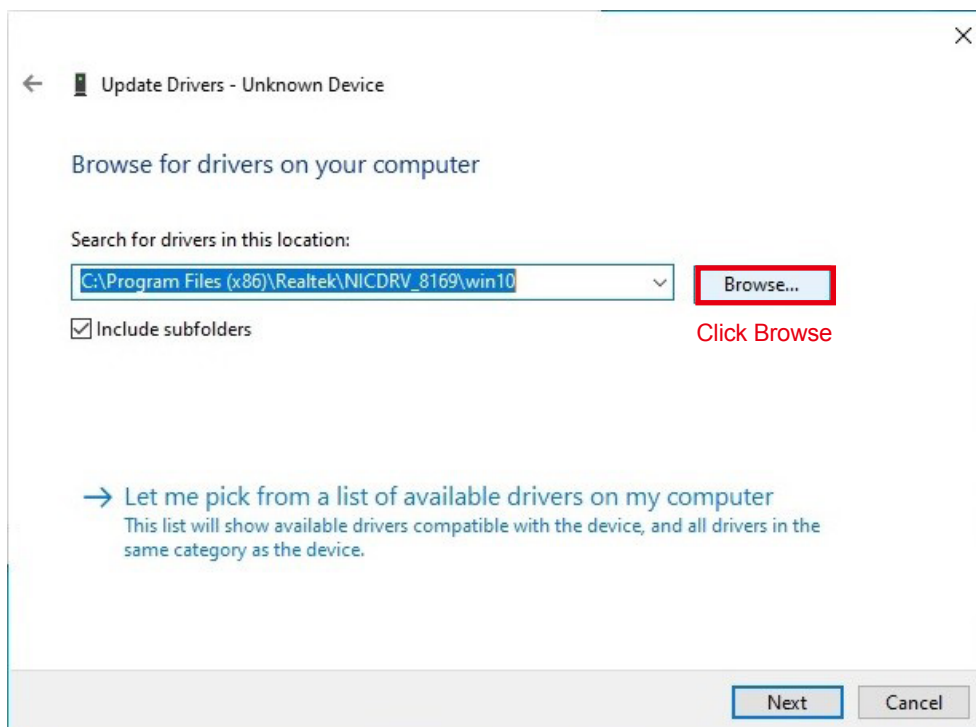
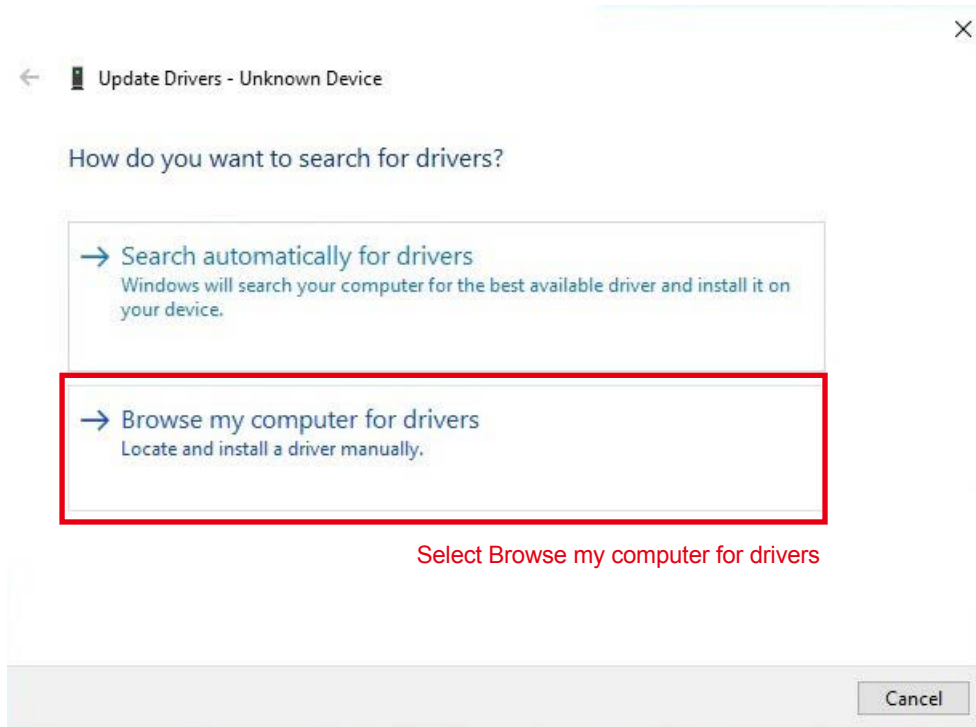

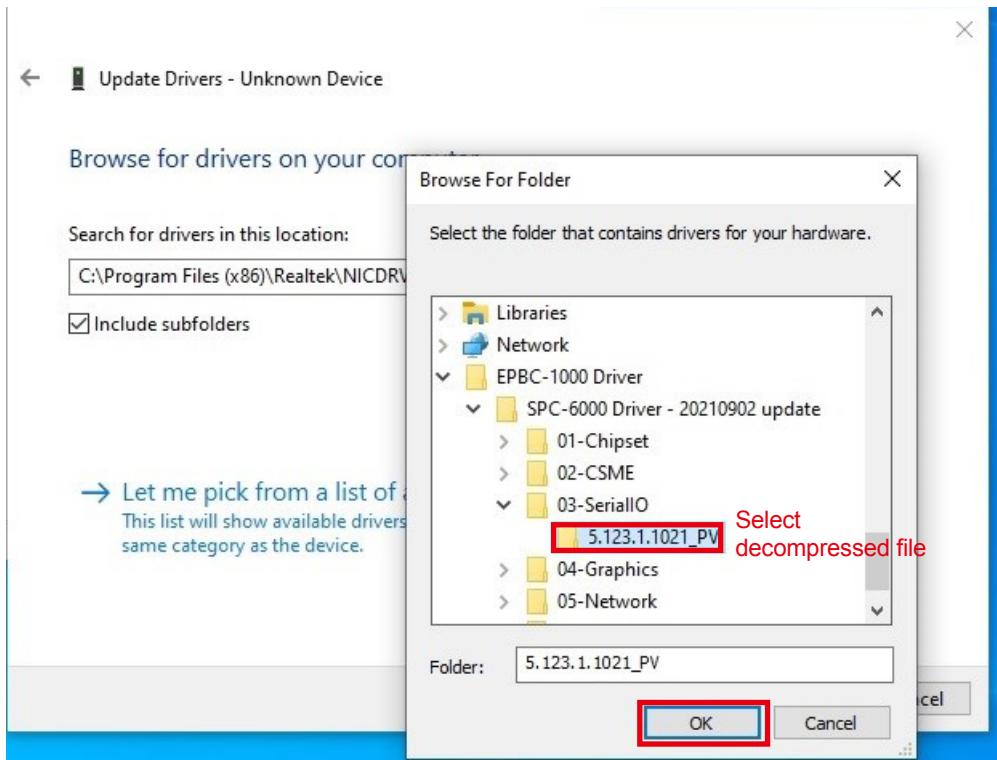

Click OK

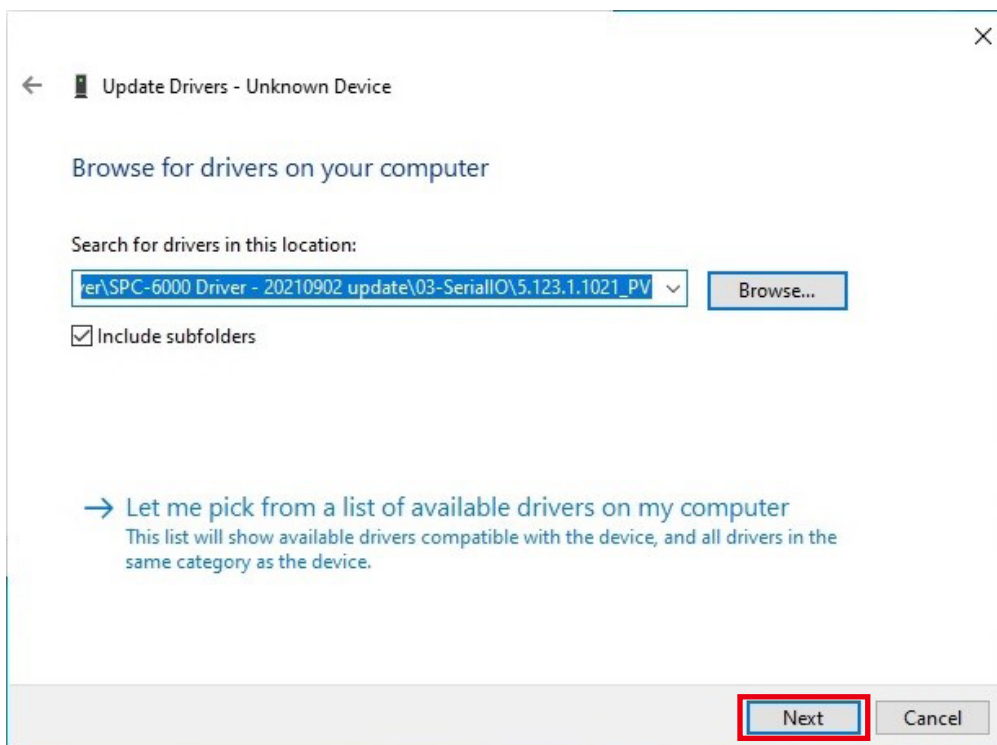

Click Next

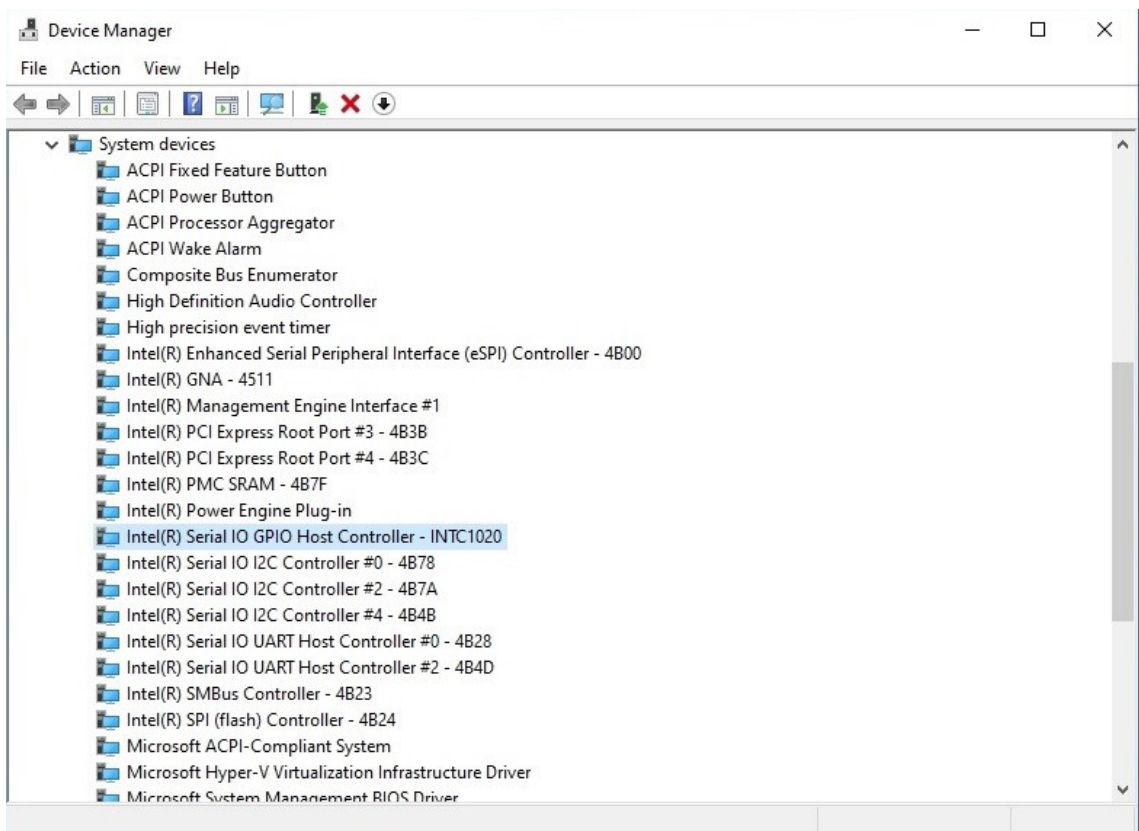
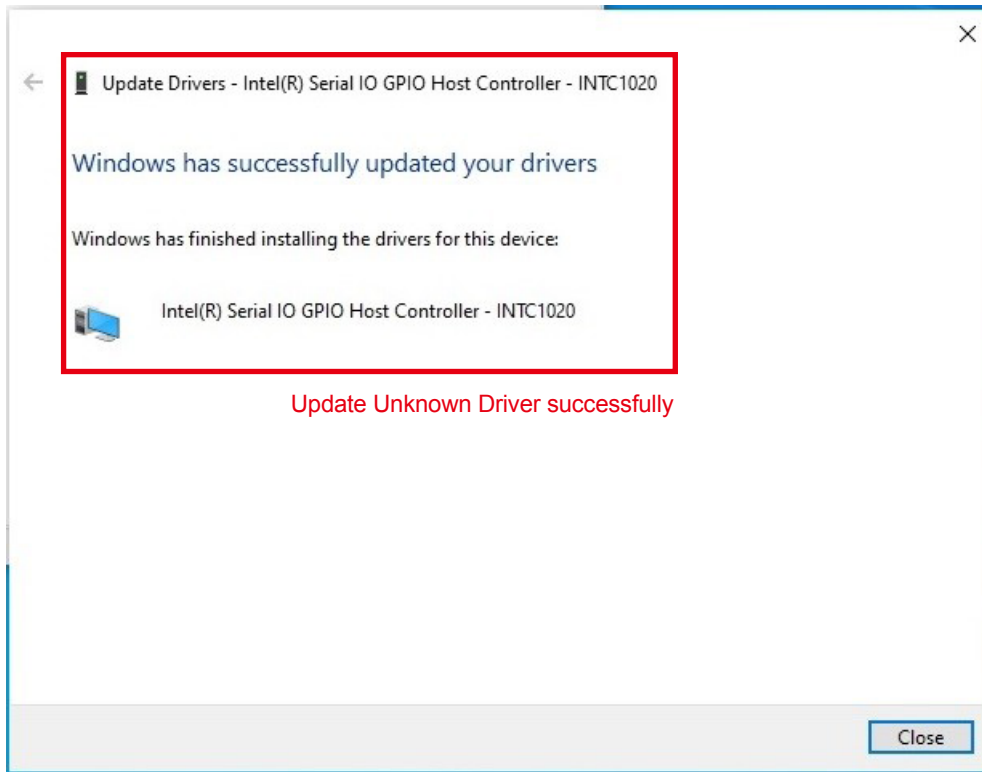



For further support information, please visit www.vecow.com

This document is released for reference purpose only.

All product offerings and specifications are subject to change without prior notice.

No part of this publication may be reproduced in any form or by any means, electric, photocopying, or recording, without prior authorization from the publisher.

The rights of all the brand names, product names, and trademarks belong to their respective owners.

© Vecow Co., Ltd. 2022. All rights reserved.